

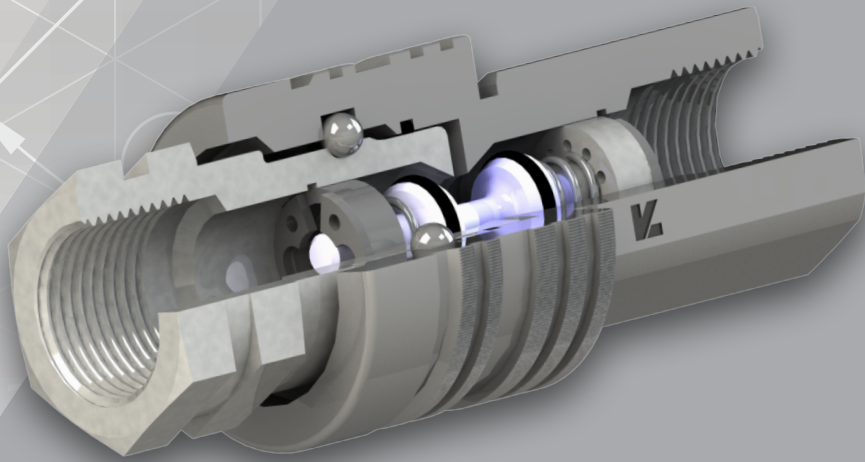

# DMH

## L K F l u i d



# COUPLEURS

[www.dmhfrance.com](http://www.dmhfrance.com)

**SOMMAIRE**

REFERENCE	PAGE	REFERENCE	PAGE
 <b>SOMMAIRE</b>	<b>CPL 2</b>	 <b>CPL A VISSER ROFLEX</b>	<b>CPL 17</b>
 <b>COUPLEURS LK FLUID</b>	<b>CPL 5</b>	 <b>ACCESSOIRES POUR COUPLEURS ROFLEX</b>	<b>CPL 17</b>
 <b>CPL A CLAPET ISO A</b>	<b>CPL 6</b>	 <b>DEMI-VALVES AGRICOLES</b>	<b>CPL 18</b>
 <b>CPL PUSH-PULL ISO A</b>	<b>CPL 7</b>	 <b>ACCESSOIRES POUR DEMI-VALVES AGRICOLE</b>	<b>CPL 18</b>
 <b>POIGNEE D'IDENTIFICATION POUR COUPLEURS</b>	<b>CPL 7</b>	 <b>DEMI-VALVES FREINAGE ISO 5676</b>	<b>CPL 19</b>
 <b>ACCESSOIRES POUR COUPLEURS ISO A</b>	<b>CPL 8</b>	 <b>ACCESSOIRES POUR DEMI-VALVES FREINAGE</b>	<b>CPL 19</b>
 <b>CPL A CLAPET STD / H5</b>	<b>CPL 9</b>	 <b>CPL PASSAGE LIBRE THP</b>	<b>CPL 20</b>
 <b>CPL A CLAPET STD</b>	<b>CPL 9</b>	 <b>COUPLEURS FASTER</b>	<b>CPL 21</b>
 <b>ACCESSOIRES POUR COUPLEURS STD</b>	<b>CPL 10</b>	 <b>CPL A CLAPET ISO A / ANV</b>	<b>CPL 22</b>
 <b>CPL A CLAPET TEMA</b>	<b>CPL 11</b>	 <b>CPL PUSH-PULL ISO A / PV &amp; CPV</b>	<b>CPL 23</b>
 <b>ACCESSOIRES POUR COUPLEURS TEMA</b>	<b>CPL 11</b>	 <b>CPL PUSH-PULL ISO A / CNV</b>	<b>CPL 24</b>
 <b>CPL ANTI-POLLUTION ISO 16028</b>	<b>CPL 12</b>	 <b>CPL PUSH-PULL CSP ISO A / 3CFHF &amp; CNVHF</b>	<b>CPL 25</b>
 <b>CPL 13</b>	<b>CPL 13</b>	 <b>CPL ANTI-POLLUTION CSP ISO 16028</b>	<b>CPL 26</b>
 <b>ACCESSOIRES POUR COUPLEURS ANTI-POLLUTION</b>	<b>CPL 13</b>	 <b>ACCESSOIRES POUR COUPLEURS ISO A</b>	<b>CPL 26</b>
 <b>CPL A VISSER ISO 14541</b>	<b>CPL 14</b>	 <b>CPL A CLAPET STD / NV</b>	<b>CPL 27</b>
 <b>ACCESSOIRES POUR COUPLEURS A VISSER</b>	<b>CPL 15</b>	 <b>CPL A BILLE STD / NS</b>	<b>CPL 28</b>
 <b>CPL A VISSER CAMION</b>	<b>CPL 16</b>	 <b>ACCESSOIRES POUR COUPLEURS STD / NV &amp; NS</b>	<b>CPL 29</b>
 <b>ACCESSOIRES POUR COUPLEURS CAMION</b>	<b>CPL 16</b>	 <b>CPL A CLAPET THP / UHP100</b>	<b>CPL 30</b>

## SOMMAIRE

REFERENCE	PAGE	REFERENCE	PAGE
 CPL A CLAPET ISO B / HNV	CPL 31	 CPL A VISSER CAMION / CVE	CPL 46
 ACCESSOIRES POUR COUPLEURS ISO B / HNV	CPL 32	 ACCESSOIRES POUR COUPLEURS CAMION / CVE	CPL 46
 CPL ANTI-POLLUTION ISO 16028 / FEMELLE FFH	CPL 33	 DEMI-VALVES FREINAGE ISO 5676 / VF	CPL 47
 CPL ANTI-POLLUTION ISO 16028 / MALE FFH	CPL 34	 ACCESSOIRES POUR DEMI-VALVES FREINAGE / VF	CPL 47
 CPL ANTI-POLLUTION CSP ISO 16028 / 3FFH	CPL 35	 CPL FACE PLANE DIAGNOSTIQUE ISO 15171-1 / DF	CPL 48
 ACCESSOIRES POUR COUPLEURS ANTI-POLLUTION / FFH & 3FFH	CPL 36	 ACCESSOIRES POUR COUPLEURS DIAGNOSTIQUE / DF	CPL 48
 CPL ANTI-POLLUTION A VISSER / FHV	CPL 37	 PLATINE 3 COUPLEURS ISO 16028 / 4BD4FH	CPL 49
 ACCESSOIRES POUR COUPLEURS ANTI-POLLUTION A VISSER / FHV	CPL 37	 ACCESSOIRES POUR PLATINE 4BD4FH	CPL 49
 CPL A VISSER ISO 14541 / FEM CVV	CPL 38	 <b>PLATINE MULTI-FASTER</b>	CPL 50
 CPL A VISSER ISO 14541 / MALE CVV	CPL 39	 MONTAGE PLATINE	CPL 53
 ACCESSOIRES POUR COUPLEURS A VISSER / CVV	CPL 40	 CPL POUR PLATINE FIXE	CPL 54
 CPL A VISSER DOUBLE FONCTION / VV	CPL 41	 CPL POUR PLATINE MOBILE	CPL 55
 CPL A VISSER THP / VVS	CPL 42	 FICHE ELECTRIQUE	CPL 55
 ACCESSOIRES POUR COUPLEURS A VISSER / VV & VVS	CPL 43	 <b>COUPLEURS STUCCHI</b>	CPL 56
 CPL A VISSER VERIN ISO 14540 / PVVM	CPL 44	 CPL A CLAPET ISO A / BIR	CPL 57
 ACCESSOIRES POUR COUPLEURS A VISSER / PVVM	CPL 44	 CPL PUSH-PULL ISO A / I-IP	CPL 57
 CPL A VISSER CATER / CVC	CPL 45	 CPL A CLAPET STD / IR-V	CPL 58
 ACCESSOIRES POUR COUPLEURS CATER / CVC	CPL 45		

**SOMMAIRE**

REFERENCE	PAGE	REFERENCE	PAGE		
	ACCESSOIRES POUR COUPLEURS STD / IR-V	<b>CPL 58</b>		<b>PLATINES STUCCHI</b>	<b>CPL 71</b>
	CPL A CLAPET ISO B / IRB	<b>CPL 59</b>		PLATINE 2 COUPLEURS ANTI-POLLUTION / DP2	<b>CPL 71</b>
	ACCESSOIRES POUR COUPLEURS ISO B / IRB	<b>CPL 59</b>		ACCESSOIRES POUR PLATINE DP2	<b>CPL 71</b>
	CPL ANTI-POLLUTION ISO 16028 / A	<b>CPL 60</b>		PLATINE 4 COUPLEURS ANTI-POLLUTION / DP4	<b>CPL 72</b>
	CPL ANTI-POLLUTION CSP ISO 16028 / MALE APM	<b>CPL 61</b>		ACCESSOIRES POUR PLATINE DP4	<b>CPL 72</b>
	CPL ANTI-POLLUTION CSP ISO 16028 / FEM A-HD	<b>CPL 61</b>		PLATINE 4 COUPLEURS ANTI-POLLUTION / GR4	<b>CPL 73</b>
	CPL A VISSER ANTI-POLLUTION / VEP-P	<b>CPL 62</b>		ACCESSOIRES POUR PLATINE GR4	<b>CPL 73</b>
	CPL A VISSER ANTI-POLLUTION EXTREME / VEP-HD	<b>CPL 63</b>		PLATINE 5 COUPLEURS ANTI-POLLUTION / GR5	<b>CPL 74</b>
	ACCESSOIRES POUR COUPLEURS A VISSER / VEP-P & VEP-HD	<b>CPL 64</b>		ACCESSOIRES POUR PLATINE GR5	<b>CPL 74</b>
	CPL A VISSER ANTI-POLLUTION RENFORCE / VP-P	<b>CPL 65</b>		PLATINE 6 COUPLEURS ANTI-POLLUTION / GR6	<b>CPL 75</b>
	ACCESSOIRES POUR COUPLEURS A VISSER / VP-P	<b>CPL 66</b>		ACCESSOIRES POUR PLATINE GR6	<b>CPL 75</b>
	CPL A VISSER ISO 14541 / VD	<b>CPL 67</b>		PLATINE 10 COUPLEURS ANTI-POLLUTION / GR10	<b>CPL 76</b>
	CPL A VISSER OIL & GAS / VOF	<b>CPL 68</b>		ACCESSOIRES POUR PLATINE GR10	<b>CPL 76</b>
	CPL A VISSER "ROHRLEITUNG" / VR	<b>CPL 69</b>		CPL PLATINE ANTI-POLLUTION CSP / FEMELLE FAP	<b>CPL 77</b>
	CPL A VISSER VERIN ISO 14540 / IV-HP	<b>CPL 70</b>		CPL PLATINE ANTI-POLLUTION CSP / MALE FAP	<b>CPL 78</b>
	ACCESSOIRES POUR COUPLEURS A VISSER / IV-HP	<b>CPL 70</b>		FICHE ELECTRIQUE / EC	<b>CPL 79</b>

# COUPLEURS LK FLUID

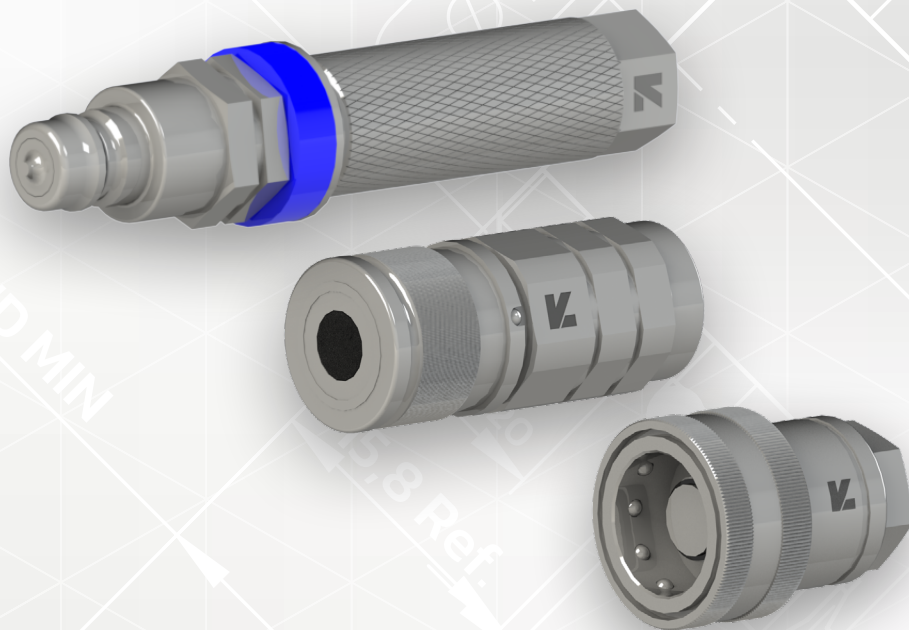

**CPL A CLAPET ISO A**

Référence	Corps	F	A	D	H	Débit maxi (L/m)	PN (bar)
<b>BSPP &gt;&gt;&gt;</b>							
CH-CFC1/4-ISO-A	1/4"	F 1/4"	49,2	26,0	19	17	350
CH-CFC3/8-ISO-A	3/8"	F 3/8"	60,5	30,5	22	46	350
CH-CFC1/2-ISO-A	1/2"	F 1/2"	68,5	38,0	27	90	250
CH-CFC3/4-ISO-A	3/4"	F 3/4"	84,1	46,0	34	190	250
CH-CFC1-ISO-A	1"	F 1"	99,5	52,0	41	280	250
CH-CFC1.1/4-ISO-A	1"1/4	F 1"1/4	116,0	69,5	50	480	200
CH-CFC1.1/2-ISO-A	1"1/2	F 1"1/2	134,7	82,0	60	757	190
CH-CFC2-ISO-A	2"	F 2"	160,0	99,0	75	1000	160

Référence	Corps	F	A	ØAcc	H	Débit maxi (l/m)	PN (bar)
<b>BSPP &gt;&gt;&gt;</b>							
CH-CMC1/4-ISO-A	1/4"	F 1/4"	35,0	11,8	19	17	350
CH-CMC3/8-ISO-A	3/8"	F 3/8"	42,5	17,3	22	35	350
CH-CMC1/2-ISO-A	1/2"	F 1/2"	46,5	20,5	27	90	250
CH-CMC3/4-ISO-A	3/4"	F 3/4"	57,1	29,1	34	190	250
CH-CMC1-ISO-A	1"	F 1"	65,5	34,3	41	280	250
CH-CMC1.1/4-ISO-A	1"1/4	F 1"1/4	74,0	45,0	50	480	200
CH-CMC1.1/2-ISO-A	1"1/2	F 1"1/2	84,0	55,0	60	757	190
CH-CMC2-ISO-A	2"	F 2"	100,0	65,1	75	1000	160
<b>DIN 24° &gt;&gt;&gt;</b>							
CH-CMC3/8UM08LISOA	3/8"	O8L - M14X150	44,0	17,3	22	35	350

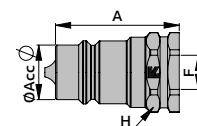
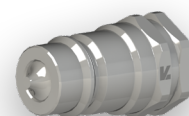
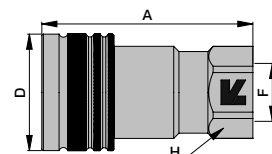
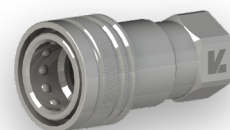

**MATIÈRE**  
Acier - CR3

**JOINT**  
NBR - PTFE

**TEMPÉRATURE DE SERVICE**  
-25 à +125 °C

**INTERCHANGEABLE**  
Selon ISO 7241-A

## CPL PUSH-PULL ISO A

Référence	Corps	F	A	D	H	Débit maxi (l/m)	PN (bar)
<b>BSPP &gt;&gt;&gt;</b>							
CH-CFC1/2G	1/2"	F 1/2"	70,0	38,0	27	90	250
<b>DIN 24° &gt;&gt;&gt;</b>							
CH-CFC1/2G-UM10L	1/2"	10L - M16X150	66,3	38,0	27	90	250
CH-CFC1/2G-UM12L	1/2"	12L - M18X150	66,3	38,0	27	90	250
CH-CFC1/2G-UM15L	1/2"	15L - M22X150	67,3	38,0	27	90	250
CH-CFC1/2G-UM10LCL	1/2"	10L - M16X150 CL	84,3	38,0	27	90	250
CH-CFC1/2G-UM12LCL	1/2"	12L - M18X150 CL	84,3	38,0	27	90	250
CH-CFC1/2G-UM15LCL	1/2"	15L - M22X150 CL	84,3	38,0	27	90	250

Référence	Corps	F	A	ØAcc	H	Débit maxi (l/m)	PN (bar)
<b>BSPP &gt;&gt;&gt;</b>							
CH-CMC1/2G-UM3/8JE	1/2"	M 3/8" JE	53,5	20,55	27	90	250
<b>DIN 24° &gt;&gt;&gt;</b>							
CH-CMC1/2G-UM08L	1/2"	O8L - M14X150	51,5	20,55	27	90	250
CH-CMC1/2G-UM10L	1/2"	10L - M16X150	52,5	20,55	27	90	250
CH-CMC1/2G-UM12L	1/2"	12L - M18X150	52,5	20,55	27	90	250
CH-CMC1/2G-UM15L	1/2"	15L - M22X150	53,5	20,55	27	90	250
CH-CMC1/2G-UM10LCL	1/2"	10L - M16X150 CL	70,0	20,55	27	90	250
CH-CMC1/2G-UM12LCL	1/2"	12L - M18X150 CL	70,0	20,55	27	90	250
CH-CMC1/2G-UM15LCL	1/2"	15L - M22X150 CL	70,0	20,55	27	90	250

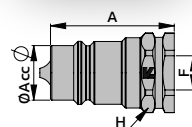
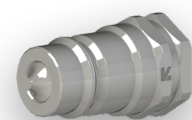
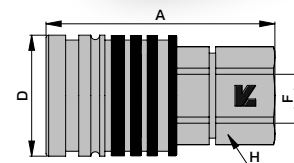
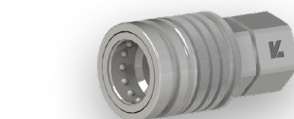

**MATIÈRE**  
Acier - CR3

**JOINT**  
NBR - PTFE

**TEMPÉRATURE DE SERVICE**  
-25 à +125 °C

**INTERCHANGEABLE**  
Selon ISO 7241-A

## POIGNEE D'IDENTIFICATION POUR COUPLEURS

Référence	Description	F	Matière	L
CH-GRIP0808JE-L80	Poignée	1/2"	Acier - ZN	80
CH-GRIP0808JE-ZN	Poignée	1/2"	Acier - ZN	120
CH-GRIP12LR1/2JE-Z	Poignée	1/2" - 12L	Acier - ZN	120

Référence +	Référence -	Description	F	Matière	Couleur
CH-BIDGRIP-B-PL	CH-BIDGRIP-B-MO	Bague d'identification	M30X150	Alu	Bleu
CH-BIDGRIP-J-PL	CH-BIDGRIP-J-MO	Bague d'identification	M30X150	Alu	Jaune
CH-BIDGRIP-R-PL	CH-BIDGRIP-R-MO	Bague d'identification	M30X150	Alu	Rouge
CH-BIDGRIP-V-PL	CH-BIDGRIP-V-MO	Bague d'identification	M30X150	Alu	Vert
CH-BIDGRIP-N-PL	CH-BIDGRIP-N-MO	Bague d'identification	M30X150	Alu	Noir
CH-BIDGRIP-AL-PL	CH-BIDGRIP-AL-MO	Bague d'identification	M30X150	Alu	Alu

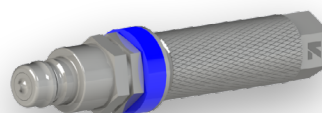
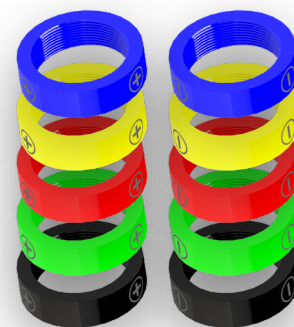
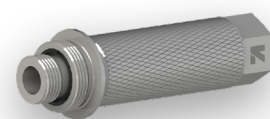

Exemple de montage

CH-GRIP0808JE-ZN ■ CH-BIDGRIP-B-PL ■ CH-CMC1/2-ISO-A

**ACCESSOIRES POUR COUPLEURS ISO A**

Référence	Description	Taille	Pour coupleur	Type	Matière	Couleur
CH-BCFC1/4G	Bouchon	1/4"	Femelle	ISO A	PVC	Rouge
CH-BCFC3/8G	Bouchon	3/8"	Femelle	ISO A	PVC	Rouge
CH-BCFC1/2G	Bouchon	1/2"	Femelle	ISO A	PVC	Rouge
CH-BCFC1/2GB	Bouchon	1/2"	Femelle	ISO A	PVC	Bleu
CH-BCFC1/2GJ	Bouchon	1/2"	Femelle	ISO A	PVC	Jaune
CH-BCFC1/2GN	Bouchon	1/2"	Femelle	ISO A	PVC	Noir
CH-BCFC1/2GV	Bouchon	1/2"	Femelle	ISO A	PVC	Vert
CH-BCFC1/2GAL	Bouchon	1/2"	Femelle	ISO A	Alu	Alu
CH-BCFC3/4G	Bouchon	3/4"	Femelle	ISO A	PVC	Rouge
CH-BCFC1G	Bouchon	1"	Femelle	ISO A	PVC	Rouge
CH-BCFC1.1/4AL	Bouchon	1 1/4"	Femelle	ISO A	Alu	Rouge
CH-BCFC1.1/2AL	Bouchon	1 1/2"	Femelle	ISO A	Alu	Rouge
CH-BCFC2AL	Bouchon	2"	Femelle	ISO A	Alu	Rouge

CH-BCMC1/4G	Bouchon	1/4"	Mâle	ISO A	PVC	Rouge
CH-BCMC3/8G	Bouchon	3/8"	Mâle	ISO A	PVC	Rouge
CH-BCMC1/2G	Bouchon	1/2"	Mâle	ISO A	PVC	Rouge
CH-BCMC1/2GB	Bouchon	1/2"	Mâle	ISO A	PVC	Bleu
CH-BCMC1/2GJ	Bouchon	1/2"	Mâle	ISO A	PVC	Jaune
CH-BCMC1/2GN	Bouchon	1/2"	Mâle	ISO A	PVC	Noir
CH-BCMC1/2GV	Bouchon	1/2"	Mâle	ISO A	PVC	Vert
CH-BCMC1/2GAL	Bouchon	1/2"	Mâle	ISO A	Alu	Alu
CH-BCMC3/4G	Bouchon	3/4"	Mâle	ISO A	PVC	Rouge
CH-BCMC1G	Bouchon	1"	Mâle	ISO A	PVC	Rouge
CH-BCMC1.1/4AL	Bouchon	1 1/4"	Mâle	ISO A	Alu	Rouge
CH-BCMC1.1/2AL	Bouchon	1 1/2"	Mâle	ISO A	Alu	Rouge
CH-BCMC2AL	Bouchon	2"	Mâle	ISO A	Alu	Rouge

Référence	Description	Taille	Filetage	Pour coupleur	Type	Matière	Couleur
CH-DOCK08M18-P-B	Bouchon support	1/2"	M18X150	Mâle	ISO A	Plastique	Bleu
CH-DOCK08M18-P-J	Bouchon support	1/2"	M18X150	Mâle	ISO A	Plastique	Jaune
CH-DOCK08M18-P-R	Bouchon support	1/2"	M18X150	Mâle	ISO A	Plastique	Rouge
CH-DOCK08M18-P-V	Bouchon support	1/2"	M18X150	Mâle	ISO A	Plastique	Vert
CH-DOCK08M18-P-N	Bouchon support	1/2"	M18X150	Mâle	ISO A	Plastique	Noir
CH-DOCK08M18-ZN	Bouchon support nu	1/2"	M18X150	Mâle	ISO A	Acier	ZN
CH-CIDOCK08-B	Clapet d'identification	1/2"	-	Mâle	ISO A	Plastique	Bleu
CH-CIDOCK08-J	Clapet d'identification	1/2"	-	Mâle	ISO A	Plastique	Jaune
CH-CIDOCK08-R	Clapet d'identification	1/2"	-	Mâle	ISO A	Plastique	Rouge
CH-CIDOCK08-V	Clapet d'identification	1/2"	-	Mâle	ISO A	Plastique	Vert
CH-CIDOCK08-N	Clapet d'identification	1/2"	-	Mâle	ISO A	Plastique	Noir

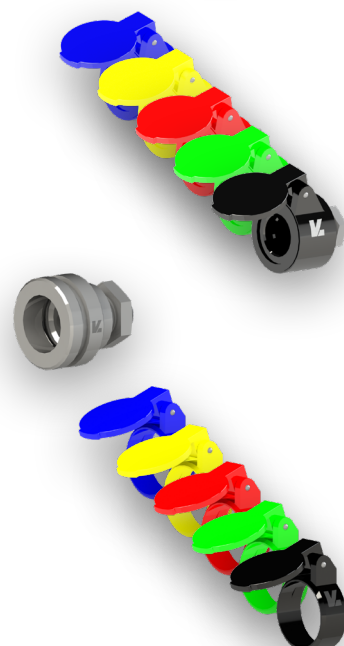

**CPL A CLAPET STD / H5**

Référence	Corps	F	A	D	H	Débit maxi (l/m)	PN (bar)
<b>BSPP &gt;&gt;&gt;</b>							
CH-CFC1/4-H5-ZN	1/4"	F 1/4"	50,0	28,0	19	12	700
CH-CFC3/8-H5-ZN	3/8"	F 3/8"	59,0	34,0	23	17	600
CH-CFC1/2-H5-ZN	1/2"	F 1/2"	69,0	38,0	27	26	500
CH-CFC3/4-H5-ZN	3/4"	F 3/4"	89,0	48,0	35	55	400
CH-CFC1-H5-ZN	1"	F 1"	99,0	52,0	41	87	300

Référence	Corps	F	A	ØAcc	H	Débit maxi (l/m)	PN (bar)
<b>BSPP &gt;&gt;&gt;</b>							
CH-CMC1/4-H5-ZN	1/4"	F 1/4"	35,0	14,2	19	12	700
CH-CMC3/8-H5-ZN	3/8"	F 3/8"	42,0	19,0	23	17	600
CH-CMC1/2-H5-ZN	1/2"	F 1/2"	50,0	20,6	27	26	500
CH-CMC3/4-H5-ZN	3/4"	F 3/4"	63,0	27,9	35	55	400
CH-CMC1-H5-ZN	1"	F 1"	71,0	32,4	41	87	300

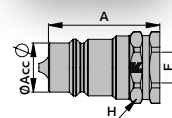
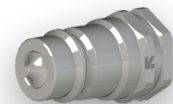
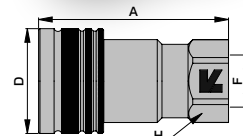
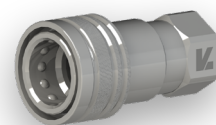

**MATIÈRE**  
Acier - ZN

**JOINT**  
NBR - PTFE

**TEMPÉRATURE DE SERVICE**  
-20 à +100 °C

**INTERCHANGEABLE**  
DN12 interchangeable selon ISO 7241-A

**CPL A CLAPET STD**

Référence	Corps	F	A	D	H	Débit maxi (l/m)	PN (bar)
<b>BSPP &gt;&gt;&gt;</b>							
CH-CFC1/4G	1/4"	F 1/4"	55,5	28,0	19	24	400
CH-CFC3/8G	3/8"	F 3/8"	63,5	35,0	24	46	350
CH-CFC1/2-ISO-A	1/2"	F 1/2"	68,5	38,0	27	90	250
CH-CFC3/4G	3/4"	F 3/4"	84,3	48,0	34	190	250
CH-CFC1G	1"	F 1"	99,5	52,0	41	250	250

Référence	Corps	F	A	ØAcc	H	Débit maxi (l/m)	PN (bar)
<b>BSPP &gt;&gt;&gt;</b>							
CH-CMC1/4G	1/4"	F 1/4"	35,0	14,2	19	24	400
CH-CMC3/8G	3/8"	F 3/8"	42,5	19,0	24	46	350
CH-CMC1/2-ISO-A	1/2"	F 1/2"	46,5	20,6	27	90	250
CH-CMC3/4G	3/4"	F 3/4"	57,5	27,9	34	190	250
CH-CMC1G	1"	F 1"	65,5	31,3	41	250	250

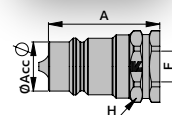
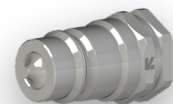
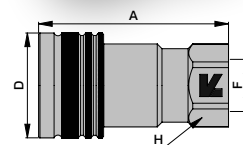
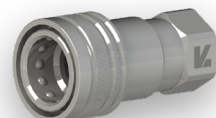

**MATIÈRE**  
Acier - CR3

**JOINT**  
NBR - PTFE

**TEMPÉRATURE DE SERVICE**  
-25 à +125 °C

**INTERCHANGEABLE**  
DN12 interchangeable selon ISO 7241-A

**ACCESSOIRES POUR COUPLEURS STD**

Référence	Description	Taille	Pour coupleur	Type	Matière	Couleur
CH-BCFC1/4G-14.2	Bouchon	1/4"	Femelle	STD	PVC	Rouge
CH-BCFC1/4G-14.2B	Bouchon	1/4"	Femelle	STD	PVC	Bleu
CH-BCFC1/4G-14.2J	Bouchon	1/4"	Femelle	STD	PVC	Jaune
CH-BCFC1/4G-14.2N	Bouchon	1/4"	Femelle	STD	PVC	Noir
CH-BCFC1/4G-14.2V	Bouchon	1/4"	Femelle	STD	PVC	Vert
CH-BCFC3/8G-19	Bouchon	3/8"	Femelle	STD	PVC	Rouge
CH-BCFC1/2G	Bouchon	1/2"	Femelle	ISO A	PVC	Rouge
CH-BCFC1/2GB	Bouchon	1/2"	Femelle	ISO A	PVC	Bleu
CH-BCFC1/2GJ	Bouchon	1/2"	Femelle	ISO A	PVC	Jaune
CH-BCFC1/2GN	Bouchon	1/2"	Femelle	ISO A	PVC	Noir
CH-BCFC1/2GV	Bouchon	1/2"	Femelle	ISO A	PVC	Vert
CH-BCFC1/2GAL	Bouchon	1/2"	Femelle	ISO A	Alu	Alu
CH-BCFC3/4G-28	Bouchon	3/4"	Femelle	STD	PVC	Rouge
CH-BCFC1G-31.3	Bouchon	1"	Femelle	STD	PVC	Rouge



CH-BCMC1/4G-14.2	Bouchon	1/4"	Mâle	STD	PVC	Rouge
CH-BCMC1/4G-14.2B	Bouchon	1/4"	Mâle	STD	PVC	Bleu
CH-BCMC1/4G-14.2J	Bouchon	1/4"	Mâle	STD	PVC	Jaune
CH-BCMC1/4G-14.2N	Bouchon	1/4"	Mâle	STD	PVC	Noir
CH-BCMC1/4G-14.2V	Bouchon	1/4"	Mâle	STD	PVC	Vert
CH-BCMC3/8G-19	Bouchon	3/8"	Mâle	STD	PVC	Rouge
CH-BCMC1/2G	Bouchon	1/2"	Mâle	ISO A	PVC	Rouge
CH-BCMC1/2GB	Bouchon	1/2"	Mâle	ISO A	PVC	Bleu
CH-BCMC1/2GJ	Bouchon	1/2"	Mâle	ISO A	PVC	Jaune
CH-BCMC1/2GN	Bouchon	1/2"	Mâle	ISO A	PVC	Noir
CH-BCMC1/2GV	Bouchon	1/2"	Mâle	ISO A	PVC	Vert
CH-BCMC1/2GAL	Bouchon	1/2"	Mâle	ISO A	Alu	Alu
CH-BCMC3/4G-28	Bouchon	3/4"	Mâle	STD	PVC	Rouge
CH-BCMC1G-31.3	Bouchon	1"	Mâle	STD	PVC	Rouge

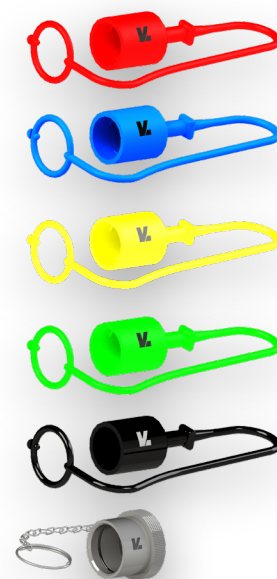

## CPL A CLAPET TEMA

Référence	Corps	F	Série	A	D	H	Débit maxi (l/m)	PN (bar)
<b>BSPP &gt;&gt;&gt;</b>								
CH-CFC3/8G-TEMA-ZN	3/8"	F 3/8"	3811	60,0	35,0	24	90	370
CH-CFC1/2G-TEMA-ZN	1/2"	F 1/2"	5011	65,0	40,0	30	160	350
CH-CFC3/4G-TEMA-ZN	3/4"	F 3/4"	7511	74,5	52,0	38	300	300
CH-CFC1G-TEMA-ZN	1"	F 1"	10011	88,5	62,0	45	500	300

Référence	Corps	F	Série	A	ØAcc	H	Débit maxi (l/m)	PN (bar)
<b>BSPP &gt;&gt;&gt;</b>								
CH-CMC3/8G-TEMA-ZN	3/8"	F 3/8"	3821	38,0	19,95	22	90	370
CH-CMC1/2G-TEMA-ZN	1/2"	F 1/2"	5021	41,5	24,70	27	160	350
CH-CMC3/4G-TEMA-ZN	3/4"	F 3/4"	7521	46,5	32,70	36	300	300
CH-CMC1G-TEMA-ZN	1"	F 1"	10021	54,0	41,00	46	500	300

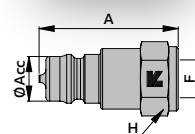
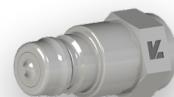
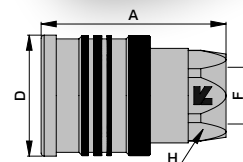
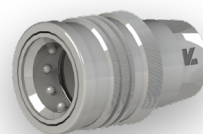

**MATIÈRE**  
Acier - ZN

**JOINT**  
NBR - PTFE

**TEMPÉRATURE DE SERVICE**  
-25 à +125 °C

**ELIMINATEUR DE PRESSION**

## ACCESSOIRES POUR COUPLEURS TEMA

Référence	Description	Taille	Pour coupleur	Type	Matière	Couleur
CH-BCFC3/8G-TEMA	Bouchon	3/8"	Femelle	TEMA	PVC	Rouge
CH-BCFC1/2G-TEMA	Bouchon	1/2"	Femelle	TEMA	PVC	Rouge
CH-BCFC3/4G-TEMA	Bouchon	3/4"	Femelle	TEMA	PVC	Rouge
CH-BCFC1G-TEMA	Bouchon	1"	Femelle	TEMA	PVC	Rouge
CH-BCMC3/8G-TEMA	Bouchon	3/8"	Mâle	TEMA	PVC	Rouge
CH-BCMC1/2G-TEMA	Bouchon	1/2"	Mâle	TEMA	PVC	Rouge
CH-BCMC3/4G-TEMA	Bouchon	3/4"	Mâle	TEMA	PVC	Rouge
CH-BCMC1G-TEMA	Bouchon	1"	Mâle	TEMA	PVC	Rouge



**CPL ANTI-POLLUTION ISO 16028**

Référence	Corps	F	A	D	H	Débit maxi (l/m)	PN (bar)
<b>BSPP &gt;&gt;&gt;</b>							
CH-CFAP04-04-ZN	1/4"	F 1/4"	59,0	28,0	22	24	400
CH-CFAP04-06-ZN	1/4"	F 3/8"	59,0	28,0	22	24	400
CH-CFAP06-06-ZN	3/8"	F 3/8"	74,0	32,0	30	46	350
CH-CFAP06-08-ZN	3/8"	F 1/2"	74,0	32,0	30	46	350
CH-CFAP08-08-ZN	1/2"	F 1/2"	81,5	38,0	36	90	350
CH-CFAP08-12-ZN	1/2"	F 3/4"	81,5	38,0	36	90	350
CH-CFAP10-12-ZN	5/8"	F 3/4"	84,0	42,0	36	150	350
CH-CFAP12-12-ZN	3/4"	F 3/4"	94,5	48,0	41	200	350
CH-CFAP12-16-ZN	3/4"	F 1"	94,5	48,0	41	200	350
CH-CFAP16-16-ZN	1"	F 1"	109,5	55,0	50	280	350
CH-CFAP16-20-ZN	1"	F 1 1/4"	109,5	55,0	55	280	350
CH-CFAP24-24-ZN	1 1/2"	F 1 1/2"	133,0	80,0	65	379	200
CH-CFAP32-32-ZN	2"	F 2"	149,5	103,0	81	757	150
<b>METRIQUE &gt;&gt;&gt;</b>							
CH-CFAP06-16-ZN	3/8"	F 16X150 ISO	74,0	32,0	30	46	350
CH-CFAP06-UM10LCL	3/8"	10L - M16X150 CL	82,0	32,0	30	46	350
CH-CFAP08-UM12L-ZN	1/2"	12L - M18X150	117,5	38,0	36	90	350
CH-CFAP08-UM15L-ZN	1/2"	15L - M22X150	119,5	38,0	36	90	350
<b>SAE &gt;&gt;&gt;</b>							
CH-CFAP08-7/8U-ZN	1/2"	F 7/8" UNF	81,0	38,0	36	90	350

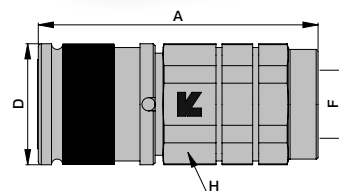
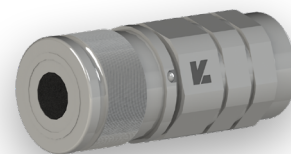

Référence	Corps	F	A	ØAcc	H	Débit maxi (l/m)	PN (bar)
<b>BSPP &gt;&gt;&gt;</b>							
CH-CMAP04-04-ZN	1/4"	F 1/4"	53,3	16,1	22	24	400
CH-CMAP04-06-ZN	1/4"	F 3/8"	53,3	16,1	22	24	400
CH-CMAP06-06-ZN	3/8"	F 3/8"	61,2	19,7	30	46	350
CH-CMAP06-08-ZN	3/8"	F 1/2"	61,2	19,7	30	46	350
CH-CMAP08-08-ZN	1/2"	F 1/2"	74,0	24,5	36	90	350
CH-CMAP08-12-ZN	1/2"	F 3/4"	74,0	24,5	36	90	350
CH-CMAP10-12-ZN	5/8"	F 3/4"	74,0	27,0	36	150	350
CH-CMAP12-12-ZN	3/4"	F 3/4"	87,0	30,0	41	200	350
CH-CMAP12-16-ZN	3/4"	F 1"	87,0	30,0	41	200	350
CH-CMAP16-16-ZN	1"	F 1"	92,0	36,0	50	280	350
CH-CMAP16-20-ZN	1"	F 1 1/4"	92,0	36,0	50	280	350
CH-CMAP24-24-ZN	1 1/2"	F 1 1/2"	120,0	57,0	70	379	200
CH-CMAP32-32-ZN	2"	F 2"	173,2	72,0	80	757	150
<b>METRIQUE &gt;&gt;&gt;</b>							
CH-CMAP06-16-ZN	3/8"	F 16X150 ISO	61,2	19,7	30	46	350
CH-CMAP06-UM10LCL	3/8"	10L - M16X150 CL	79,0	19,7	27	46	350
<b>SAE &gt;&gt;&gt;</b>							
CH-CMAP08-7/8U-ZN	1/2"	F 7/8" UNF	74,0	24,5	36	90	350

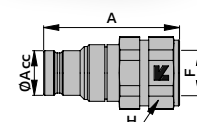
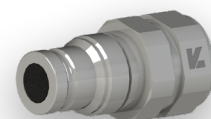

**MATIÈRE**  
Acier - ZN

**JOINT**  
NBR - PTFE

**TEMPÉRATURE DE SERVICE**  
-25 à +125 °C

**INTERCHANGEABLE**  
Selon ISO 16028

**CPL ANTI-POLLUTION CSP ISO 16028**

Référence	Corps	F	A	ØAcc	H	Débit maxi (l/m)	PN (bar)
<b>BSPP &gt;&gt;&gt;</b>							
CH-3CMAPO6-08-ZN	3/8"	F 1/2"	90,2	19,7	30	46	350
CH-3CMAPO8-08-ZN	1/2"	F 1/2"	94,8	24,5	32	90	350
CH-3CMAPO8-12-ZN	1/2"	F 3/4"	94,8	24,5	34	90	350
<b>SAE &gt;&gt;&gt;</b>							
CH-3CMAPO8-7/8U-ZN	1/2"	F 7/8" UNF	94,8	24,5	32	90	350

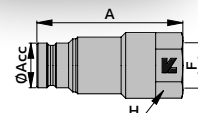
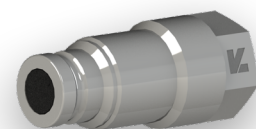

**MATIÈRE**  
Acier - ZN

**JOINT**  
NBR - PTFE

**TEMPÉRATURE DE SERVICE**  
-25 à +125 °C

**INTERCHANGEABLE**  
Selon ISO 16028

**CONNEXION**  
Connectable sous pression

**ACCESSOIRES POUR COUPLEURS ANTI-POLLUTION**

Référence	Description	Taille	Pour coupleur	Type	Matière	Couleur
CH-BCFAP-16.1	Bouchon	1/4"	Femelle	ISO 16028	PVC	Rouge
CH-BCFAP-19.7	Bouchon	3/8"	Femelle	ISO 16028	PVC	Rouge
CH-BCFAP-24.5	Bouchon	1/2"	Femelle	ISO 16028	PVC	Rouge
CH-BCFAP-30	Bouchon	3/4"	Femelle	ISO 16028	PVC	Rouge
CH-BCFAP-36	Bouchon	1"	Femelle	ISO 16028	PVC	Rouge
CH-BCMAP-16.1	Bouchon	1/4"	Mâle	ISO 16028	PVC	Rouge
CH-BCMAP-19.7	Bouchon	3/8"	Mâle	ISO 16028	PVC	Rouge
CH-BCMAP-24.5	Bouchon	1/2"	Mâle	ISO 16028	PVC	Rouge
CH-BCMAP-30	Bouchon	3/4"	Mâle	ISO 16028	PVC	Rouge
CH-BCMAP-36	Bouchon	1"	Mâle	ISO 16028	PVC	Rouge



**CPL A VISSER ISO 14541**

Référence	Corps	F	A	ACC	H	Débit maxi (l/m)	PN (bar)
<b>BSPP &gt;&gt;&gt;</b>							
CH-CFV1/4G-28	3/8"	F 1/4"	64,2	M28X200	24	46	400
CH-CFV3/8G-28	3/8"	F 3/8"	64,2	M28X200	24	46	400
CH-CFV3/8G-36	1/2"	F 3/8"	66,5	M36X200	30	90	400
CH-CFV1/2G-36	1/2"	F 1/2"	66,5	M36X200	30	90	400
CH-CFV1/2G-42	3/4"	F 1/2"	85,0	M42X200	36	190	300
CH-CFV3/4G-42	3/4"	F 3/4"	85,0	M42X200	36	190	300
CH-CFV3/4G-48	1"	F 3/4"	100,0	M48X300	41	280	300
CH-CFV1G-48	1"	F 1"	100,0	M48X300	41	280	300
CH-CFV1.1/4G-70	1"1/4	F 1"1/4	122,0	M70X300	65	480	300
<b>METRIQUE &gt;&gt;&gt;</b>							
CH-CFV1/2G-UM12L	1/2"	12L - M18X150	69,0	M36X200	36	90	400
CH-CFV1/2G-UM12LCL	1/2"	12L - M18X150 CL	80,0	M36X200	36	90	400
CH-CFV1/2G-UM15LCL	1/2"	15L - M22X150 CL	81,0	M36X200	36	90	400

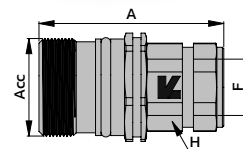
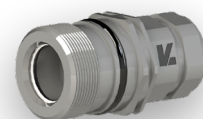

Référence	Corps	F	A	ACC	H	H1	Débit maxi (l/m)	PN (bar)
<b>BSPP &gt;&gt;&gt;</b>								
CH-CMV1/4G-28	3/8"	F 1/4"	49,5	M28X200	24	30	46	400
CH-CMV3/8G-28	3/8"	F 3/8"	49,5	M28X200	24	30	46	400
CH-CMV3/8G-36	1/2"	F 3/8"	53,5	M36X200	30	36	90	400
CH-CMV1/2G-36	1/2"	F 1/2"	53,5	M36X200	30	36	90	400
CH-CMV1/2G-42	3/4"	F 1/2"	68,0	M42X200	36	41	190	300
CH-CMV3/4G-42	3/4"	F 3/4"	68,0	M42X200	36	41	190	300
CH-CMV3/4G-48	1"	F 3/4"	77,0	M48X300	41	50	280	300
CH-CMV1G-48	1"	F 1"	77,0	M48X300	41	50	280	300
CH-CMV1.1/4G-70	1"1/4	F 1"1/4	119,0	M70X300	65	75	480	300
<b>METRIQUE &gt;&gt;&gt;</b>								
CH-CMV1/2G-UM12L	1/2"	12L - M18X150	54,0	M36X200	30	36	90	400
CH-CMV1/2G-UM15LCL	1/2"	15L - M22X150 CL	67,0	M36X200	30	36	90	400
CH-CMV1G-UM25SCL	1"	25S - M36X200 CL	95,0	M48X300	41	50	280	300

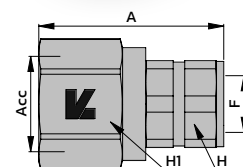
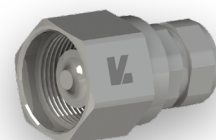

**MATIÈRE**  
Acier - CR3

**JOINT**  
NBR - PTFE

**TEMPÉRATURE DE SERVICE**  
-25 à +125 °C

**INTERCHANGEABLE**  
Selon ISO 14541

**ACCESSOIRES POUR COUPLEURS A VISSER**

Référence	Description	Taille	Pour coupleur	Type	Matière	Couleur
<b>CH-BCFV28</b>	Bouchon	3/8"	Femelle	ISO 14541	PVC	Rouge
<b>CH-BCFV28AL</b>	Bouchon	3/8"	Femelle	ISO 14541	Alu	Alu
<b>CH-BCFV36</b>	Bouchon	1/2"	Femelle	ISO 14541	PVC	Rouge
<b>CH-BCFV36AL</b>	Bouchon	1/2"	Femelle	ISO 14541	Alu	Alu
<b>CH-BCFV42</b>	Bouchon	3/4"	Femelle	ISO 14541	PVC	Rouge
<b>CH-BCFV42AL</b>	Bouchon	3/4"	Femelle	ISO 14541	Alu	Alu
<b>CH-BCFV48</b>	Bouchon	1"	Femelle	ISO 14541	PVC	Rouge
<b>CH-BCFV48AL</b>	Bouchon	1"	Femelle	ISO 14541	Alu	Alu
<b>CH-BCFV70AL</b>	Bouchon	1"1/4	Femelle	ISO 14541	Alu	Alu
<b>CH-BCMV28</b>	Bouchon	3/8"	Mâle	ISO 14541	PVC	Rouge
<b>CH-BCMV28AL</b>	Bouchon	3/8"	Mâle	ISO 14541	Alu	Alu
<b>CH-BCMV36</b>	Bouchon	1/2"	Mâle	ISO 14541	PVC	Rouge
<b>CH-BCMV36AL</b>	Bouchon	1/2"	Mâle	ISO 14541	Alu	Alu
<b>CH-BCMV42</b>	Bouchon	3/4"	Mâle	ISO 14541	PVC	Rouge
<b>CH-BCMV42AL</b>	Bouchon	3/4"	Mâle	ISO 14541	Alu	Alu
<b>CH-BCMV48</b>	Bouchon	1"	Mâle	ISO 14541	PVC	Rouge
<b>CH-BCMV48AL</b>	Bouchon	1"	Mâle	ISO 14541	Alu	Alu
<b>CH-BCMV70AL</b>	Bouchon	1"1/4	Mâle	ISO 14541	Alu	Alu



**CPL A VISSER CAMION**

Référence	Corps	F	A	ACC	H	Débit maxi (l/m)	PN (bar)
<b>BSPP &gt;&gt;&gt;</b>							
CH-CCF3/4	3/4"	F 3/4"	76,0	50	33	240	350
CH-CCF1	1"	F 1"	81,5	60	40	320	300

Référence	Corps	F	A	ACC	H	H1	Débit maxi (l/m)	PN (bar)
<b>BSPP &gt;&gt;&gt;</b>								
CH-CCM3/4	3/4"	F 3/4"	78,0	50	46	50	240	350
CH-CCM1	1"	F 1"	83,0	60	55	50	320	300

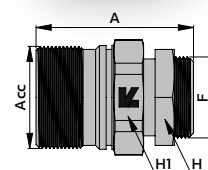
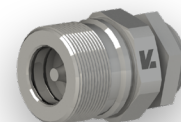
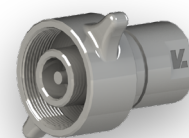

**MATIÈRE**  
Acier - CR3

**JOINT**  
NBR - PTFE

**TEMPÉRATURE DE SERVICE**  
-25 à +125 °C

**ACCESSOIRES POUR COUPLEURS CAMION**

Référence	Description	Taille	Pour coupleur	Type	Matière	Couleur
CH-BCCF3/4	Bouchon	3/4"	Femelle	CAMION	Alu	Alu
CH-BCCF1	Bouchon	1"	Femelle	CAMION	Alu	Alu
CH-BCCM3/4	Bouchon	3/4"	Mâle	CAMION	Alu	Alu
CH-BCCM1	Bouchon	1"	Mâle	CAMION	Alu	Alu



**CPL A VISSER ROFLEX**

Référence	Corps	F	Série	A	ACC	H	Débit maxi (l/m)	PN (bar)
<b>BSPP &gt;&gt;&gt;</b>								
CH-CFV3/8G-RO	3/8"	F 3/8"	5005	77,0	35,6X3	22	68	500
CH-CFV1/2G-RO	1/2"	F 1/2"	5005	95,0	39,6X3	26	90	450
CH-CFV3/4G-RO	3/4"	F 3/4"	5005	99,0	44,7X3	30	170	400
CH-CFV1G-RO	1"	F 1"	5005	106,0	57,6X4	40	312	350
CH-CFV1.1/4G-RO	1 1/4"	F 1 1/4"	5005	118,0	65,5X5	48	425	320
CH-CFV1.1/2G-RO	1 1/2"	F 1 1/2"	5105	121,0	74,5X5	55	625	300
CH-CFV2G-RO	2"	F 2"	5005	165,0	100X5	76	1080	250

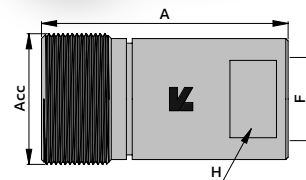

Référence	Corps	F	Série	A	ACC	H	H1	Débit maxi (l/m)	PN (bar)
<b>BSPP &gt;&gt;&gt;</b>									
CH-CMV3/8G-RO	3/8"	F 3/8"	5006	55,0	35,6X3	45	22	68	500
CH-CMV1/2G-RO	1/2"	F 1/2"	5006	70,0	39,6X3	50	26	90	450
CH-CMV3/4G-RO	3/4"	F 3/4"	5006	73,0	44,7X3	55	30	170	400
CH-CMV1G-RO	1"	F 1"	5006	82,0	57,6X4	70	40	312	350
CH-CMV1.1/4G-RO	1 1/4"	F 1 1/4"	5006	88,0	65,5X5	80	48	425	320
CH-CMV1.1/2G-RO	1 1/2"	F 1 1/2"	5006	90,0	74,5X5	87	55	625	300
CH-CMV2G-RO	2"	F 2"	5006	120,0	100X5	130	76	1080	250

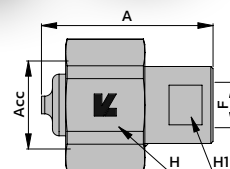
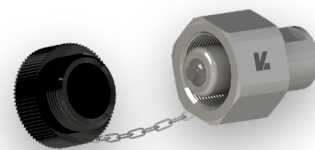

**MATIÈRE**  
Acier - CR3

**JOINT**  
NBR - PTFE

**TEMPÉRATURE DE SERVICE**  
-25 à +125 °C

**ACCESSOIRES POUR COUPLEURS ROFLEX**

Référence	Description	Taille	Pour coupleur	Type	Matière	Couleur
CH-BCFV3/8G-RO	Bouchon	3/8"	Femelle	5005	Plastique	Noir
CH-BCFV1/2G-RO	Bouchon	1/2"	Femelle	5005	Plastique	Noir
CH-BCFV3/4G-RO	Bouchon	3/4"	Femelle	5005	Plastique	Noir
CH-BCFV1G-RO	Bouchon	1"	Femelle	5005	Plastique	Noir
CH-BCFV1.1/4G-RO	Bouchon	1 1/4"	Femelle	5005	Plastique	Noir
CH-BCFV1.1/2G-RO	Bouchon	1 1/2"	Femelle	5105	Plastique	Noir
CH-BCFV2G-RO	Bouchon	2"	Femelle	5005	Plastique	Noir
CH-BCMV3/8G-RO	Bouchon	3/8"	Mâle	5006	Plastique	Noir
CH-BCMV1/2G-RO	Bouchon	1/2"	Mâle	5006	Plastique	Noir
CH-BCMV3/4G-RO	Bouchon	3/4"	Mâle	5006	Plastique	Noir
CH-BCMV1G-RO	Bouchon	1"	Mâle	5006	Plastique	Noir
CH-BCMV1.1/4G-RO	Bouchon	1 1/4"	Mâle	5006	Plastique	Noir
CH-BCMV1.1/2G-RO	Bouchon	1 1/2"	Mâle	5006	Plastique	Noir
CH-BCMV2G-RO	Bouchon	2"	Mâle	5006	Plastique	Noir



**DEMI-VALVES AGRICOLES**

Référence	Corps	F	A	ACC	H	H1	Débit maxi (l/m)	PN (bar)
<b>METRIQUE &gt;&gt;&gt;</b>								
CH-VA8R	1/2"	F 18X150	54,0	36	41	22	48	200
CH-VA12R	3/4"	F 24X150	78,7	-	50	29	-	-

Référence	Corps	F	A	ACC	H	Débit maxi (l/m)	PN (bar)
<b>BSPP &gt;&gt;&gt;</b>							
CH-VA8T1/2	1/2"	M 1/2"	50,5	36	-	48	200
<b>METRIQUE &gt;&gt;&gt;</b>							
CH-VA8T10	1/2"	10L - M16X150 CL	52,0	36	32	48	200
CH-VA8T12	1/2"	12L - M18X150 CL	55,0	36	36	48	200
CH-VA8T	1/2"	13N - M20X150 CL	57,0	36	36	48	200
CH-VA8T15	1/2"	15L - M22X150 CL	57,0	36	36	48	200

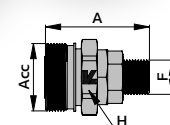
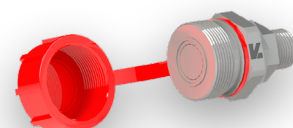
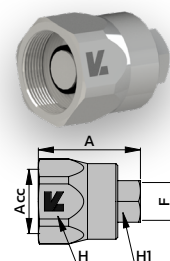

**MATIÈRE**  
Acier - CR3

**JOINT**  
NBR - PTFE

**TEMPÉRATURE DE SERVICE**  
-25 à +125 °C

**ATTENTION**  
Aucune connexion /  
déconnexion sous pression  
permise

**ACCESSOIRES POUR DEMI-VALVES AGRICOLE**

Référence	Description	Taille	Pour demi-valve	Type	Matière	Couleur
CH-BV8R	Bouchon	1/2"	Remorque	AGRICOLE	Acier	Acier
CH-BVA8T	Bouchon	1/2"	Tracteur	AGRICOLE	Plastique	Rouge

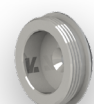

## DEMI-VALVES FREINAGE ISO 5676

Référence	F	A	D	H	Débit maxi (l/m)	PN (bar)
<b>BSPP &gt;&gt;&gt;</b>						
CH-VF8R1/2*	1/2"	56,0	44,0	27	48	150
<b>METRIQUE &gt;&gt;&gt;</b>						
CH-VF8R*	F 18X150	56,0	44,0	27	48	150

\* bouchon acier inclus

Référence	F	A	ACC	H	Débit maxi (l/m)	PN (bar)
<b>METRIQUE &gt;&gt;&gt;</b>						
CH-VF8T12	12L - M18X150 CL	51,0	29,0	32	48	150
CH-VF8T13	13N - M20X150 CL	51,0	29,0	32	48	150

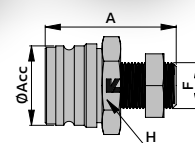
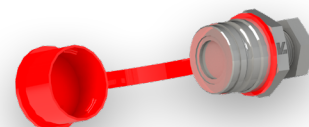
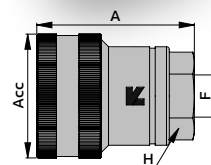

**MATIÈRE**  
Acier - CR3

**JOINT**  
NBR - PTFE

**INTERCHANGEABLE**  
Selon ISO 5676

**ATTENTION**  
Aucune connexion /  
déconnexion sous pression  
permise

## ACCESSOIRES POUR DEMI-VALVES FREINAGE

Référence	Description	Taille	Pour demi-valve	Type	Matière	Couleur
CH-BF8R	Bouchon	1/2"	Remorque	ISO 5676	Acier	Acier
CH-BVF8T	Bouchon	1/2"	Tracteur	ISO 5676	Plastique	Gris



**CPL PASSAGE LIBRE THP**

Référence	Corps	F	A	D	H	Pression (Bar)
<b>CH-CFPL0404HP-ZN</b>	1/4"	F 1/4"	36,0	28,0	19	700
<b>CH-CFPL0606HP-ZN</b>	3/8"	F 3/8"	38,0	34,0	23	600
<b>CH-CFPL0808HP-ZN</b>	1/2"	F 1/2"	45,4	38,0	27	500
<b>CH-CFPL1212HP-ZN</b>	3/4"	F 3/4"	54,0	47,0	35	400

Billes d'accouplement et ressort en inox

Référence	Corps	F	A	ØAcc	H	Pression (Bar)
<b>CH-CMPLO404HP-ZN</b>	1/4"	F 1/4"	25,5	14,2	19	700
<b>CH-CMPLO606HP-ZN</b>	3/8"	F 3/8"	28,0	19,0	23	600
<b>CH-CMPLO808HP-ZN</b>	1/2"	F 1/2"	33,1	20,5	27	500
<b>CH-CMPL1212HP-ZN</b>	3/4"	F 3/4"	40,0	27,9	34	400

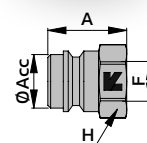
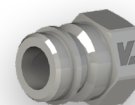
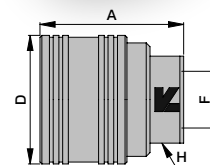
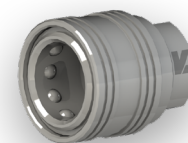

**MATIÈRE**  
Acier - ZN

**JOINT**  
NBR - PTFE

**TEMPÉRATURE DE SERVICE**  
-25 à +125 °C

# COUPLEURS FASTER

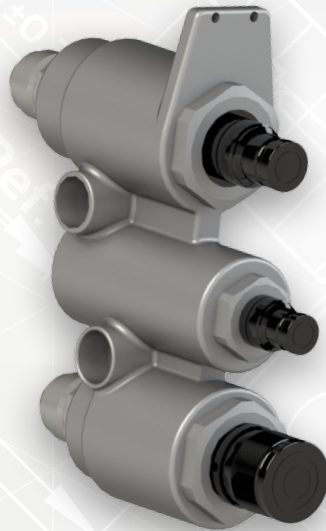
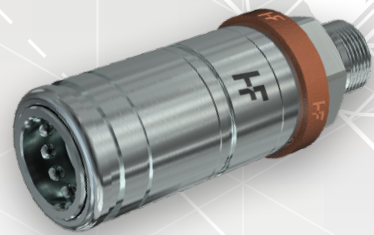
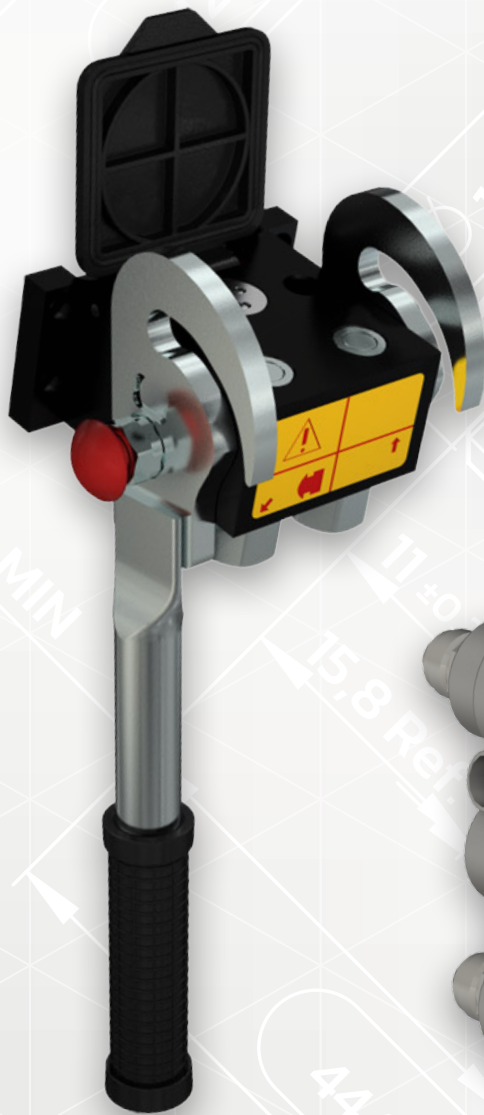

SECTION A-A

**CPL A CLAPET ISO A / ANV**

Référence	Corps	F	A	D	H	Débit maxi (l/m)	PN (bar)
<b>BSPP &gt;&gt;&gt;</b>							
CF-ANV14GASF	1/4"	F 1/4"	47,2	25,0	19	8	500
CF-ANV38GASF	3/8"	F 3/8"	57,0	32,0	22	30	300
CF-NV12GASF	1/2"	F 1/2"	66,0	38,0	27	75	300
CF-ANV34GASF	3/4"	F 3/4"	82,5	48,0	34	180	300
CF-ANV1GASF	1"	F 1"	100,0	56,0	41	270	250
CF-ANV114GASF	1"1/4	F 1"1/4	116,0	70,0	50	330	250
CF-ANV112GASF	1"1/2	F 1"1/2	132,5	84,0	60	450	200
CF-ANV2GASF	2"	F 2"	161,0	100,0	75	900	150

Référence	Corps	F	A	ØAcc	H	Débit maxi (l/m)	PN (bar)
<b>BSPP &gt;&gt;&gt;</b>							
CF-ANV14GASM	1/4"	F 1/4"	38,6	11,8	19	8	500
CF-ANV38GASM	3/8"	F 3/8"	39,0	17,2	22	30	300
CF-NV12GASM	1/2"	F 1/2"	44,0	20,5	27	75	300
CF-ANV34GASM	3/4"	F 3/4"	55,0	29,0	34	180	300
CF-ANV1GASM	1"	F 1"	66,0	34,3	41	270	250
CF-ANV114GASM	1"1/4	F 1"1/4	73,0	44,9	50	330	250
CF-ANV112GASM	1"1/2	F 1"1/2	83,0	55,0	60	450	200
CF-ANV2GASM	2"	F 2"	100,0	65,0	75	900	150

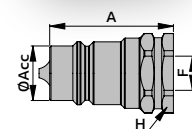
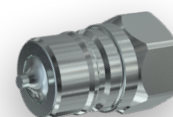
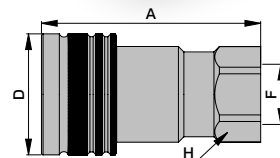
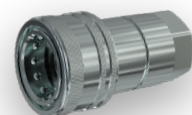

**MATIÈRE**  
Acier - CR3

**JOINT**  
NBR - PTFE

**TEMPÉRATURE DE SERVICE**  
-25 à +125 °C

**INTERCHANGEABLE**  
Selon ISO 7241-A

**CPL PUSH-PULL ISO A / PV & CPV**

Référence	Corps	F	A	D	H	Débit maxi (l/m)	PN (bar)
<b>METRIQUE &gt;&gt;&gt;</b>							
CF-CPV067/1415F	3/8"	08L - M14X150 CL	76,7	33,0	24	24	270
CF-CPV062/1615F	3/8"	10L - M16X150	61,7	33,0	24	24	270
CF-CPV082/1415F	1/2"	08L - M14X150	64,3	38,0	27	75	250
CF-CPV082/1615F	1/2"	10L - M16X150	63,8	38,0	27	75	250
CF-CPV082/1815F	1/2"	12L - M18X150	62,3	38,0	27	75	250
CF-CPV082/2215F	1/2"	15L - M22X150	62,3	38,0	27	75	250
CF-CPV082/2615F	1/2"	18L - M26X150	62,3	38,0	27	75	250
CF-CPV083/2015F	1/2"	12S - M20X150	62,3	38,0	27	75	250
CF-CPV083/2415F	1/2"	16S - M24X150	65,3	38,0	27	75	250
CF-CPV087/1615F	1/2"	10L - M16X150 CL	78,8	38,0	27	75	250
CF-CPV085/1815F	1/2"	12L - M18X150 CL	86,3	38,0	27	75	250
CF-CPV087/1815F	1/2"	12L - M18X150 CL	77,3	38,0	27	75	250
CF-CPV085/2215F	1/2"	15L - M22X150 CL	86,3	38,0	27	75	250
CF-CPV087/2215F	1/2"	15L - M22X150 CL	77,3	38,0	27	75	250
CF-CPV086/2015F	1/2"	12S - M20X150 CL	86,3	40,0	27	75	250
CF-CPV081/2215F	1/2"	M 22X150 - ISO	66,3	38,0	27	75	250

<b>SAE &gt;&gt;&gt;</b>							
CF-CPV081/12SAEF	1/2"	M 3/4" UNF	62,4	38,0	27	75	250
CF-CPV0812/12SAEF	1/2"	M 13/16" ORFS UN CL	85,8	38,0	27	75	250
CF-CPV0814/12SAEF	1/2"	M 3/4" JIC UNF CL	87,9	38,0	27	75	250

Référence	Corps	F	A	D	H	Débit maxi (l/m)	PN (bar)
<b>BSPP &gt;&gt;&gt;</b>							
CF-CPV0838GASF	1/2"	F 3/8"	62,3	38,0	27	75	250
CF-CPV080/38GASF	1/2"	F 3/8" - ISO	62,3	38,0	27	75	250
CF-PV12GASF	1/2"	F 1/2"	66,0	38,0	27	75	250
CF-CPV080/12GASF	1/2"	F 1/2" - ISO	66,3	38,0	27	75	250
CF-CPV161GASF	1"	F 1"	102,3	54,0	42	270	220

<b>METRIQUE &gt;&gt;&gt;</b>							
CF-CPV080/1815F	1/2"	F 18X150 - ISO	62,3	38,0	27	75	250
CF-CPV080/2215F	1/2"	F 22X150 - ISO	66,3	38,0	27	75	250
CF-CPV082215F	1/2"	F 22X150	66,0	38,0	27	75	250
<b>SAE &gt;&gt;&gt;</b>							
CF-CPV080/12SAEF	1/2"	F 3/4" UNF	66,3	38,0	27	75	250
CF-CPV080/58SAEF	1/2"	F 7/8" UNF	62,3	38,0	27	75	250

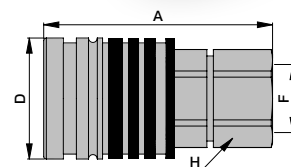
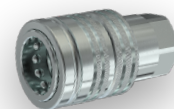
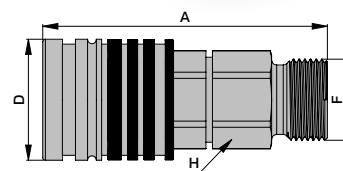
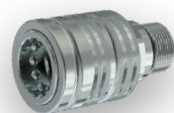

**MATIÈRE**  
Acier - CR3

**JOINT**  
NBR - PTFE

**TEMPÉRATURE DE SERVICE**  
-25 à +125 °C

**INTERCHANGEABLE**  
Selon ISO 7241-A

**CPL PUSH-PULL ISO A / CNV**

Référence	Corps	F	A	ØAcc	H	Débit maxi (l/m)	PN (bar)
<b>BSPP &gt;&gt;&gt;</b>							
CF-CNVO816/38GASM	1/2"	M 3/8" 60°	59,5	20,5	27	75	250
CF-CNVO838GASM	1/2"	F 3/8"	57,0	20,5	27	75	250
CF-CNVO816/12GASM	1/2"	M 1/2" 60°	60,0	20,5	27	75	250
CF-CNVO161GASM	1"	F 1"	77,0	34,3	42	270	220
<b>METRIQUE &gt;&gt;&gt;</b>							
CF-CNVO62/1615M	3/8"	10L - M16X150	54,2	17,2	24	24	270
CF-CNVO82/1415M	1/2"	08L - M14X150	59,0	20,5	27	75	250
CF-CNVO82/1615M	1/2"	10L - M16X150	58,5	20,5	27	75	250
CF-CNVO82/1815M	1/2"	12L - M18X150	57,0	20,5	27	75	250
CF-CNVO80/1815M	1/2"	F 18X150 - ISO	57,0	20,5	27	75	250
CF-CNVO82/2215M	1/2"	15L - M22X150	58,0	20,5	27	75	250
CF-CNVO80/2215M	1/2"	F 22X150 - ISO	61,0	20,5	27	75	250
CF-CNVO82/2615M	1/2"	18L - M26X150	58,0	50,5	27	75	250
CF-CNVO83/2015M	1/2"	12S - M20X150	58,0	20,5	27	75	250
CF-CNVO83/2415M	1/2"	16S - M24X150	60,0	20,5	27	75	250
CF-CNVO87/1615M	1/2"	10L - M16X150 CL	73,5	20,5	27	75	250
CF-CNVO85/1815M	1/2"	12L - M18X150 CL	78,0	20,5	27	75	250
CF-CNVO87/1815M	1/2"	12L - M18X150 CL	72,0	20,5	27	75	250
CF-CNVO85/2215M	1/2"	15L - M22X150 CL	81,0	20,5	27	75	250
CF-CNVO87/2215M	1/2"	15L - M22X150 CL	72,0	20,5	27	75	250
CF-CNVO86/2015M	1/2"	12S - M20X150 CL	81,0	20,5	27	75	250
CF-CNVO162/302M	1"	22L - M30X200	71,5	34,3	38	270	220
<b>SAE &gt;&gt;&gt;</b>							
CF-CNVO814/12SAEM	1/2"	M 3/4" UNF JIC CL	83,0	20,5	27	75	250

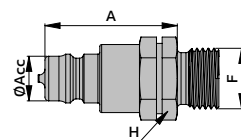
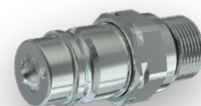

**MATIÈRE**  
Acier - CR3

**JOINT**  
NBR - PTFE

**TEMPÉRATURE DE SERVICE**  
-25 à +125 °C

**DESIGN**  
Pour femelle push-pull CPV

**INTERCHANGEABLE**  
Selon ISO 7241-A

**CPL PUSH-PULL CSP ISO A / 3CFHF & CNVHF**

Référence	Corps	F	A	D	H	Débit maxi (l/m)	PN (bar)
<b>BSPP &gt;&gt;&gt;</b>							
CF-3CFHF0874/38GF	1/2"	M 3/8" 60° CL	108,2	42,0	32	70	250
CF-3CFHF0812GASF	1/2"	F 1/2"	106,2	42,0	27	70	250
<b>METRIQUE &gt;&gt;&gt;</b>							
CF-3CFHF087/1815F	1/2"	12L - M18X150 CL	121,2	42,0	32	70	250
CF-3CFHF087/2215F	1/2"	15L - M22X150 CL	122,4	42,0	32	70	250
CF-3CFHF087/2615F	1/2"	18L - M26X150 CL	125,2	42,0	32	70	250
CF-3CFHF8/2415F	1/2"	16S - M24X150 CL	120,4	42,0	32	70	250
CF-3CFHF081/2215F	1/2"	M 22X150 ISO	109,7	42,0	32	70	250
CF-3CFHF0821/2215F	1/2"	M 22X150 JE	109,2	42,0	32	70	250
<b>SAE &gt;&gt;&gt;</b>							
CF-3CFHF34UNFF	1/2"	F 3/4" UNF	106,2	42,0	27	70	250
CF-3CFHF1/78UNFF	1/2"	M 7/8" UNF	107,4	42,0	32	70	250
CF-3CFHF14/34UNFF	1/2"	M 3/4" UNF JIC - CL	123,7	42,0	32	70	250
CF-3CFHF14/78UFVAL	1/2"	M 3/4" UNF JIC - CL	162,0	42,0	32	70	250
CF-3CFHF14/78UNFF	1/2"	M 7/8" UNF JIC - CL	127,7	42,0	32	70	250
CF-3CFHF12/1UNSF	1/2"	M 1" UNS ORFS - CL	129,2	42,0	32	70	250

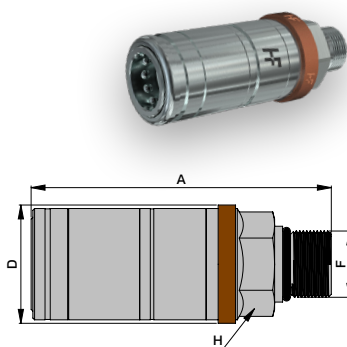

Référence	Corps	F	A	ØAcc	H	Débit maxi (l/m)	PN (bar)
<b>METRIQUE &gt;&gt;&gt;</b>							
CF-CNVHF082/1815M	1/2"	12L - M18X150	57	20,5	27	70	250
CF-CNVHF082/2215M	1/2"	15L - M22X150	58	20,5	27	70	250

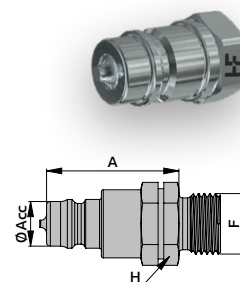

**MATIÈRE**  
Acier - CR3

**JOINT**  
NBR - PTFE

**TEMPÉRATURE DE SERVICE**  
-25 à +125 °C

**FONCTION DE RUPTURE**  
Pas de rupture du flexible en cas de traction involontaire exercée par le tracteur grâce à la déconnexion du mâle

**CONNEXION**  
Connectable sous pression : mâle uniquement

**CPL PUSH-PULL CSP ISO A / 4SRHF**

Référence	Corps	F	A	ØAcc	H	Débit maxi (l/m)	PN (bar)
<b>METRIQUE &gt;&gt;&gt;</b>							
<b>CF-4SRHF081/22F</b>	1/2"	M 22X150 ISO	112,5	42,0	32	70	250
<b>CF-4SRHF087/2215F</b>	1/2"	15L - M22X150 CL	125,2	42,0	32	70	250

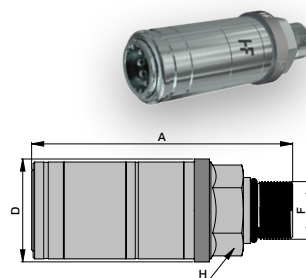

**MATIÈRE**  
Acier - CR3

**JOINT**  
NBR - PTFE

**TEMPÉRATURE DE SERVICE**  
-25 à +125 °C

**FONCTION DE RUPTURE**  
Pas de rupture du flexible en cas de traction involontaire exercée par le tracteur grâce à la déconnexion du mâle

**CONNEXION**  
Connectable sous pression.

**ACCESSOIRES POUR COUPLEURS ISO A**

Référence	Description	Taille	Pour coupleur	Type	Matière	Couleur
<b>CF-TFA14</b>	Bouchon	1/4"	Mâle	ANV	PVC	Jaune
<b>CF-TFA38</b>	Bouchon	3/8"	Mâle	ANV/CNV	PVC	Jaune
<b>CF-TF12G</b>	Bouchon	1/2"	Mâle	ANV/NV/NS/CNV	PVC	Jaune
<b>CF-TFA34</b>	Bouchon	3/4"	Mâle	ANV/CNV	PVC	Jaune
<b>CF-TFA1</b>	Bouchon	1"	Mâle	ANV/CNV	PVC	Jaune
<b>CF-TMA14</b>	Bouchon	1/4"	Femelle	ANV	PVC	Jaune
<b>CF-TMA38</b>	Bouchon	3/8"	Femelle	ANV/CPV	PVC	Jaune
<b>CF-TM12L/G</b>	Bouchon	1/2"	Femelle	ANV/NV/NS/PV/CPV/3CFHF	PVC	Jaune
<b>CF-TMA34</b>	Bouchon	3/4"	Femelle	ANV/CPV	PVC	Jaune
<b>CF-TMA1</b>	Bouchon	1"	Femelle	ANV/CPV	PVC	Jaune

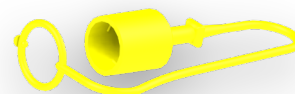

Référence	Description	Taille	Type
<b>CF-SKANV14</b>	Kit joints CPL femelle	1/4"	ANV
<b>CF-SKANV38</b>	Kit joints CPL femelle	3/8"	ANV/CPV
<b>CF-SKNV12</b>	Kit joints CPL femelle	1/2"	NV/ANV/NS/CPV/VV/VVS
<b>CF-SKANV34</b>	Kit joints CPL femelle	3/4"	ANV/CPV
<b>CF-SKANV1</b>	Kit joints CPL femelle	1"	ANV/CPV
<b>CF-SKANV114</b>	Kit joints CPL femelle	1"1/4	ANV
<b>CF-SKANV112</b>	Kit joints CPL femelle	1"1/2	ANV
<b>CF-SKANV2</b>	Kit joints CPL femelle	2"	ANV



**CPL A CLAPET STD / NV**

Référence	Corps	F	A	D	H	Débit maxi (l/m)	PN (bar)
<b>BSPP &gt;&gt;&gt;</b>							
CF-NV14GASF	1/4"	F 1/4"	50,0	27,0	19	15	350
CF-NV38GASF	3/8"	F 3/8"	59,5	33,0	24	50	300
CF-NV12GASF	1/2"	F 1/2"	66,0	38,0	27	75	300
CF-NV34GASF	3/4"	F 3/4"	84,0	48,0	34	150	300
CF-NV1GASF	1"	F 1"	99,5	56,0	41	220	250
CF-NV114GASF	1"1/4	F 1"1/4	82,5	70,2	34	340	220
CF-NV112GASF	1"1/2	F 1"1/2	127,5	84,0	60	450	200
CF-NV2GASF	2"	F 2"	151,0	119,0	75	1000	150

Référence	Corps	F	A	ØAcc	H	Débit maxi (l/m)	PN (bar)
<b>BSPP &gt;&gt;&gt;</b>							
CF-NV14GASM	1/4"	F 1/4"	34,7	14,1	19	15	350
CF-NV38GASM	3/8"	F 3/8"	39,0	18,9	24	50	300
CF-NV12GASM	1/2"	F 1/2"	44,0	20,5	27	75	300
CF-NV34GASM	3/4"	F 3/4"	55,0	27,9	34	150	300
CF-NV1GASM	1"	F 1"	66,0	31,3	41	220	250
CF-NV114GASM	1"1/4	F 1"1/4	73,0	44,0	50	340	220
CF-NV112GASM	1"1/2	F 1"1/2	83,0	53,4	60	450	200
CF-NV2GASM	2"	F 2"	100,0	82,0	75	1000	150

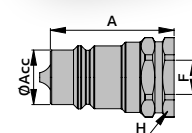
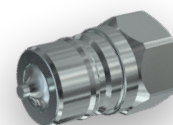
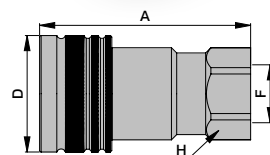
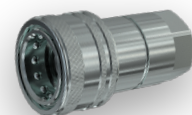

**MATIÈRE**  
Acier - CR3

**JOINT**  
NBR - PTFE

**TEMPÉRATURE DE SERVICE**  
-25 à +125 °C

**INTERCHANGEABLE**  
DN12 interchangeable selon  
ISO 7241-A

**CPL A BILLE STD / NS**

Référence	Corps	F	A	D	H	Débit maxi (l/m)	PN (bar)
<b>BSPP &gt;&gt;&gt;</b>							
CF-NS14GASF	1/4"	F 1/4"	50,0	27,0	19	15	250
CF-NS38GASF	3/8"	F 3/8"	59,5	33,0	24	30	250
CF-NS12GASF	1/2"	F 1/2"	68,0	38,0	27	70	200
CF-NS34GASF	3/4"	F 3/4"	82,5	48,0	34	80	170
CF-NS1GASF	1"	F 1"	96,5	56,0	41	140	220

Référence	Corps	F	A	ØAcc	H	Débit maxi (l/m)	PN (bar)
<b>BSPP &gt;&gt;&gt;</b>							
CF-NS14GASM	1/4"	F 1/4"	34,7	14,1	19	15	250
CF-NS38GASM	3/8"	F 3/8"	39,0	18,9	24	30	250
CF-NS12GASM	1/2"	F 1/2"	46,0	20,5	27	70	200
CF-NS34GASM	3/4"	F 3/4"	53,5	27,9	34	80	170
CF-NS1GASM	1"	F 1"	63,0	31,3	41	140	220

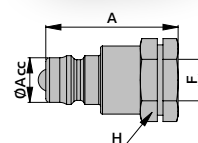
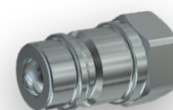
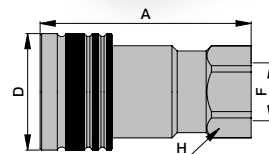
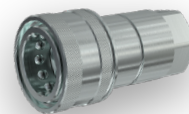

**MATIÈRE**  
Acier - CR3

**JOINT**  
NBR - PTFE

**TEMPÉRATURE DE SERVICE**  
-25 à +125 °C

**INTERCHANGEABLE**  
DN12 interchangeable selon  
ISO 7241-A

**ACCESSOIRES POUR COUPLEURS STD / NV & NS**

Référence	Description	Taille	Pour coupleur	Type	Matière	Couleur
CF-TF14	Bouchon	1/4"	Mâle	NV/NS	PVC	Bleu
CF-TF14S	Bouchon	1/4"	Mâle	NV/NS	Alu	Alu
CF-TF38	Bouchon	3/8"	Mâle	NV/NS	PVC	Bleu
CF-TF38S	Bouchon	3/8"	Mâle	NV/NS	Alu	Alu
CF-TF12	Bouchon	1/2"	Mâle	NV/NS/CNV	PVC	Bleu
CF-TF12S	Bouchon	1/2"	Mâle	NV/NS/CNV	Alu	Alu
CF-TF34	Bouchon	3/4"	Mâle	NV/NS	PVC	Bleu
CF-TF34S	Bouchon	3/4"	Mâle	NV/NS/CNV	Alu	Alu
CF-TF1	Bouchon	1"	Mâle	NV/NS	PVC	Bleu
CF-TF1S	Bouchon	1"	Mâle	NV/NS/CNV	Alu	Alu
CF-TF114S	Bouchon	1"1/4	Mâle	NV	Alu	Alu
CF-TF112S	Bouchon	1"1/2	Mâle	NV	Alu	Alu
CF-TF2S	Bouchon	2"	Mâle	NV	Alu	Alu

CF-TM14	Bouchon	1/4"	Femelle	NV/NS	PVC	Bleu
CF-TM14S	Bouchon	1/4"	Femelle	NV/NS	Alu	Alu
CF-TM38	Bouchon	3/8"	Femelle	NV/NS	PVC	Bleu
CF-TM12L	Bouchon	1/2"	Femelle	NV/NS/PV/CPV/3CFHF	PVC	Bleu
CF-TM12S	Bouchon	1/2"	Femelle	NV/NS/PV/CPV/3CFHF	Alu	Alu
CF-TM34	Bouchon	3/4"	Femelle	NV/NS	PVC	Bleu
CF-TM34S	Bouchon	3/4"	Femelle	NV/NS	Alu	Alu
CF-TM1	Bouchon	1"	Femelle	NV/NS	PVC	Bleu
CF-TM1S	Bouchon	1"	Femelle	NV/NS	Alu	Alu
CF-TM114S	Bouchon	1"1/4	Femelle	NV	Alu	Alu
CF-TM112S	Bouchon	1"1/2	Femelle	NV	Alu	Alu
CF-TM2S	Bouchon	2"	Femelle	NV	Alu	Alu

Référence	Description	Taille	Type
CF-SKNV14	Kit joints CPL femelle	1/4"	NV/NS/VV/VVS
CF-SKNV38	Kit joints CPL femelle	3/8"	NV/NS/VV/VVS
CF-SKNV12	Kit joints CPL femelle	1/2"	NV/ANV/NS/CPV/VV/VVS
CF-SKNV34	Kit joints CPL femelle	3/4"	NV/NS/VV/VVS
CF-SKNV1	Kit joints CPL femelle	1"	NV/NS/VV/VVS
CF-SKNV114	Kit joints CPL femelle	1"1/4	NV
CF-SKNV112	Kit joints CPL femelle	1"1/2	NV
CF-SKNV2	Kit joints CPL femelle	2"	NV

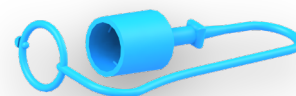

**CPL A CLAPET THP / UHP100**

Référence	Corps	F	A	D	H	Débit maxi (l/m)	PN (bar)
<b>CF-UHP100-14GMSF</b>	1/4"	F1/4" BSPP	63,0	33,0	21	4	1000

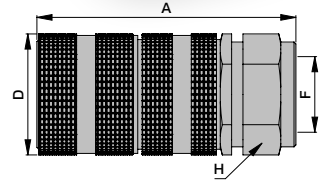
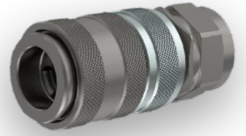

Référence	Corps	F	A	ØAcc	H	Débit maxi (l/m)	PN (bar)
<b>CF-UHP100-14GMSM</b>	1/4"	F1/4" BSPP	34,0	30,0	27	4	1000

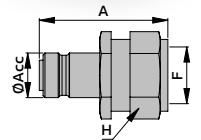

**MATIÈRE**  
Acier - CR3

**JOINT**  
NBR - PTFE

**TEMPÉRATURE DE SERVICE**  
-25 à +125 °C

**CPL A CLAPET ISO B / HNV**

Référence	Corps	F	A	D	H	Débit maxi (l/m)	PN (bar)
<b>BSPP &gt;&gt;&gt;</b>							
CF-HNV18GASF	1/8"	F 1/8"	50,3	23,0	18	5	500
CF-HNV14GASF	1/4"	F 1/4"	56,0	28,0	19	17	450
CF-HNV38GASF	3/8"	F 3/8"	64,0	35,0	24	50	300
CF-HNV12GASF	1/2"	F 1/2"	71,5	44,0	30	75	350
CF-HNV34GASF	3/4"	F 3/4"	89,0	52,0	36	190	250
CF-HNV1GASF	1"	F 1"	106,0	62,0	41	270	300
CF-HNV112GASF	1"1/2	F 1"1/2	126,4	75,0	65	750	140

Référence	Corps	F	A	ØAcc	H	Débit maxi (l/m)	PN (bar)
<b>BSPP &gt;&gt;&gt;</b>							
CF-HNV18GASM	1/8"	F 1/8"	31,5	10,8	17	5	500
CF-HNV14GASM	1/4"	F 1/4"	35,0	14,1	19	17	450
CF-HNV38GASM	3/8"	F 3/8"	39,0	19,0	22	50	300
CF-HNV12GASM	1/2"	F 1/2"	44,0	23,5	27	75	350
CF-HNV34GASM	3/4"	F 3/4"	55,0	31,5	34	190	250
CF-HNV1GASM	1"	F 1"	66,0	37,8	41	270	300
CF-HNV112GASM	1"1/2	F 1"1/2	126,0	44,5	65	750	140

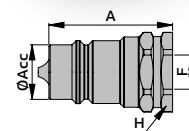
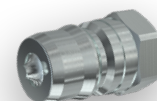
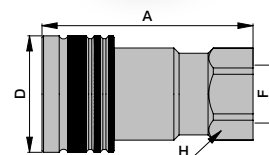
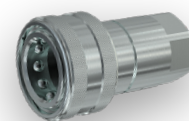

**MATIÈRE**  
Acier - CR3

**JOINT**  
NBR - PTFE

**TEMPÉRATURE DE SERVICE**  
-25 à +125 °C

**INTERCHANGEABLE**  
Selon ISO 7241-B

**ACCESSOIRES POUR COUPLEURS ISO B / HNV**

Référence	Description	Taille	Pour coupleur	Type	Matière	Couleur
<b>CF-TFH18</b>	Bouchon	1/8"	Mâle	HNV	PVC	Rouge
<b>CF-TFH14</b>	Bouchon	1/4"	Mâle	HNV	PVC	Rouge
<b>CF-TFH38</b>	Bouchon	3/8"	Mâle	HNV	PVC	Rouge
<b>CF-TFH12</b>	Bouchon	1/2"	Mâle	HNV	PVC	Rouge
<b>CF-TFH34</b>	Bouchon	3/4"	Mâle	HNV	PVC	Rouge
<b>CF-TFH1</b>	Bouchon	1"	Mâle	HNV	PVC	Rouge



<b>CF-TMH18</b>	Bouchon	1/8"	Femelle	HNV	PVC	Rouge
<b>CF-TMH14</b>	Bouchon	1/4"	Femelle	HNV	PVC	Rouge
<b>CF-TMH38</b>	Bouchon	3/8"	Femelle	HNV	PVC	Rouge
<b>CF-TMH12</b>	Bouchon	1/2"	Femelle	HNV	PVC	Rouge
<b>CF-TMH34</b>	Bouchon	3/4"	Femelle	HNV	PVC	Rouge
<b>CF-TMH1</b>	Bouchon	1"	Femelle	HNV	PVC	Rouge



Référence	Description	Taille	Type
<b>CF-SKHN18</b>	Kit joints CPL femelle	1/8"	HNV
<b>CF-SKHN14</b>	Kit joints CPL femelle	1/4"	HNV
<b>CF-SKHN38</b>	Kit joints CPL femelle	3/8"	HNV
<b>CF-SKNV12</b>	Kit joints CPL femelle	1/2"	HNV
<b>CF-SKHN34</b>	Kit joints CPL femelle	3/4"	HNV
<b>CF-SKHN1</b>	Kit joints CPL femelle	1"	HNV
<b>CF-SKHN112</b>	Kit joints CPL femelle	1 1/2"	HNV



**CPL ANTI-POLLUTION ISO 16028 / FEMELLE FFH**

Référence	Corps	F	A	D	H	Débit maxi (l/m)	PN (bar)
<b>BSPP &gt;&gt;&gt;</b>							
CF-FFH02-18GASF*	1/8"	F 1/8"	46,1	20,0	18	12	350
CF-FFH04-14GASF	1/4"	F 1/4"	58,9	27,0	24	25	350
CF-FFH06-38GASF	3/8"	F 3/8"	75,0	30,0	27	50	350
CF-FFH06-12GASF	3/8"	F 1/2"	79,4	30,0	27	50	350
CF-FFH08-12GASF	1/2"	F 1/2"	81,3	38,0	34	110	350
CF-FFH08-34GASF	1/2"	F 3/4"	84,8	38,0	34	110	350
CF-FFH10-34GASF	5/8"	F 3/4"	92,1	42,0	38	125	350
CF-FFH12-34GASF	3/4"	F 3/4"	100,3	48,0	42	160	350
CF-FFH12-1GASF	3/4"	F 1"	104,3	48,0	42	160	350
CF-FFH16-1GASF	1"	F 1"	100,5	55,0	50	230	350
CF-FFH16-114GASF	1"	F 1"1/4	103,0	55,0	50	230	350
CF-FFH16-112GASF	1"	F 1"1/2	105,3	55,0	55	230	350
<b>NPTF &gt;&gt;&gt;</b>							
CF-FFH04-14NPTF	1/4"	F 1/4"	58,9	27,0	24	25	350
CF-FFH06-38NPTF	3/8"	F 3/8"	75,0	30,0	27	50	350
CF-FFH06-12NPTF	3/8"	F 1/2"	79,4	30,0	27	50	350
CF-FFH08-12NPTF	1/2"	F 1/2"	81,3	38,0	34	110	350
CF-FFH08-34NPTF	1/2"	F 3/4"	81,3	38,0	34	110	350
CF-FFH12-34NPTF	3/4"	F 3/4"	100,3	48,0	42	125	350
CF-FFH16-1NPTF	1"	F 1"	100,5	55,0	50	160	350
<b>UNF &gt;&gt;&gt;</b>							
CF-FFH04-38SAEF	1/4"	F 9/16" UNF	59,6	27,0	24	25	350
CF-FFH06-12SAEF	3/8"	F 3/4" UNF	76,9	30,0	27	50	350
CF-FFH08-12SAEF	1/2"	F 3/4" UNF	81,3	38,0	34	110	350
CF-FFH08-58SAEF	1/2"	F 7/8" UNF	81,3	38,0	34	110	350
CF-FFH08-34SAEF	1/2"	F 1"1/16 UN	86,8	38,0	34	110	350
CF-FFH08-12/58SF	1/2"	M 1" UNS ORFS CL	111,8	38,0	34	110	350
CF-FFH08-12/34SF	1/2"	M 1"3/16 UN ORFS CL	112,8	38,0	36	110	350
CF-FFH08-14/58SF	1/2"	M 7/8" UNF JIC CL	111,4	38,0	34	110	350
CF-FFH08-14/34SF	1/2"	M 1"1/16 UN JIC CL	115,7	38,0	34	110	350
CF-FFH10-34SAEF	5/8"	F 1"1/16 UN	95,1	42,0	38	125	350
CF-FFH12-34SAEF	3/4"	F 1"1/16 UN	104,3	48,0	42	160	350
CF-FFH12-1SAEF	3/4"	F 1"5/16 UN	104,3	48,0	42	160	350
CF-FFH12-12/34SF	3/4"	M 1"3/16 UN ORFS CL	133,4	48,0	42	160	350
CF-FFH12-14/34SF	3/4"	M 1"1/16 UN JIC CL	136,3	48,0	42	160	350
CF-FFH16-1SAEF	1"	F 1"5/16 UN	100,5	55,0	50	230	350
<b>METRIQUE &gt;&gt;&gt;</b>							
CF-FFH06-2/1815F	3/8"	12L - M18X150	80,9	30,0	27	50	350
CF-FFH06-7/1815F	3/8"	12L - M18X150 CL	95,9	30,0	27	50	350
CF-FFH06-2/2215F	3/8"	15L - M22X150	81,9	30,0	30	50	350
CF-FFH06-7/2215F	3/8"	15L - M22X150 CL	97,9	30,0	27	50	350

\*CR3 et pas d'interchangeabilité ISO 16028

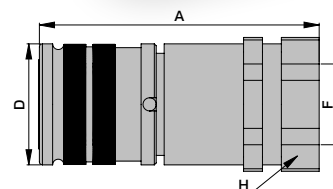
**MATIÈRE**  
Acier - ZN

**JOINT**  
NBR - PUR - PTFE

**TEMPÉRATURE DE SERVICE**  
-25 à +125 °C

**INTERCHANGEABLE**  
Selon ISO 16028

**CPL ANTI-POLLUTION ISO 16028 / MALE FFH**

Référence	Corps	F	A	ØAcc	H	Débit maxi (l/m)	PN (bar)
<b>BSPP &gt;&gt;&gt;</b>							
CF-FFH02-18GASM*	1/8"	F 1/8"	44,0	11,6	16	12	350
CF-FFH04-14GASM	1/4"	F 1/4"	49,0	16,1	24	25	350
CF-FFH06-38GASM	3/8"	F 3/8"	68,3	19,7	30	50	350
CF-FFH06-12GASM	3/8"	F 1/2"	73,3	24,5	30	50	350
CF-FFH08-12GASM	1/2"	F 1/2"	75,0	24,5	34	110	350
CF-FFH08-34GASM	1/2"	F 3/4"	78,0	24,5	34	110	350
CF-FFH10-34GASM	5/8"	F 3/4"	91,1	27,0	41	125	350
CF-FFH12-34GASM	3/4"	F 3/4"	101,6	30,0	42	160	350
CF-FFH12-1GASM	3/4"	F 1"	101,6	30,0	42	160	350
CF-FFH16-1GASM	1"	F 1"	106,5	36,0	55	230	350
CF-FFH16-114GASM	1"	F 1"1/4	109,0	36,0	55	230	350
<b>NPTF &gt;&gt;&gt;</b>							
CF-FFH04-14NPTM	1/4"	F 1/4"	49,0	16,1	24	25	350
CF-FFH06-38NPTM	3/8"	F 3/8"	68,3	19,7	30	50	350
CF-FFH06-12NPTM	3/8"	F 1/2"	71,8	19,7	30	50	350
CF-FFH08-12NPTM	1/2"	F 1/2"	77,0	24,5	34	110	350
CF-FFH08-34NPTM	1/2"	F 3/4"	77,0	24,5	34	110	350
CF-FFH12-34NPTM	3/4"	F 3/4"	101,6	30,0	42	125	350
CF-FFH16-1NPTM	1"	F 1"	107,5	36,0	55	160	350
<b>UNF &gt;&gt;&gt;</b>							
CF-FFH04-38SAEM	1/4"	F 9/16" UNF	52,0	16,1	24	25	350
CF-FFH06-12SAEM	3/8"	F 3/4" UNF	71,8	19,7	30	50	350
CF-FFH08-12SAEM	1/2"	F 3/4" UNF	75,0	24,5	34	110	350
CF-FFH08-58SAEM	1/2"	F 7/8" UNF	76,0	24,5	34	110	350
CF-FFH08-34SAEM	1/2"	F 1"1/16 UN	81,0	24,5	34	110	350
CF-FFH08-12/58SM	1/2"	M 1" UNS ORFS CL	104,0	24,5	34	110	350
CF-FFH08-12/34SM	1/2"	M 1"3/16 UN ORFS CL	105,5	24,5	34	110	350
CF-FFH08-14/58SM	1/2"	M 7/8" UNF JIC CL	103,6	24,5	34	110	350
CF-FFH08-14/34SM	1/2"	M 1"1/16 UN JIC CL	108,4	24,5	34	110	350
CF-FFH10-34SAEM	5/8"	F 1"1/16 UN	94,1	27,0	41	125	350
CF-FFH12-34SAEM	3/4"	F 1"1/16 UN	101,6	30,0	42	160	350
CF-FFH12-1SAEM	3/4"	F 1"5/16 UN	101,6	30,0	42	160	350
CF-FFH12-12/34SM	3/4"	M 1"3/16 UN ORFS CL	127,4	30,0	42	160	350
CF-FFH12-14/34SM	3/4"	M 1"1/16 UN JIC CL	130,3	30,0	42	160	350
CF-FFH16-1SAEM	1"	F 1"5/16 UN	106,5	36,0	55	230	350
<b>METRIQUE &gt;&gt;&gt;</b>							
CF-FFH06-2/1815M	3/8"	12L - M18X150	72,3	19,7	30	50	350
CF-FFH06-7/1815M	3/8"	12L - M18X150 CL	97,3	19,7	30	50	350
CF-FFH06-2/2215M	3/8"	15L - M22X150	73,3	19,7	30	50	350
CF-FFH06-7/2215M	3/8"	15L - M22X150 CL	89,3	19,7	30	50	350

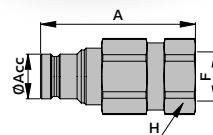
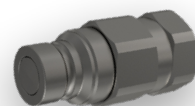

**MATIÈRE**  
Acier - ZN

**JOINT**  
NBR - PUR - PTFE

**TEMPÉRATURE DE SERVICE**  
-25 à +125 °C

**INTERCHANGEABLE**  
Selon ISO 16028

**CPL ANTI-POLLUTION CSP ISO 16028 / 3FFH**

Référence	Corps	F	A	D	H	Débit maxi (l/m)	PN (bar)
<b>BSPP &gt;&gt;&gt;</b>							
CF-3FFH06-38GASF	3/8"	F 3/8"	75,0	30,0	27	35	350
CF-3FFH08-12GASF	1/2"	F 1/2"	81,3	38,0	34	65	350
CF-3FFH12-34GASF	3/4"	F 3/4"	100,0	48,0	42	115	350
<b>SAE &gt;&gt;&gt;</b>							
CF-3FFH08-34SAEF	1/2"	F 1"1/16 UN	87,0	38,0	34	65	350

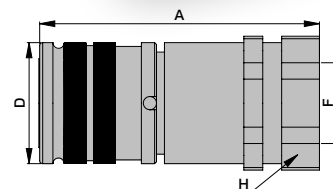

Référence	Corps	F	A	ØAcc	H	Débit maxi (l/m)	PN (bar)
<b>BSPP &gt;&gt;&gt;</b>							
CF-3FFH06-38GASM	3/8"	F 3/8"	96,8	19,7	30	35	350
CF-3FFH06-12GASM	3/8"	F 1/2"	101,8	19,7	30	35	350
CF-3FFH08-12GASM	1/2"	F 1/2"	115,7	24,5	34	65	350
CF-3FFH08-34GASM	1/2"	F 3/4"	118,7	24,5	34	65	350
CF-3FFH12-34GASM	3/4"	F 3/4"	128,4	30,0	42	115	350
CF-3FFH12-1GASM	3/4"	F 1"	128,4	30,0	42	115	350
<b>SAE &gt;&gt;&gt;</b>							
CF-3FFH08-12SAEM	1/2"	F 3/4" UNF	115,7	24,5	34	65	350
CF-3FFH08-34SAEM	1/2"	F 1"1/16 UN	121,7	24,5	34	65	350
CF-3FFH08-12/58SM	1/2"	M 1" UNS ORFS CL	144,7	24,5	34	65	350
CF-3FFH08-12/34SM	1/2"	M 1"3/16 UN ORFS CL	146,2	24,5	34	65	350
CF-3FFH08-14/12SM	1/2"	M 3/4" UNF JIC CL	140,8	24,5	34	65	350
CF-3FFH08-14/58SM	1/2"	M 7/8" UNF JIC CL	144,3	24,5	34	65	350
CF-3FFH08-14/34SM	1/2"	M 1"1/16 UNF JIC CL	149,1	24,5	34	65	350

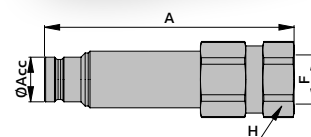
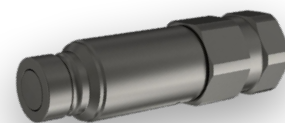

**MATIÈRE**  
Acier - ZN

**JOINT**  
NBR - PUR - PTFE

**TEMPÉRATURE DE SERVICE**  
-25 à +125 °C

**CONNEXION**  
Connectable sous pression.  
Femelle 3FFH connectable sous pression avec mâle FFH.  
Mâle 3FFH connectable sous pression avec femelle FFH.

**INTERCHANGEABLE**  
Selon ISO 16028

**ACCESSOIRES POUR COUPLEURS ANTI-POLLUTION / FFH & 3FFH**

Référence	Description	Taille	Pour coupleur	Type	Matière	Couleur
CF-TF2FI14	Bouchon	1/4"	Mâle	FFH/3FFH	PVC	Orange
CF-TFF38	Bouchon	3/8"	Mâle	FFH/3FFH	PVC	Orange
CF-TF2FI12	Bouchon	1/2"	Mâle	FFH/3FFH	PVC	Orange
CF-TF2FI58	Bouchon	5/8"	Mâle	FFH/3FFH	PVC	Orange
CF-TF2FI34	Bouchon	3/4"	Mâle	FFH/3FFH	PVC	Orange
CF-TF2FI1	Bouchon	1"	Mâle	FFH/3FFH	PVC	Orange



CF-TM2FI14	Bouchon	1/4"	Femelle	FFH/3FFH	PVC	Orange
CF-TMF38	Bouchon	3/8"	Femelle	FFH/3FFH	PVC	Orange
CF-TM2FI12	Bouchon	1/2"	Femelle	FFH/3FFH	PVC	Orange
CF-TM2FI58	Bouchon	5/8"	Femelle	FFH/3FFH	PVC	Orange
CF-TM2FI34	Bouchon	3/4"	Femelle	FFH/3FFH	PVC	Orange
CF-TM2FI1	Bouchon	1"	Femelle	FFH/3FFH	PVC	Orange



Référence	Description	Taille	Pour coupleur	Type	Matière	Couleur
CF-TF2FI14S	Bouchon	1/4"	Mâle	FFH/3FFH	ALU	ALU
CF-TF2FN38S	Bouchon	3/8"	Mâle	FFH/3FFH	ALU	ALU
CF-TF2FI12S	Bouchon	1/2"	Mâle	FFH/3FFH	ALU	ALU
CF-TF2FI58S	Bouchon	5/8"	Mâle	FFH/3FFH	ALU	ALU
CF-TF2FI34S	Bouchon	3/4"	Mâle	FFH/3FFH	ALU	ALU
CF-TF2FI1S	Bouchon	1"	Mâle	FFH/3FFH	ALU	ALU



CF-TM2FI14S	Bouchon	1/4"	Femelle	FFH/3FFH	ALU	ALU
CF-TM2FN38S	Bouchon	3/8"	Femelle	FFH/3FFH	ALU	ALU
CF-TM2FI12S	Bouchon	1/2"	Femelle	FFH/3FFH	ALU	ALU
CF-TM2FI58S	Bouchon	5/8"	Femelle	FFH/3FFH	ALU	ALU
CF-TM2FI34S	Bouchon	3/4"	Femelle	FFH/3FFH	ALU	ALU
CF-TM2FI1S	Bouchon	1"	Femelle	FFH/3FFH	ALU	ALU



Référence	Description	Taille	Type
CF-SKFFH02	Kit joints CPL femelle	1/8"	FFH
CF-SKMF14	Kit joints CPL femelle	1/4"	FFH/MF
CF-SKFFH06	Kit joints CPL femelle	3/8"	FFH
CF-SKFFH08	Kit joints CPL femelle	1/2"	FFH
CF-SKFFH10	Kit joints CPL femelle	5/8"	FFH
CF-SKFFH12	Kit joints CPL femelle	3/4"	FFH
CF-SKFFH16	Kit joints CPL femelle	1"	FFH



**CPL ANTI-POLLUTION A VISSER / FHV**

New réf	Corps	F	A	H1	H2	Débit maxi (l/m)	PN (bar)
<b>BSPP &gt;&gt;&gt;</b>							
CF-FHV06ET-38GASF	3/8"	F 3/8"	101,8	34	45	32	530
CF-FHV08ET-12GASF	1/2"	F 1/2"	109,7	41	52	70	530
CF-FHV08ET-34GASF	1/2"	F 3/4"	109,7	41	52	70	530
CF-FHV12ET-34GASF	3/4"	F 3/4"	129,5	46	60	120	460
CF-FHV12ET-1GASF	3/4"	F 1"	129,5	46	60	120	460
CF-FHV16ET-1GASF	1"	F 1"	138,0	55	70	200	530
CF-FHV16ET-114GASF	1"	F 1"1/4	138,0	55	70	200	530
CF-FHV20ET-114GASF	1"1/4	F 1"1/4	146,7	60	70	350	460
CF-FHV24ET-112GASF	1"1/2	F 1"1/2	146,7	60	70	420	460

New réf	Corps	F	A	ØAcc	H	Débit maxi (l/m)	PN (bar)
<b>BSPP &gt;&gt;&gt;</b>							
CF-FHV06ET-38GASM	3/8"	F 3/8"	96,8	23,0	36	32	530
CF-FHV08ET-12GASM	1/2"	F 1/2"	109,5	31,0	36	70	530
CF-FHV08ET-34GASM	1/2"	F 3/4"	109,5	31,0	36	70	530
CF-FHV12ET-34GASM	3/4"	F 3/4"	122,5	35,0	46	120	460
CF-FHV12ET-1GASM	3/4"	F 1"	124,5	35,0	46	120	460
CF-FHV16ET-1GASM	1"	F 1"	143,8	43,8	55	200	530
CF-FHV16ET-114GASM	1"	F 1"1/4	143,8	43,8	55	200	530
CF-FHV20ET-114GASM	1"1/4	F 1"1/4	165,8	47,8	55	350	460
CF-FHV24ET-112GASM	1"1/2	F 1"1/2	187,1	68,9	75	420	460

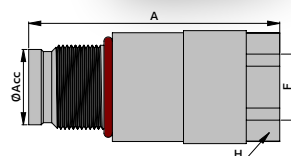
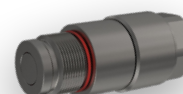
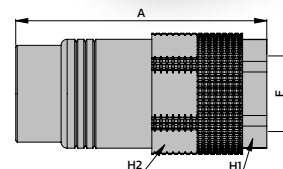

**MATIÈRE**  
Acier - ZN

**JOINT**  
HNBR - PUR - PTFE

**TEMPÉRATURE DE SERVICE**  
-30 à +120 °C

**CONNEXION**  
Connectable sous pression :  
male uniquement.

**ACCESSOIRES POUR COUPLEURS ANTI-POLLUTION A VISSER / FHV**

Référence	Description	Taille	Pour coupleur	Type	Matière	Couleur
CF-TFFHV06S	Bouchon	3/8"	Mâle	FHV	Alu	Alu
CF-TFFHV08S	Bouchon	1/2"	Mâle	FHV	Alu	Alu
CF-TFFHV12S	Bouchon	3/4"	Mâle	FHV	Alu	Alu
CF-TFFHV16S	Bouchon	1"	Mâle	FHV	Alu	Alu
CF-TFFHV24S	Bouchon	1"1/2	Mâle	FHV	Alu	Alu
CF-TFFHV32S	Bouchon	2"	Mâle	FHV	Alu	Alu
CF-TMFHV06S	Bouchon	3/8"	Femelle	FHV	Alu	Alu
CF-TMFHV08S	Bouchon	1/2"	Femelle	FHV	Alu	Alu
CF-TMFHV10S	Bouchon	3/4"	Femelle	FHV	Alu	Alu
CF-TMFHV16S	Bouchon	1"	Femelle	FHV	Alu	Alu
CF-TMFHV24S	Bouchon	1"1/2	Femelle	FHV	Alu	Alu
CF-TMFHV32S	Bouchon	2"	Femelle	FHV	Alu	Alu

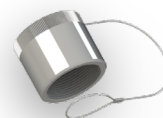

**CPL A VISSER ISO 14541 / FEM CVV**

Référence	Corps	F	A	D	H	Débit maxi (l/m)	PN (bar)
<b>BSPP &gt;&gt;&gt;</b>							
CF-CVV0414GASF	1/4"	F 1/4"	63,0	M24X200	19	13	370
CF-CVV0638GASF	3/8"	F 3/8"	71,0	M28X200	24	25	300
CF-CVV0838GASFV	1/2"	F 3/8"	57,0	M36X200	27	25	300
CF-CVV0812GASFV	1/2"	F 1/2"	61,0	M36X200	27	65	300
CF-CVV1234GASFV	3/4"	F 3/4"	83,0	M42X200	38	100	270
CF-CVV1634GASFV	1"	F 3/4"	89,0	M48X300	38	205	270
CF-CVV1616GASFV	1"	F 1"	94,0	M48X300	42	205	270
CF-CVV24112GASFV	1 1/2"	F 1 1/2"	121,0	M70X300	65	450	270
<b>DIN 24° &gt;&gt;&gt;</b>							
CF-CVV042/1415F	1/4"	O8L - M14X150	58,0	M24X200	19	13	370
CF-CVV047/1415F	1/4"	O8L - M14X150 CL	74,0	M24X200	19	13	370
CF-CVV062/1615F	3/8"	I0L - M16X150	68,0	M28X200	24	25	300
CF-CVV082/1615FV	1/2"	I0L - M16X150	59,0	M36X200	27	65	300
CF-CVV082/1815FV	1/2"	I2L - M18X150	57,0	M36X200	27	65	300
CF-CVV082/2215FV	1/2"	I5L - M22X150	27,0	M36X200	58	65	300
CF-CVV083/2015FV	1/2"	I2S - M20X150	58,0	M36X200	27	65	300
CF-CVV083/2415FV	1/2"	I6S - M24X150	60,0	M36X200	27	65	300
CF-CVV085/1815FV	1/2"	I2L - M18X150 CL	81,0	M36X200	27	65	300
CF-CVV087/1815FV	1/2"	I2L - M18X150 CL	72,0	M36X200	27	65	300
CF-CVV085/2215FV	1/2"	I5L - M22X150 CL	81,0	M36X200	27	65	300
CF-CVV087/2215FV	1/2"	I5L - M22X150 CL	72,0	M36X200	27	65	300
CF-CVV088/2015FV	1/2"	I2S - M20X150 CL	-	M36X200	-	65	300
CF-CVV086/2415FV	1/2"	I6S - M24X150 CL	81,0	M36X200	27	65	300
CF-CVV088/2415FV	1/2"	I6S - M24X150 CL	72,3	M36X200	27	65	300
CF-CVV162/302FV	1"	I22L - M30X200	89,0	M48X300	38	205	270
CF-CVV162/362FV	1"	I28L - M36X200	87,0	M48X300	38	205	270
CF-CVV163/302FV	1"	I20S - M30X200	92,0	M48X300	38	205	270
CF-CVV163/362FV	1"	I25S - M36X200	93,0	M48X300	38	205	270
CF-CVV163/422FV	1"	I30S - M42X200	90,0	M48X300	46	205	270
CF-CVV165/302FV	1"	I22L - M30X200 CL	109,0	M48X300	41	205	270
CF-CVV165/362FV	1"	I28L - M36X200 CL	106,0	M48X300	42	205	270
CF-CVV166/362FV	1"	I25S - M36X200 CL	113,0	M48X300	42	205	270
CF-CVV166/422FV	1"	I30S - M42X200 CL	110,0	M48X300	50	205	270
CF-CVV243/422FV	1 1/2"	I30S - M42X200	115,0	M70X300	55	450	270
CF-CVV243/522FV	1 1/2"	I38S - M52X200	117,0	M70X300	55	450	270
CF-CVV246/422FV	1 1/2"	I30S - M42X200 CL	135,0	M70X300	55	450	270
<b>METRIQUE &gt;&gt;&gt;</b>							
CF-CVV080/2215FV	1/2"	F 22X150 ISO	61,0	M36X200	27	65	300
<b>SAE &gt;&gt;&gt;</b>							
CF-CVV0412/12SF	1/4"	M 13/16" UN ORFS CL	82,5	M24X200	24	13	370
CF-CVV080/12SAEFV	1/2"	F 3/4" UNF	61,0	M36X200	27	65	300
CF-CVV120/34SAEF	3/4"	F 1 1/16 UN	83,0	M42X200	38	100	270

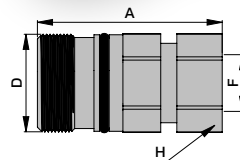
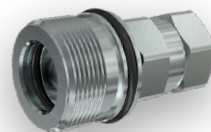

**MATIÈRE**  
Acier - CR3

**JOINT**  
NBR OU FKM - PTFE

**TEMPÉRATURE DE SERVICE**  
NBR : -25 à +125 °C  
FKM : -20 à +200 °C

**CPL A VISSER ISO 14541 / MALE CVV**

Référence	Corps	F	A	D	H	Débit maxi (l/m)	PN (bar)
<b>BSPP &gt;&gt;&gt;</b>							
CF-CVVO414GASM	1/4"	F 1/4"	63,0	30,0	19	13	370
CF-CVVO638GASM	3/8"	F 3/8"	70,0	34,0	24	25	300
CF-CVVO838GASMV	1/2"	F 3/8"	66,0	42,0	27	65	300
CF-CVVO812GASMV	1/2"	F 1/2"	70,0	42,0	27	65	300
CF-CVV1234GASMV	3/4"	F 3/4"	86,0	48,0	38	100	270
CF-CVV1634GASMV	1"	F 3/4"	90,0	56,0	38	205	270
CF-CVV161GASMV	1"	F 1"	95,0	56,0	42	205	270
CF-CVV24112GASMV	1 1/2"	F 1 1/2"	131,0	80,0	65	450	270
<b>DIN 24° &gt;&gt;&gt;</b>							
CF-CVVO42/1415M	1/4"	O8L - M14X150	58,0	30,0	19	13	370
CF-CVVO62/1615M	3/8"	10L - M16X150	66,0	34,0	24	25	300
CF-CVVO82/1615MV	1/2"	10L - M16X150	67,0	42,0	27	65	300
CF-CVVO82/1815MV	1/2"	12L - M18X150	66,0	42,0	27	65	300
CF-CVVO82/2215MV	1/2"	15L - M22X150	67,0	42,0	27	65	300
CF-CVVO83/2015MV	1/2"	12S - M20X150	67,0	42,0	27	65	300
CF-CVVO83/2415MV	1/2"	16S - M24X150	69,0	42,0	27	65	300
CF-CVVO85/1815MV	1/2"	12L - M18X150 CL	90,0	42,0	27	65	300
CF-CVVO87/1815MV	1/2"	12L - M18X150 CL	81,0	42,0	27	65	300
CF-CVVO85/2215MV	1/2"	15L - M22X150 CL	90,0	42,0	27	65	300
CF-CVVO87/2215MV	1/2"	15L - M22X150 CL	81,0	42,0	27	65	300
CF-CVVO88/2015MV	1/2"	12S - M20X150 CL	-	42,0	-	65	300
CF-CVV162/362MV	1"	28L - M36X200	88,0	56,0	38	205	270
CF-CVV163/302MV	1"	20S - M30X200	93,0	56,0	38	205	270
CF-CVV163/362MV	1"	25S - M36X200	93,0	56,0	38	205	270
CF-CVV163/422MV	1"	30S - M42X200	90,0	56,0	38	205	270
CF-CVV165/302MV	1"	22L - M30X200 CL	109,4	56,0	41	205	270
CF-CVV165/362MV	1"	28L - M36X200 CL	107,0	56,0	42	205	270
CF-CVV166/362MV	1"	25S - M36X200 CL	113,0	56,0	42	205	270
CF-CVV166/422MV	1"	30S - M42X200 CL	110,0	56,0	50	205	270
CF-CVV243/422MV	1 1/2"	30S - M42X200	125,0	80,0	55	450	270
CF-CVV243/522MV	1 1/2"	38S - M52X200	127,0	80,0	55	450	270
<b>METRIQUE &gt;&gt;&gt;</b>							
CF-CVVO80/2215MV	1/2"	F 22X150 ISO	70,0	42,0	27	65	300
<b>SAE &gt;&gt;&gt;</b>							
CF-CVVO411/12SM	1/4"	M 13/16" UN ORFS	61,0	30,0	22	13	370
CF-CVVO80/12SAEMV	1/2"	F 3/4" UNF	70,0	42,0	27	65	300
CF-CVV120/34SAEMV	3/4"	F 1 1/16 UN	86,0	48,0	38	100	270

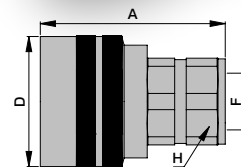

**MATIÈRE**  
Acier - CR3

**JOINT**  
NBR OU FKM - PTFE

**TEMPÉRATURE DE SERVICE**  
NBR : -25 à +125 °C  
FKM : -20 à +200 °C

**ACCESSOIRES POUR COUPLEURS A VISSER / CVV**

Référence	Description	Taille	Pour coupleur	Type	Matière	Couleur
<b>TFVV04</b>	Bouchon	1/4"	Mâle	CVV	PVC	Rouge
<b>TFVV04S</b>	Bouchon	1/4"	Mâle	CVV	Alu	Alu
<b>TFVV06</b>	Bouchon	3/8"	Mâle	CVV	PVC	Rouge
<b>TFVV08</b>	Bouchon	1/2"	Mâle	CVV	PVC	Rouge
<b>TFVV08S</b>	Bouchon	1/2"	Mâle	CVV	Alu	Alu
<b>TFVV12</b>	Bouchon	3/4"	Mâle	CVV	PVC	Rouge
<b>TFVV16</b>	Bouchon	1"	Mâle	CVV	PVC	Rouge
<b>TFVV24</b>	Bouchon	1"1/2	Mâle	CVV	PVC	Rouge

<b>TMVV04</b>	Bouchon	1/4"	Femelle	CVV	PVC	Rouge
<b>TMVV04S</b>	Bouchon	1/4"	Femelle	CVV	Alu	Alu
<b>TMVV06</b>	Bouchon	3/8"	Femelle	CVV	PVC	Rouge
<b>TMVV08</b>	Bouchon	1/2"	Femelle	CVV	PVC	Rouge
<b>TMVV08S</b>	Bouchon	1/2"	Femelle	CVV	Alu	Alu
<b>TMVV12</b>	Bouchon	3/4"	Femelle	CVV	PVC	Rouge
<b>TMVV16</b>	Bouchon	1"	Femelle	CVV	PVC	Rouge
<b>TMVV24</b>	Bouchon	1"1/2	Femelle	CVV	PVC	Rouge

Référence	Description	Taille	Type
<b>CF-SKCVV04</b>	Kit joints CPL femelle	1/4"	CVV
<b>CF-SKCVV06</b>	Kit joints CPL femelle	3/8"	CVV
<b>CF-SKCVV08V</b>	Kit joints CPL femelle	1/2"	CVV
<b>CF-SKCVV12V</b>	Kit joints CPL femelle	3/4"	CVV
<b>CF-SKCVV16V</b>	Kit joints CPL femelle	1"	CVV
<b>CF-SKCVV24V</b>	Kit joints CPL femelle	1"1/2	CVV



**CPL A VISSER DOUBLE FONCTION / VV**

Référence	Corps	F	A	H1	H2	Débit maxi (l/m)	PN (bar)
<b>BSPP &gt;&gt;&gt;</b>							
CF-VV14GASF	1/4"	F 1/4"	60,0	19	27	18	350
CF-VV38GASF	3/8"	F 3/8"	72,0	24	34	30	300
CF-VV12GASF	1/2"	F 1/2"	79,0	27	38	65	250
CF-VV34GASF	3/4"	F 3/4"	106,0	34	50	100	250
CF-VV1GASF	1"	F 1"	124,0	41	55	140	220
<b>NPTF &gt;&gt;&gt;</b>							
CF-VV14NPTF	1/4"	F 1/4"	60,0	19	27	18	350
CF-VV38NPTF	3/8"	F 3/8"	72,0	24	34	30	300
CF-VV12NPTF	1/2"	F 1/2"	79,0	27	38	65	250
CF-VV34NPTF	3/4"	F 3/4"	106,0	34	50	100	250
CF-VV1NPTF	1"	F 1"	124,0	41	55	140	220

Référence	Corps	F	A	ØAcc	H	Débit maxi (l/m)	PN (bar)
<b>BSPP &gt;&gt;&gt;</b>							
CF-VV14GASM	1/4"	F 1/4"	34,7	14,1	19	18	350
CF-VV38GASM	3/8"	F 3/8"	40,5	18,9	24	30	300
CF-VV12GASM	1/2"	F 1/2"	49,0	20,5	27	65	250
CF-VV34GASM	3/4"	F 3/4"	62,0	27,9	34	100	250
CF-VV1GASM	1"	F 1"	73,0	31,8	41	140	220
<b>NPTF &gt;&gt;&gt;</b>							
CF-VV14NPTM	1/4"	F 1/4"	33,0	14,1	19	18	350
CF-VV38NPTM	3/8"	F 3/8"	40,5	18,9	24	30	300
CF-VV12NPTM	1/2"	F 1/2"	49,0	20,5	27	65	250
CF-VV34NPTM	3/4"	F 3/4"	62,0	27,9	34	100	250
CF-VV1NPTM	1"	F 1"	73,0	31,8	41	140	220

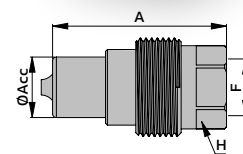
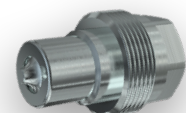
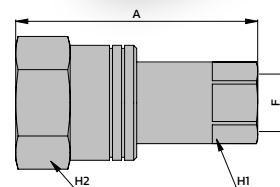
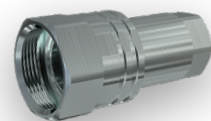

**MATIÈRE**  
Acier - CR3

**JOINT**  
NBR - PTFE

**TEMPÉRATURE DE SERVICE**  
-25 à +125 °C

**BAGUE DE VERROUILLAGE**  
À double fonction

**CONNEXION**  
Femelle VV connectable avec male NV.  
Connectable sous pression résiduelle.

**CPL A VISSER THP / VVS**

Référence	Corps	F	A	D	H	Débit maxi (l/m)	PN (bar)
<b>BSPP &gt;&gt;&gt;</b>							
CF-VVS14GASF	1/4"	F 1/4"	68,0	30,0	22	8	800
CF-VVS38GASF	3/8"	F 3/8"	76,0	40,0	30	18	800
CF-VVS12GASF	1/2"	F 1/2"	87,0	45,0	34	40	700
CF-VVS34GASF	3/4"	F 3/4"	106,0	55,0	41	55	700
CF-VVS1GASF	1"	F 1"	124,0	60,0	50	100	630
CF-VVS114GASF	1"1/4	F 1"1/4	152,0	80,0	65	140	600
CF-VVS112GASF	1"1/2	F 1"1/2	172,0	98,0	72	300	400
CF-VVS2GASF	2"	F 2"	206,0	129,0	100	1000	350

Référence	Corps	F	A	ØAcc	H	Débit maxi (l/m)	PN (bar)
<b>BSPP &gt;&gt;&gt;</b>							
CF-VVS14GASM	1/4"	F 1/4"	43,0	14,1	25	8	800
CF-VVS38GASM	3/8"	F 3/8"	48,0	18,9	30	18	800
CF-VVS12GASM	1/2"	F 1/2"	53,0	20,5	34	40	700
CF-VVS34GASM	3/4"	F 3/4"	63,0	27,9	46	55	700
CF-VVS1GASM	1"	F 1"	72,0	31,3	50	100	630
CF-VVS114GASM	1"1/4	F 1"1/4	86,0	43,9	65	140	600
CF-VVS112GASM	1"1/2	F 1"1/2	95,0	53,4	80	300	400
CF-VVS2GASM	2"	F 2"	118,0	81,9	110	1000	350

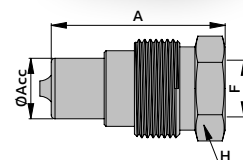
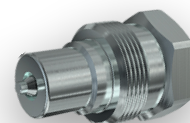
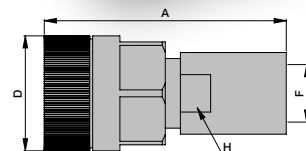
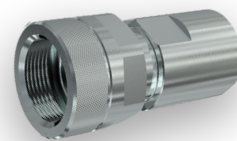

**MATIÈRE**  
Acier - CR3

**JOINT**  
NBR - PTFE

**TEMPÉRATURE DE SERVICE**  
-25 à +125 °C

**INTERCHANGEABLE**  
Avec la série VV

**ACCESSOIRES POUR COUPLEURS A VISSER / VV & VVS**

Référence	Description	Taille	Pour coupleur	Type	Matière	Couleur
CF-TFV14S	Bouchon	1/4"	Mâle	VV/VVS	Alu	Alu
CF-TFV38S	Bouchon	3/8"	Mâle	VV/VVS	Alu	Alu
CF-TFV12S	Bouchon	1/2"	Mâle	VV/VVS	Alu	Alu
CF-TFV34S	Bouchon	3/4"	Mâle	VV/VVS	Alu	Alu
CF-TFV1S	Bouchon	1"	Mâle	VV/VVS	Alu	Alu
CF-TFV114S	Bouchon	1"1/4	Mâle	VV/VVS	Alu	Alu
CF-TFV112S	Bouchon	1"1/2	Mâle	VV/VVS	Alu	Alu
CF-TFV2S	Bouchon	2"	Mâle	VV/VVS	Alu	Alu



CF-TMV14S	Bouchon	1/4"	Femelle	VV/VVS	Alu	Alu
CF-TMV38S	Bouchon	3/8"	Femelle	VV/VVS	Alu	Alu
CF-TMV12S	Bouchon	1/2"	Femelle	VV/VVS	Alu	Alu
CF-TMV34S	Bouchon	3/4"	Femelle	VV/VVS	Alu	Alu
CF-TMV1S	Bouchon	1"	Femelle	VV/VVS	Alu	Alu
CF-TMV114S	Bouchon	1"1/4	Femelle	VV/VVS	Alu	Alu
CF-TMV112S	Bouchon	1"1/2	Femelle	VV/VVS	Alu	Alu
CF-TMV2S	Bouchon	2"	Femelle	VV/VVS	Alu	Alu



Référence	Description	Taille	Type
CF-SKNV14	Kit joints CPL femelle	1/4"	NV/NS/VV/VVS
CF-SKNV38	Kit joints CPL femelle	3/8"	NV/NS/VV/VVS
CF-SKNV12	Kit joints CPL femelle	1/2"	ANV/NV/NS/CPV/VV/VVS
CF-SKNV34	Kit joints CPL femelle	3/4"	NV/NS/VV/VVS
CF-SKNV1	Kit joints CPL femelle	1"	NV/NS/VV/VVS
CF-SKVVS114	Kit joints CPL femelle	1"1/4	VVS
CF-SKVVS112	Kit joints CPL femelle	1"1/2	VVS
CF-SKVVS2	Kit joints CPL femelle	2"	VVS



**CPL A VISSER VERIN ISO 14540 / PVVM**

Référence	Corps	F	A	D	H	Débit maxi (l/m)	PN (bar)
CF-PVVM1/14NPTF	1/4"	M 1/4" NPTF	63,0	33,0	21	15	1030
CF-PVVM1/38NPTF	3/8"	M 3/8" NPTF	83,0	36,0	25	20	1000

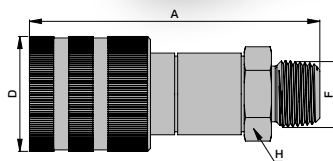
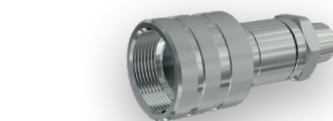

Référence	Corps	F	A	ØAcc	H	Débit maxi (l/m)	PN (bar)
CF-PVVM14NPTM	1/4"	F 1/4" NPTF	34,0	30,0	27	15	1030
CF-PVVM38NPTM	3/8"	F 3/8" NPTF	39,0	35,0	32	20	1000

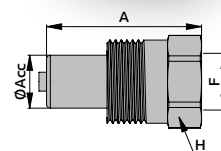
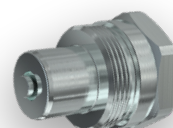

**MATIÈRE**  
Acier - CR3

**JOINT**  
NBR - PTFE

**TEMPÉRATURE DE SERVICE**  
-25 à +125 °C

**INTERCHANGEABLE**  
ISO 14540

**CONNEXION**  
Connectable sous pression résiduelle

**ACCESSOIRES POUR COUPLEURS A VISSER / PVVM**

Référence	Description	Taille	Pour coupleur	Type	Matière	Couleur
CF-TFP14	Bouchon	1/4"	Mâle	PVVM	Alu	Alu
CF-TFP38	Bouchon	3/8"	Mâle	PVVM	Alu	Alu
CF-TMP14	Bouchon	1/4"	Femelle	PVVM	Alu	Alu
CF-TMP38	Bouchon	3/8"	Femelle	PVVM	Alu	Alu

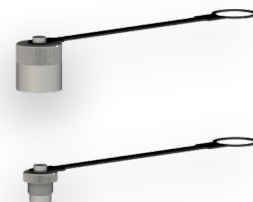

Référence	Description	Taille	Type
CF-SKPVVM14	Kit joints CPL femelle	1/4"	PVVM
CF-SKPVVM38	Kit joints CPL femelle	3/8"	PVVM



## CPL A VISSER CATER / CVC

Référence	Corps	F	A	D	H	Débit maxi (l/m)	PN (bar)
<b>BSPP &gt;&gt;&gt;</b>							
CF-CVC0812GASF	1/2"	F 1/2"	60,0	35	27	50	340
<b>METRIQUE &gt;&gt;&gt;</b>							
CF-CVC080/2215F	1/2"	F 22X150 ISO	60,0	35	27	50	340
CF-CVC082/1815F	1/2"	12L - M18X150	56,0	35	27	50	340
CF-CVC163015F	1"	F 30X150	97,0	54	42	160	340
CF-CVC163/362F	1"	25S - M36X200	98,0	54	38	160	340
<b>SAE &gt;&gt;&gt;</b>							
CF-CVC0858SF	1/2"	F 7/8" UNF	62,0	35	30	50	340
CF-CVC0811/12SF	1/2"	M 13/16" UN ORFS	58,0	35	27	50	340
CF-CVC1678SF	1"	F 1"3/16 UN	97,0	54	42	160	340
<b>BRIDE SAE &gt;&gt;&gt;</b>							
CF-CVC1634/12F	1"	SAE 6000PSI 3/4"	96	54	42	160	340

Référence	Corps	F	A	H1	H2	Débit maxi (l/m)	PN (bar)
<b>BSPP &gt;&gt;&gt;</b>							
CF-CVC0812GASM	1/2"	F 1/2"	48,0	30	41	50	340
<b>METRIQUE &gt;&gt;&gt;</b>							
CF-CVC080/2215M	1/2"	F22X150 ISO	61,0	27	41	50	340
CF-CVC082/2215M	1/2"	15L - M22X150	58,0	27	41	50	340
CF-CVC163015M	1"	F30X150	90,0	42	65	160	340
CF-CVC163/362M	1"	25S - M36X200	91,0	38	65	160	340
CF-CVC163/422M	1"	30S - M42X200	88,0	46	65	160	340
<b>SAE &gt;&gt;&gt;</b>							
CF-CVC081/125M	1/2"	M 3/4" UNF	57,0	27	41	50	340
CF-CVC0858SM	1/2"	F 7/8" UNF	63,0	30	41	50	340
CF-CVC0812/125M	1/2"	M 13/16" UN ORFS CL	80,0	27	41	50	340
CF-CVC0812/585M	1/2"	M 1" UNS ORFS CL	91,0	34	41	50	340
CF-CVC1678SM	1"	F 1"3/16 UN	90,0	42	65	160	340
CF-CVC1615AEM	1"	F 1"5/16 UN	91,0	42	65	160	340
<b>BRIDE SAE &gt;&gt;&gt;</b>							
CF-CVC1634/12M	1"	SAE 6000PSI 3/4"	89,0	-	65	160	340

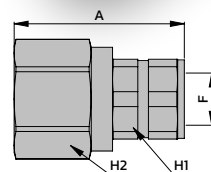
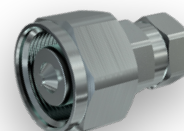
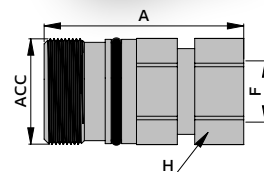
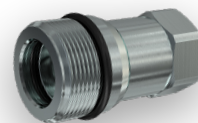

**MATIÈRE**  
Acier - CR3

**JOINT**  
NBR - PTFE

**TEMPÉRATURE DE SERVICE**  
-25 à +125 °C

**DESIGN**  
Résistant aux vibrations et impulsions

**CONNEXION**  
Connectable sous pression résiduelle

## ACCESSOIRES POUR COUPLEURS CATER / CVC

Référence	Description	Taille	Pour coupleur	Type	Matière	Couleur
CF-TFCVC08S	Bouchon	1/2"	Mâle	CVC	Alu	Alu
CF-TFCVC16S	Bouchon	1"	Mâle	CVC	Alu	Alu
CF-TMCVC08S	Bouchon	1/2"	Femelle	CVC	Alu	Alu
CF-TMCVC16S	Bouchon	1"	Femelle	CVC	Alu	Alu

Référence	Description	Taille	Type
CF-SKVC08	Kit joints CPL femelle	1/2"	CVC
CF-SKVC16	Kit joints CPL femelle	1"	CVC



## CPL A VISSER CAMION / CVE

Référence	Corps	F	A	D	H	Débit maxi (l/m)	PN (bar)
CF-CVE34GASF	3/4"	F 3/4" BSPP	84,0	100,0	34	120	360
CF-CVE1GASF	1"	F 1" BSPP	94,4	127,0	41	160	300

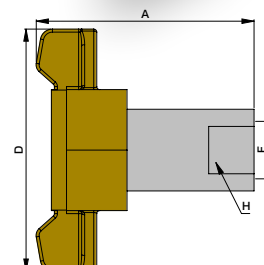
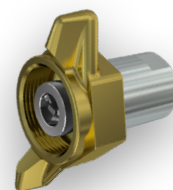

Référence	Corps	F	A	D	H	Débit maxi (l/m)	PN (bar)
CF-CVE34GASM	3/4"	F 3/4" BSPP	78,0	44	50	120	360
CF-CVE1GASM	1"	F 1" BSPP	85,0	54	50	160	300

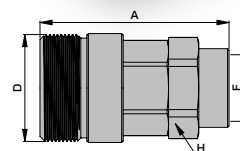

**MATIÈRE**  
Acier - CR3

**JOINT**  
NBR - PTFE

**TEMPÉRATURE DE SERVICE**  
-25 à +125 °C

**CONNEXION**  
Connectable sous pression résiduelle

**INDUSTRIE**  
Transport

## ACCESSOIRES POUR COUPLEURS CAMION / CVE

Référence	Description	Taille	Pour coupleur	Type	Matière	Couleur
CF-TFCVE34S	Bouchon	3/4"	Mâle	CVE	Alu	Alu
CF-TFCVE1S	Bouchon	1"	Mâle	CVE	Alu	Alu
CF-TMCVE34S	Bouchon	3/4"	Femelle	CVE	Alu	Alu
CF-TMCVE1S	Bouchon	1"	Femelle	CVE	Alu	Alu

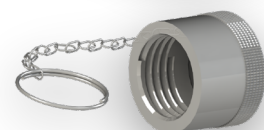

## DEMI-VALVES FREINAGE ISO 5676 / VF

Référence	F	A	D	H	Pour côté	Débit maxi (l/m)	PN (bar)
<b>BSPP &gt;&gt;&gt;</b>							
CF-VF38GASF	F 3/8"	55,0	44,0	27	Remorque	40	150
CF-VF0/12GASF	F 1/2"	59,0	44,0	27	Remorque	40	150
<b>METRIQUE &gt;&gt;&gt;</b>							
CF-VF1815F	F 18X150	55,0	44,0	27	Remorque	40	150

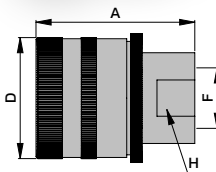
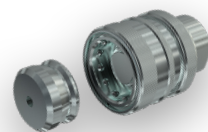

Référence	F	A	ØAcc	H	Pour côté	Débit maxi (l/m)	PN (bar)
<b>BSPP &gt;&gt;&gt;</b>							
CF-VF1/12GASM	M 1/2"	59,0	30,0	32	Tracteur	40	150
<b>METRIQUE &gt;&gt;&gt;</b>							
CF-VF9/1615M	10L - M16X150	54,0	30,0	32	Tracteur	40	150
CF-VF9/1815M	12L - M18X150	54,0	30,0	32	Tracteur	40	150
CF-VF7/1815M	12L - M18X150 CL	53,0	30,0	32	Tracteur	40	150
CF-VF5/2215M	15L - M22X150 CL	59,0	30,0	32	Tracteur	40	150
CF-VF8/2015M	12S - M20X150 CL	54,0	30,0	32	Tracteur	40	150

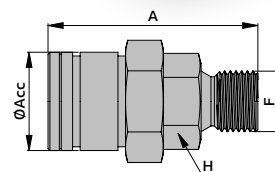
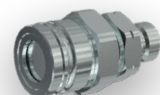

**MATIÈRE**  
Acier - CR3

**JOINT**  
NBR - PTFE

**TEMPÉRATURE DE SERVICE**  
-25 à +125 °C

**INTERCHANGEABLE**  
Selon ISO 5676

**ATTENTION**  
Aucune connexion / déconnexion sous pression permise

## ACCESSOIRES POUR DEMI-VALVES FREINAGE / VF

Référence	Description	Type	Matière	Couleur
CF-TFVF	Bouchon	VF/VFB	PVC	Vert



**CPL FACE PLANE DIAGNOSTIQUE ISO 15171-1 / DF**

Référence	Corps	F	A	D	H	Débit maxi (l/m)	PN (bar)
<b>BSPP &gt;&gt;&gt;</b>							
CF-DF04-14GASF	1/4"	F 1/4"	52,5	24,0	21	2	470
<b>NPTF &gt;&gt;&gt;</b>							
CF-DF04-18NPTF	1/4"	F 1/8"	42,0	24,0	21	2	470
CF-DF04-14NPTF	1/4"	F 1/4"	50,0	24,0	21	2	470
CF-DF04-1/14NPTF	1/4"	M 1/4"	56,0	24,0	21	2	470
<b>SAE &gt;&gt;&gt;</b>							
CF-DF04-14SAEF	1/4"	F 7/16" UNF	54,0	24,0	21	2	470
CF-DF04-38SAEF	1/4"	F 9/16" UNF	54,0	24,0	21	2	470
<b>METRIQUE &gt;&gt;&gt;</b>							
CF-DF04-0/1415F	1/4"	F 14X150 ISO	51,5	24,0	21	2	470

Référence	Corps	F	A	ØAcc	H	Débit maxi (l/m)	PN (bar)
<b>NPTF &gt;&gt;&gt;</b>							
CF-DF04-18NPTM	1/4"	F 1/8"	36,1	12,6	19	2	470
CF-DF04-14NPTM	1/4"	F 1/4"	40,0	12,6	19	2	470
CF-DF04-1/18NPTM	1/4"	M 1/8"	40,9	12,6	17	2	470
CF-DF04-1/14NPTM	1/4"	M 1/4"	41,1	12,6	19	2	470
<b>SAE &gt;&gt;&gt;</b>							
CF-DF04-14SAEM	1/4"	F 7/16" UNF	42,0	12,6	19	2	470
CF-DF04-1/14SAEM	1/4"	M 7/16" UNF	40,5	12,6	17	2	470
CF-DF04-1/38SAEM	1/4"	M 9/16" UNF	37,1	12,6	17	2	470
CF-DF04-27/14SAEM	1/4"	F 7/16" UNF ORFS	40,6	12,6	17	2	470
CF-DF04-28/38SAEM	1/4"	F 9/16" UNF JIC	38,1	12,6	19	2	470
<b>METRIQUE &gt;&gt;&gt;</b>							
CF-DF04-1/1415MB	1/4"	M 14X150 ISO	40,6	12,6	19	2	470

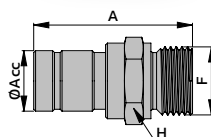
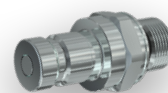
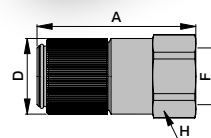
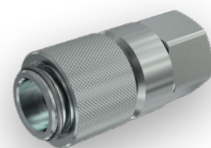

**MATIÈRE**  
Acier - CR3

**JOINT**  
NBR - PTFE

**TEMPÉRATURE DE SERVICE**  
-25 à +125 °C

**INTERCHANGEABLE**  
Selon ISO 15171-1

**ACCESSOIRES POUR COUPLEURS DIAGNOSTIQUE / DF**

Référence	Description	Taille	Pour coupleur	Type	Matière	Couleur
CF-TDF04	Bouchon	1/4"	Mâle	DF	PVC	Noir



## PLATINE 3 COUPLEURS ISO 16028 / 4BD4FH

Référence	Corps	F1	F2	A	Débit maxi (l/m)	PN (bar)
<b>SAE &gt;&gt;&gt;</b>						
CF-4BD4FH08-11/12S	1/2"	M 13/16" UN ORFS	F 9/16" UNF	178,7	100	350
CF-4BD4FH08-11/34S	1/2"	M 1"3/16 UN ORFS	F 9/16" UNF	182,7	100	350
CF-4BD4FH08-13/34S	1/2"	M 1"1/16 UN JIC	F 9/16" UNF	187,6	100	350
CF-4BD4FH12-11/34S	3/4"	M 1"3/16 UN ORFS	F 9/16" UNF	202,5	145	350
CF-4BD4FH12-13/34S	3/4"	M 1"1/16 UN JIC	F 9/16" UNF	207,4	145	350
<b>METRIQUE &gt;&gt;&gt;</b>						
CF-4BD4FH08-3/241S	1/2"	16S - M24X150	10S - M18X150	180,0	100	350

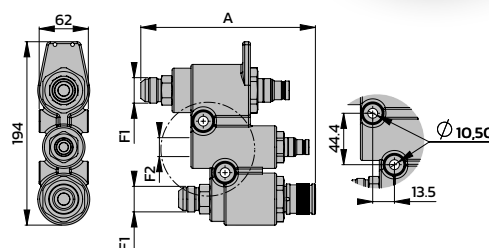
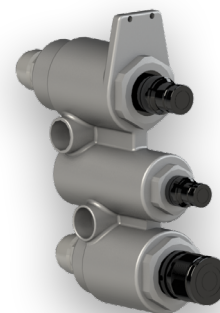

**MATIÈRE**  
Acier - ZN - CR3

**JOINT**  
NBR - PUR - PTFE

**TEMPÉRATURE DE SERVICE**  
-25 à +100 °C

**INTERCHANGEABLE**  
Selon ISO 16028

**CONNEXION**  
Connectable sous pression

## ACCESSOIRES POUR PLATINE 4BD4FH

Référence	Description	Type	Taille	Pour platine
CF-KIT4BD-FFH06M	Kit coupleur	Mâle	3/8"	4BD4FH
CF-KIT4FH08M	Kit coupleur	Mâle	1/2"	4BD4FH08
CF-KIT4FH08F	Kit coupleur	Femelle	1/2"	4BD4FH08
CF-KIT4FH12M	Kit coupleur	Mâle	3/4"	4BD4FH12
CF-KIT4FH12F	Kit coupleur	Femelle	3/4"	4BD4FH12

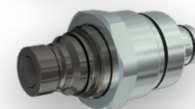
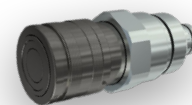

Référence	Description	F
CF-KIT4BD-13/58S	Kit adaptateur	M 7/8" UNF JIC
CF-KIT4BD-13/34S	Kit adaptateur	M 1"1/16 UN JIC

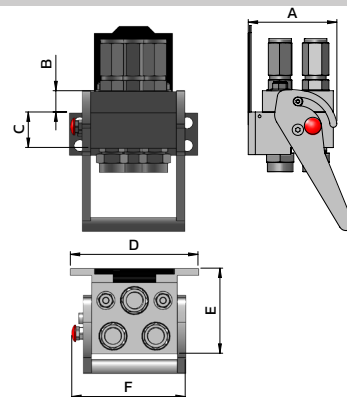
**PLATINE MULTI-FASTER**

SERIE	PB06	P206	P208	P306
<b>3D model</b>				
<b>Nb d'emplacements</b>	2	2	2	3
<b>Combinaisons principales</b>	2 coupleurs	2 coupleurs	2 coupleurs	2 coupleurs OU 2 coupleurs + 1 fiche électrique
<b>Tailles des coupleurs</b>	<b>DASH</b>	6	6	2 X 6 1 X 8
	<b>mm</b>	10	10	2 X 10 1 X 12
	<b>inch</b>	3/8"	3/8"	2 X 3/8" 1 X 1/2" (ou fiche électrique)
<b>Code couleur</b>				
<b>PN (bar)</b>	250	250	250	250
<b>Débit (L/m)</b>	40	40	70	40 70
<b>Applications principales</b>	Agricole (chargeurs frontaux et outils pilotés) ■ BTP ■ Manutention	Agricole ■ BTP ■ Manutention / levage	Agricole ■ BTP ■ Camions bennes Spécialement étudiée pour relier un groupe au circuit hydraulique des camions bennes équipés de compacteur à déchets.	Agricole ■ BTP ■ Manutention ■ Industrie
<b>Accouplement sous pression autorisé</b>	OUI (SERIE 3PB06)	OUI (SERIE 3P206)	OUI (SERIE 3P208)	OUI (SERIE 3P306)
<b>Dimensions (mm)</b>	<b>A</b>	141,0	127,0	124,0
	<b>B</b>	22,0	22,0	30,0
	<b>C</b>	51,3	51,3	60,2
	<b>D</b>	38,0	120,0	120,0
	<b>E</b>	160,0	110,0	110,0
	<b>F</b>	-	127,5	149,0

**PLATINE MULTI-FASTER**

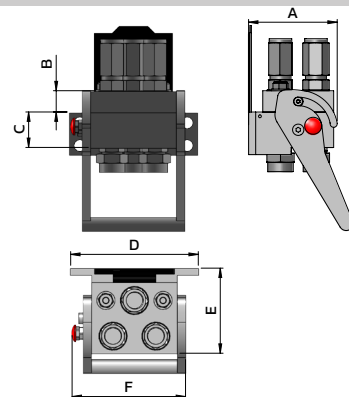

SERIE	P506	P508	P510	PS06	
<b>3D model</b>					
<b>Nb d'emplacements</b>	4	4	4	4	
<b>Combinaisons principales</b>	4 ou 3 coupleurs	4, 3 ou 2 coupleurs OU 3 coupleurs + 1 fiche électrique OU 2 coupleurs + 2 fiches électriques OU 2 coupleurs + 1 fiche électrique	4, 3 ou 2 coupleurs OU 3 coupleurs + 1 fiche électrique OU 2 coupleurs + 2 fiches électriques OU 2 coupleurs + 1 fiche électrique	4 ou 2 coupleurs	
<b>Tailles des coupleurs</b>	<b>DASH</b>	6	8	6	
	<b>mm</b>	10	12	10	
	<b>inch</b>	3/8"	1/2" (ou fiche électrique)	2 X 1/2" (ou fiche électrique) 2 X 3/4"	3/8"
<b>Code couleur</b>					
<b>PN (bar)</b>	250	250	250	250	
<b>Débit (L/m)</b>	40	70	70 105	40	
<b>Applications principales</b>	Agricole ■ BTP ■ Manutention ■ Entretien routier (balayeuse, chasse-neige, etc.)	Agricole ■ BTP ■ Manutention Platine polyvalente (chariot élevateur, chargeuse à pneu, convoyeur, carrière, voirie, maintenance ferroviaire, etc.)	BTP ■ Industrie ■ Mines et plateformes pétrolières Utilisée communément dans le BTP et chez les tunneliers sur les chargeuses (dumper), pelles équipées de rouleau compresseur et raboteuse de chaussées.	Agricole (chargeurs et outils frontaux) ■ Plasturgie	
<b>Accouplement sous pression autorisé</b>	OUI (SERIE 3P506)	OUI (SERIE 3P508)	OUI (SERIE 3P510)	OUI (SERIE 3PS06)	
<b>Dimensions (mm)</b>	<b>A</b>	139,0	145,0	149	133
	<b>B</b>	22,0	29,5	30	22
	<b>C</b>	51,3	60,2	51,3	51,3
	<b>D</b>	133,0	133,0	133	188
	<b>E</b>	133,5	133,5	133,5	105
	<b>F</b>	157,0	160,0	157	234

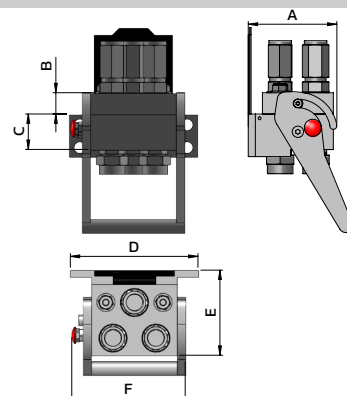
**PLATINE MULTI-FASTER**

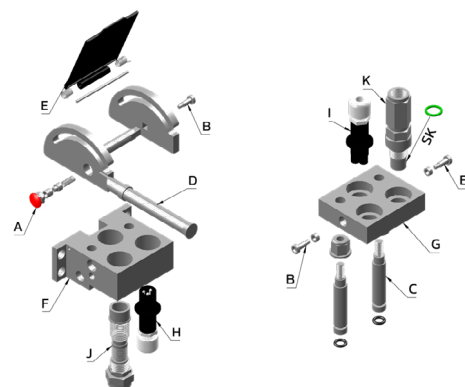

SERIE	P606	P608	P808	P5065	
<b>3D model</b>					
<b>Nb d'emplacements</b>	6	6	8	5	
<b>Combinaisons principales</b>	6 coupleurs	6, 5 ou 4 coupleurs OU 5 coupleurs + 1 fiche électrique OU 4 coupleurs + 2 fiches électriques	8 ou 6 coupleurs OU 7 coupleurs + 1 fiche électrique	5, 4, 3 ou 2 coupleurs	
<b>Tailles des coupleurs</b>	<b>DASH</b>	6	8	3 X 4 2 X 6	
	<b>mm</b>	10	12	3 X 6 2 X 10	
	<b>inch</b>	3/8"	1/2" (ou fiche électrique)	3 X 1/4" 2 x 3/8"	
<b>Code couleur</b>					
<b>PN (bar)</b>	250	250	250	250	
<b>Débit (L/m)</b>	40	70	70	20 40	
<b>Applications principales</b>	Agricole ■ BTP ■ Maritime ■ Mines et plateformes pétrolières ■ Entretien routier	Agricole (chargeur frontal) ■ BTP ■ Manutention ■ Industrie	Agricole (chargeur frontal) ■ BTP ■ Manutention ■ Industrie	Agricole (outils de récolte fron- taux moissonneuse-batteuse, déchaumeur, etc.) ■ Engins forestiers (tête d'abattage)	
<b>Accouplement sous pression autorisé</b>	OUI (SERIE 3P606)	OUI (SERIE 3P608)	OUI (SERIE 3P808)	OUI (SERIE 3P5065)	
<b>Dimensions (mm)</b>	<b>A</b>	116	135	133	103
	<b>B</b>	24	30	30	22
	<b>C</b>	51,3	60,2	60,2	51,3
	<b>D</b>	188	144	188	120
	<b>E</b>	100	108	108	110
	<b>F</b>	234	203	247	140

**MONTAGE PLATINE**



PLATINES	PB06	P206	P208	P306	P506	P508
<b>A : KIT DE VERROUILLAGE</b> (Platine Fixe)	CF-KITSP5S	CF-KITSP4	CF-KITSP5S	CF-KITSP5S	CF-KITSP5S	CF-KITSP5S
<b>B : VIS DE VERROUILLAGE</b> (Platine Mobile)	CF-KITVPB6	CF-KITVP4	CF-KITVP8	CF-KITVP8	CF-KITVP4	CF-KITVP8
<b>C : GUIDE + ECROU</b> (Platine Mobile)	CF-KITGP4	CF-KITGP4	CF-KITGP4	CF-KITGP4	CF-KITGP4	CF-KITGP4
<b>D : LEVIER</b> (Platine Fixe)	CF-KITLPB06	CF-KITLP206	CF-KITLP208	CF-KITLP208	CF-KITLP506	CF-KITP508
<b>E : COUVERCLE ANTI-POUSSIÈRE</b> (Platine Fixe)	CF-KITTAPB06	CF-KITTAP2	CF-KITTAP2	CF-KITTAP2	CF-KITTAP5	CF-KITTAP5
<b>F : PLATINE FIXE</b> (Complete Sans Coupleur)	CF-KITPB06FL	CF-KITP206FL	CF-KITP208FL	CF-KITP306FL	CF-KITP506FL	CF-KITP508FL
<b>G : PLATINE MOBILE</b> (Complete Sans Coupleur)	CF-KITPB06M	CF-KITP206M	CF-KITP208M	CF-KITP306M	CF-KITP506M	CF-KITP508M
<b>H : FICHE ELECTRIQUE</b> (Platine Fixe)			SE REFERER A LA PAGE -CPL 55-			
<b>I : FICHE ELECTRIQUE</b> (Platine Mobile)			SE REFERER A LA PAGE -CPL 55-			
<b>J : COUPLEUR</b> (Platine Fixe)			SE REFERER A LA PAGE -CPL 54-			
<b>K : COUPLEUR</b> (Platine Mobile)			SE REFERER A LA PAGE -CPL 55-			
<b>SK : JOINT</b>	CF-SKMF38	CF-SKMF38	CF-SKMF12	CF-SKMF38 / CF-SKMF12	CF-SKMF38	CF-SKMF12
<b>SUPPORT DE PARKING</b>	CF-SPU	CF-SPU	CF-SPU	CF-SPU	CF-SPU	CF-SPU
<b>SUPPORT MOBILE</b>	CF-SPB06	CF-SP2	CF-SP2	-	CF-SP5	CF-SP5

PLATINES	P510	PS06	P606	P608	P808	P5065
<b>A : KIT DE VERROUILLAGE</b> (Platine Fixe)	CF-KITSP5S	CF-KITSP5S	CF-KITSP5S	CF-KITSP5S	CF-KITSP5S	CF-KITSP5S
<b>B : VIS DE VERROUILLAGE</b> (Platine Mobile)	CF-KITVP8	CF-KITVP4	CF-KITVP4	CF-KITVP8	CF-KITVP8	CF-KITVP4
<b>C : GUIDE + ECROU</b> (Platine Mobile)	CF-KITGP4	CF-KITGP4	CF-KITGP4	CF-KITGP4	CF-KITGP8	CF-KITGP4
<b>D : LEVIER</b> (Platine Fixe)	CF-KITP510	CF-KITLP606	CF-KITLP606	CF-KITLP608	CF-KITLP808	CF-KITLP506
<b>E : COUVERCLE ANTI-POUSSIÈRE</b> (Platine Fixe)	CF-KITTAP5	CF-KITTAP6	CF-KITTAP6	CF-KITTAP608	CF-KITTAP8	CF-KITTAP5
<b>F : PLATINE FIXE</b> (Complete Sans Coupleur)	CF-KITP510FL	CF-KITPS06FL	CF-KITP606FL	CF-KITP608FL	CF-KITP808FL	CF-KITP5065FL
<b>G : PLATINE MOBILE</b> (Complete Sans Coupleur)	CF-KITP510M	CF-KITPS06M	CF-KITP606M	CF-KITP608M	CF-KITP808M	CF-KITP5065M
<b>H : FICHE ELECTRIQUE</b> (Platine Fixe)			SE REFERER A LA PAGE -CPL 55-			
<b>I : FICHE ELECTRIQUE</b> (Platine Mobile)			SE REFERER A LA PAGE -CPL 55-			
<b>J : COUPLEUR</b> (Platine Fixe)			SE REFERER A LA PAGE -CPL 54-			
<b>K : COUPLEUR</b> (Platine Mobile)			SE REFERER A LA PAGE -CPL 55-			
<b>SK : JOINT</b>	CF-SKMF12 / CF-SKMF34	CF-SKMF38	CF-SKMF38	CF-SKMF12	CF-SKMF12	CF-SKMF14 / CF-SKMF38
<b>SUPPORT DE PARKING</b>	CF-SPU	CF-SPU	CF-SPU	CF-SPU	CF-SPU	CF-SPU
<b>SUPPORT MOBILE</b>	CF-SP510	CF-SP5	CF-SP6	CF-SP608	CF-SP8	CF-SP5065

**CPL POUR PLATINE FIXE**

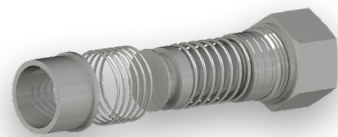
Référence	Corps	F	A	Ø Acc	H	Pour série
CF-KIT2FNB14GASF	1/4" 	F 1/4" BSP	57,9	16,2	24	P5065
CF-KIT2FNB14-38SF		F 9/16" UNF	57,8	16,2	24	



Référence	Corps	F	A	Ø Acc	H	Pour série
CF-KIT2FNB38GASF	3/8" 	F 3/8" BSP	72,5	19,7	27	PS06 / PB206 / P206 / P306 / P506 / P606 / PS5065
CF-KIT2FNB38-12GAS		F 1/2" BSP	74,3	19,7	27	
CF-KIT2FNB38-2/18F		12L - M18X150	72,5	19,7	27	
CF-KIT2FNB38-2/22F		15L - M22X150	73,5	19,7	27	
CF-KIT2FNB38-12SF		F 3/4" UNF	74,3	19,7	27	
CF-KIT2FNB3811/12S		M 13/16" UN ORFS	81,7	19,7	27	

Référence	Corps	F	A	Ø Acc	H	Pour série
CF-KIT2FNB12GASF	1/2" 	F 1/2" BSP	80,8	24,9	30	P208 / P306 / P508 / P510 / P608 / P808
CF-KIT2FNB12-34GF		F 3/4" BSP	84,2	24,9	34	
CF-KIT2FNB12NPTF		F 1/2" NPT	81	24,9	30	
CF-KIT2FNB12-2/22F		15L - M22X150	84	24,9	30	
CF-KIT2FNB12-12SF		F SAE 3/4"	81	24,9	30	
CF-KIT2FNB12-34SF		F 1"1/16 UN	88	24,9	34	
CF-KIT2FNB1211/12S		M 13/16" UN ORFS	84,8	24,9	30	

Référence	Corps	F	A	Ø Acc	H	Pour série
CF-KIT2FNB34GASF	3/4" 	F 3/4" BSP	100,6	30	42	P510
CF-KIT2FNB34NPT		F 3/4" NPT	100,6	30	42	
CF-KIT2FNB34-34SF		F 1"1/16 UN	100,7	30	42	

**CPL POUR PLATINE MOBILE**

Référence	Corps	F	A	Ø Acc	H	C.S.P*	KITJOINT	Pour série
CF-KIT2FNP14GASM		F 1/4" BSP	71,3	16,1	16	N		
CF-KIT2FNP14-38SM	1/4"	F 9/16" UNF	72,8	16,1	16	N	CF-SKMF14	P5065
CF-KIT3FNP14GASM		F 1/4" BSP	111,6	16,1	16	O		
CF-KIT3FNP14-38SM		F 9/16" UNF	113	16,1	16	O		

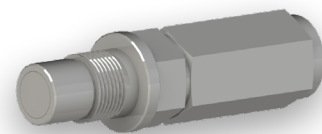

Référence	Corps	F	A	Ø Acc	H	C.S.P*	KITJOINT	Pour série
CF-KIT2FNP38GASM		F 3/8" BSP	77,3	19,6	27	N		
CF-KIT2FNP38-12GAS		F 1/2" BSP	81,3	19,6	27	N		
CF-KIT2FNP38-2/18M		12L - M18X150	78,5	19,6	27	N		
CF-KIT2FNP38-2/22M		15L - M22X150	78,3	19,6	27	N		
CF-KIT2FNP38-12SM	3/8"	F 3/4" UNF	81,3	19,6	27	N	CF-SKMF38	P206 /
CF-KIT2FNP38-38SM		F 9/16" UNF	77,3	19,6	27	N		P306 /
CF-KIT2FNP3811/12S		M 13/16" UN ORFS	79,1	19,6	27	N		P506 /
CF-KIT3FNP38GASM		F 3/8" BSP	107,3	19,6	27	O		P606 /
CF-KIT3FNP38-12GM		F 1/2" BSP	108,3	19,6	27	O		P506 /
CF-KIT3FNP38-2/22M		15L - M22X150	108,5	19,6	27	O		P808
CF-KIT3FNP38-12SM		F 3/4" UNF	108,4	19,6	27	O		
CF-KIT3FNP3811/12S		M 13/16" UN ORFS	109,5	19,6	27	O		

Référence	Corps	F	A	Ø Acc	H	C.S.P*	KITJOINT	Pour série
CF-KIT2FNP12GASM		F 1/2" BSP	87	24,9	32	N		
CF-KIT2FNP12NPTM		F 1/2" NPT	87	24,9	32	N		
CF-KIT2FNP12-2/22M		15L - M22X150	85,7	24,9	32	N		
CF-KIT2FNP12-12SM	1/2"	F 3/4" UNF	87	24,9	32	N	CF-SKMF12	P208 /
CF-KIT2FNP12-34GM		F 3/4" BSP	92	24,9	34	N		P306 /
CF-KIT2FNP12-34SM		F 1"1/16 UN	92	24,9	34	N		P508 /
CF-KIT2FNP1211/12S		M 13/16" UN ORFS	86,7	24,9	32	N		P510 /
CF-KIT3FNP12GASM		F 1/2" BSP	121,1	24,9	34	O		P608 /
CF-KIT3FNP12-2/22M		15L - M22X150	119	24,9	34	O		P808
CF-KIT3FNP12-12/12M		F 3/4" UNF	120,7	24,9	34	O		
CF-KIT3FNP12-34SM		F 1"1/16 UN	122,7	24,9	34	O		

Référence	Corps	F	A	Ø Acc	H	C.S.P*	KITJOINT	Pour série
CF-KIT2FNP34GASM	3/4"	F 3/4" BSP	106,5	30	41	N	CF-SKMF34	P510
CF-KIT2FNP34-34SM		F 1"1/16 UN	104,9	30	41	N		
CF-KIT3FNP34GASM		F 3/4" BSP	132,9	30	42	O		
CF-KIT3FNP34-34SM		F 1"1/16 UN	132,9	30	42	O		

**FICHE ELECTRIQUE**

FICHE ELECTRIQUE POUR PLATINE FIXE MULTI-FASTER

Référence	Corps	Nb de fiches	Pour platine
CF-KITSPELO8-3F	1/2"	3	P306 / P508 / P510 / P608 / P808
CF-KITSPELO8-7F		7	

FICHE ELECTRIQUE POUR PLATINE MOBILE MULTI-FASTER

Référence	Corps	Nb de fiches	Pour platine
CF-KITSPELO8-3M	1/2"	3	P306 / P508 / P510 / P608 / P808
CF-KITSPELO8-7M		7	

# COUPLEURS STUCCHI

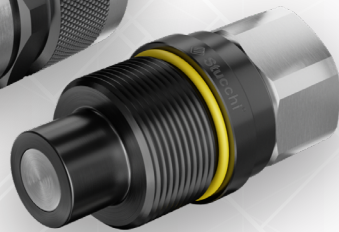
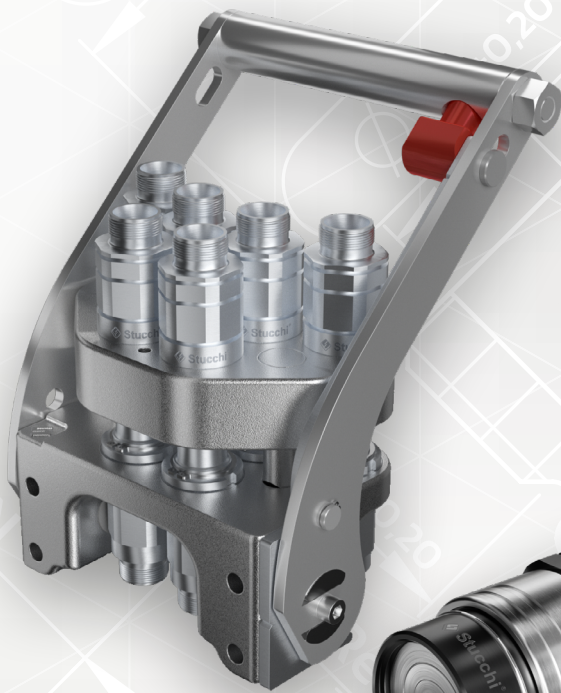

SECTION A-A

## CPL A CLAPET ISO A / BIR

Référence	Corps	F	A	D	H	Débit maxi (l/m)	PN (bar)
<b>BSPP &gt;&gt;&gt;</b>							
CS-BIR14BSPF	1/4"	F 1/4"	47,1	26,0	19	12	350
CS-BIR38BSPF	3/8"	F 3/8"	56,1	31,0	22	46	300
CS-BIR12BSPF	1/2"	F 1/2"	63,3	38,0	27	90	250
CS-BIR34BSPF	3/4"	F 3/4"	82,2	48,0	38	148	250
CS-BIR100BSPF	1"	F 1"	97,1	54,0	45	200	230
CS-BIR114BSPF	1 1/4"	F 1 1/4"	117,2	65,0	50	378	230
CS-BIR112BSPF	1 1/2"	F 1 1/2"	135,3	80,0	60	750	180
CS-BIR200BSPF	2"	F 2"	160,2	100,0	75	1000	130

Référence	Corps	F	A	ØAcc	H	Débit maxi (l/m)	PN (bar)
<b>BSPP &gt;&gt;&gt;</b>							
CS-BIR14BSPM	1/4"	F 1/4"	32,0	11,8	19	12	350
CS-BIR38BSPM	3/8"	F 3/8"	38,0	17,3	22	46	300
CS-BIR12BSPM	1/2"	F 1/2"	44,5	20,5	27	90	250
CS-BIR34BSPM	3/4"	F 3/4"	55,0	29,1	36	148	250
CS-BIR100BSPM	1"	F 1"	63,1	34,3	41	200	230
CS-BIR114BSPM	1 1/4"	F 1 1/4"	75,0	45,0	55	378	230
CS-BIR112BSPM	1 1/2"	F 1 1/2"	85,0	55,0	60	750	180
CS-BIR200BSPM	2"	F 2"	100,0	65,0	75	1000	130

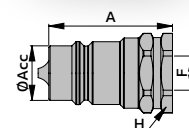
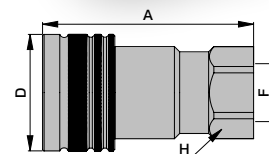

**MATIÈRE**  
Acier - CR3

**JOINT**  
NBR - PTFE

**TEMPÉRATURE DE SERVICE**  
-20 à +100 °C

**INTERCHANGEABLE**  
Selon ISO 7241-A

## CPL PUSH-PULL ISO A / I-IP

Référence	Corps	F	A	D	H	Débit maxi (l/m)	PN (bar)
CS-IP12L12F	1/2"	12L - M18X150	65,6	38,0	27	90	250
CS-IP12L15F	1/2"	15L - M22X150	66,6	38,0	27	90	250

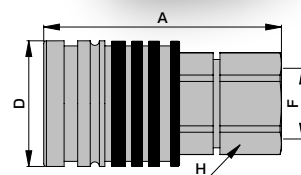

**MATIÈRE**  
Acier - CR3

**JOINT**  
NBR - PTFE

**TEMPÉRATURE DE SERVICE**  
-20 à +100 °C

**INTERCHANGEABLE**  
Selon ISO 7241-A

**CPL A CLAPET STD / IR-V**

Référence	Corps	F	A	D	H	Débit maxi (l/m)	PN (bar)
<b>BSPP &gt;&gt;&gt;</b>							
CS-IR14VBSPF	1/4"	F 1/4"	50,4	27,0	19	24	300
CS-IR38VBSPF	3/8"	F 3/8"	58,3	34,0	24	46	300
CS-BIR12BSPF	1/2"	F 1/2"	63,3	38,0	27	90	250
CS-IR34VBSPF	3/4"	F 3/4"	90,3	48,0	38	148	250
CS-IR100VBSPF	1"	F 1"	97,6	54,0	45	200	200

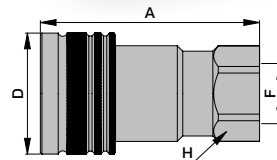

Référence	Corps	F	A	ØAcc	H	Débit maxi (l/m)	PN (bar)
<b>BSPP &gt;&gt;&gt;</b>							
CS-IR14VBSPM	1/4"	F 1/4"	32,5	14,2	19	24	300
CS-IR38VBSPM	3/8"	F 3/8"	38,0	19,0	24	46	300
CS-BIR12BSPM	1/2"	F 1/2"	44,5	20,5	27	90	250
CS-IR34VBSPM	3/4"	F 3/4"	59,0	26,9	36	148	250
CS-IR100VBSPM	1"	F 1"	64,1	31,4	41	200	200

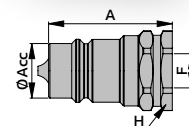

**MATIÈRE**  
Acier - CR3

**JOINT**  
NBR - PTFE

**TEMPÉRATURE DE SERVICE**  
-20 à +100 °C

**INTERCHANGEABLE**  
DN 12 interchangeable selon  
ISO 7241-A

**ACCESSOIRES POUR COUPLEURS STD / IR-V**

Référence	Description	Taille	Pour coupleur	Type	Matière	Couleur
CS-BIR14VM	Bouchon	1/4"	Mâle	IR-V	PVC	Rouge
CS-BIR38VM	Bouchon	3/8"	Mâle	IR-V	PVC	Rouge
CS-BIR12VM	Bouchon	1/2"	Mâle	IR-V	PVC	Rouge
CS-BIR34VM	Bouchon	3/4"	Mâle	IR-V	PVC	Rouge
CS-BIR100VM	Bouchon	1"	Mâle	IR-V	PVC	Rouge
CS-BIR14VF	Bouchon	1/4"	Femelle	IR-V	PVC	Rouge
CS-BIR38VF	Bouchon	3/8"	Femelle	IR-V	PVC	Rouge
CS-BIR12VF	Bouchon	1/2"	Femelle	IR-V	PVC	Rouge
CS-BIR34VF	Bouchon	3/4"	Femelle	IR-V	PVC	Rouge
CS-BIR100VF	Bouchon	1"	Femelle	IR-V	PVC	Rouge



## CPL A CLAPET ISO B / IRB

Référence	Corps	F	A	D	H	Débit maxi (l/m)	PN (bar)
<b>BSPP &gt;&gt;&gt;</b>							
CS-IRB18BSPF	1/8"	F 1/8"	48,8	23,0	14	6	350
CS-IRB14BSPF	1/4"	F 1/4"	57,0	27,0	19	24	350
CS-IRB38BSPF	3/8"	F 3/8"	66,0	34,0	24	46	300
CS-IRB12BSPF	1/2"	F 1/2"	73,9	42,0	27	90	280
CS-IRB34BSPF	3/4"	F 3/4"	90,1	50,0	36	148	230
CS-IRB100BSPF	1"	F 1"	106,2	60,0	41	200	180

Référence	Corps	F	A	ØAcc	H	Débit maxi (l/m)	PN (bar)
<b>BSPP &gt;&gt;&gt;</b>							
CS-IRB18BSPM	1/8"	F 1/8"	30,0	10,8	14	6	350
CS-IRB14BSPM	1/4"	F 1/4"	35,0	14,2	19	24	350
CS-IRB38BSPM	3/8"	F 3/8"	41,0	19,1	24	46	300
CS-IRB12BSPM	1/2"	F 1/2"	46,0	23,5	27	90	280
CS-IRB34BSPM	3/4"	F 3/4"	55,0	31,4	36	148	230
CS-IRB100BSPM	1"	F 1"	66,0	37,7	41	200	180

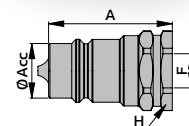
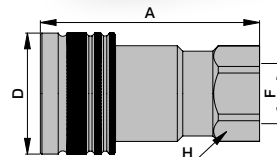

**MATIÈRE**  
Acier - CR3

**JOINT**  
NBR - PTFE

**TEMPÉRATURE DE SERVICE**  
-20 à +100 °C

**INTERCHANGEABLE**  
Selon ISO 7241-B

## ACCESSOIRES POUR COUPLEURS ISO B / IRB

Référence	Description	Taille	Pour coupleur	Type	Matière	Couleur
CS-BIRB14M	Bouchon	1/4"	Mâle	IRB	PVC	Rouge
CS-BIRB38M	Bouchon	3/8"	Mâle	IRB	PVC	Rouge
CS-BIRB12M	Bouchon	1/2"	Mâle	IRB	PVC	Rouge
CS-BIRB34M	Bouchon	3/4"	Mâle	IRB	PVC	Rouge
CS-BIRB100M	Bouchon	1"	Mâle	IRB	PVC	Rouge
CS-BIRB14F	Bouchon	1/4"	Femelle	IRB	PVC	Rouge
CS-BIRB38F	Bouchon	3/8"	Femelle	IRB	PVC	Rouge
CS-BIRB12F	Bouchon	1/2"	Femelle	IRB	PVC	Rouge
CS-BIRB34F	Bouchon	3/4"	Femelle	IRB	PVC	Rouge
CS-BIRB100F	Bouchon	1"	Femelle	IRB	PVC	Rouge



**CPL ANTI-POLLUTION ISO 16028 / A**

Référence	Corps	F	A	D	H	Débit maxi (l/m)	PN (bar)
<b>BSPP &gt;&gt;&gt;</b>							
CS-A7ZN1/4BSPF	1/4"	F 1/4"	53,1	28,0	27	24	420
CS-A9ZN3/8BSPF	3/8"	F 3/8"	64,8	32,0	30	46	350
CS-A9ZN1/2BSPF	3/8"	F 1/2"	69,8	32,0	30	46	350
CS-A13ZN1/2BSPF	1/2"	F 1/2"	76,8	38,0	36	90	330
CS-A13ZN3/4BSPF	1/2"	F 3/4"	83,8	38,0	36	90	330
CS-A15ZN3/4BSPF	5/8"	F 3/4"	84,0	42,0	41	148	330
CS-A17ZN3/4BSPF	3/4"	F 3/4"	96,8	48,0	46	200	330
CS-A17ZN1BSPF	3/4"	F 1"	98,8	48,0	46	200	330
CS-A21ZN1-1/4BSPF	1"	F 1"1/4	105,8	55,0	55	378	300

Référence	Corps	F	A	ØAcc	H	Débit maxi (l/m)	PN (bar)
<b>BSPP &gt;&gt;&gt;</b>							
CS-A7ZN1/4BSPM	1/4"	F 1/4"	47,9	16,1	22	24	420
CS-A9ZN3/8BSPM	3/8"	F 3/8"	60,0	19,7	27	46	350
CS-A9ZN1/2BSPM	3/8"	F 1/2"	62,5	19,7	27	46	350
CS-A13ZN1/2BSPM	1/2"	F 1/2"	68,0	24,5	36	90	330
CS-A13ZN3/4BSPM	1/2"	F 3/4"	70,5	24,5	36	90	330
CS-A15ZN3/4BSPM	5/8"	F 3/4"	73,0	27,0	41	148	330
CS-A17ZN3/4BSPM	3/4"	F 3/4"	83,7	30,0	46	200	330
CS-A17ZN1BSPM	3/4"	F 1"	83,7	30,0	46	200	330
CS-A21BSPM*	1"	F 1"	96,8	36,0	55	378	300
CS-A21ZN1-1/4BSPM	1"	F 1"1/4	90,0	36,0	55	378	300

\* Traitement CR3

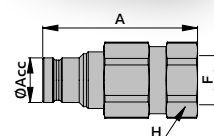
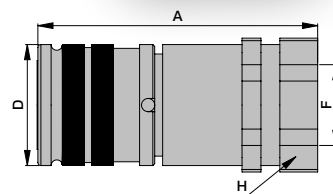
**MATIÈRE**  
 Acier - ZN

**JOINT**  
 NBR - PTFE

**TEMPÉRATURE DE SERVICE**  
 -20 à +100 °C

**INTERCHANGEABLE**  
 Selon ISO 16028

## CPL ANTI-POLLUTION CSP ISO 16028 / MALE APM

Référence	Corps	F	A	ØAcc	H	Débit maxi (l/m)	PN (bar)
<b>BSPP &gt;&gt;&gt;</b>							
CS-APM93/8BSPM	3/8"	F 3/8"	80,0	19,7	27	46	350
CS-APM91/2BSPM	3/8"	F 1/2"	82,5	19,7	27	46	330
CS-APM131/2BSPM	1/2"	F 1/2"	91,0	24,5	36	90	330
CS-APM133/4BSPM	1/2"	F 3/4"	93,5	24,5	36	90	330
CS-APM153/4BSPM	5/8"	F 3/4"	95,0	27,0	36	148	330
CS-APM171BSPM	3/4"	F 1"	108,5	30,0	46	200	330
CS-APM211-1/4BSPM	1"	F 1"1/4	123,5	36,0	55	378	300
CS-APM301-1/2BSPM	1"1/2	F 1"1/2	146,9	57,0	70	750	270

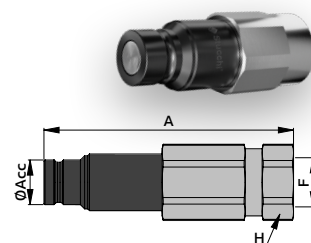

**MATIÈRE**  
Acier - CR3 & QPQ

**JOINT**  
NBR - PTFE

**TEMPÉRATURE DE SERVICE**  
-20 à +100 °C

**CONNEXION**  
Connectable sous pression :  
mâle uniquement

## CPL ANTI-POLLUTION CSP ISO 16028 / FEM A-HD

Référence	Corps	F	A	D	H	Débit maxi (l/m)	PN (bar)
<b>BSPP &gt;&gt;&gt;</b>							
CS-A9HD3/8BSPF	3/8"	F 3/8"	64,8	32,0	30	46	350
CS-A9HD1/2BSPF	3/8"	F 1/2"	69,8	32,0	30	46	350
CS-A13HD1/2BSPF	1/2"	F 1/2"	76,8	40,0	36	90	330
CS-A13HD3/4BSPF	1/2"	F 3/4"	83,8	40,0	36	90	330

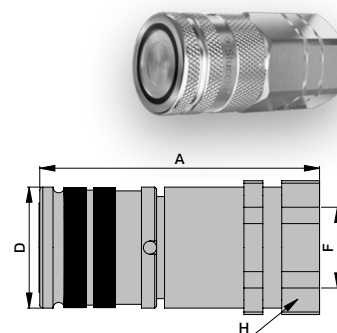

**MATIÈRE**  
Acier - CR3

**JOINT**  
NBR - PTFE

**TEMPÉRATURE DE SERVICE**  
-20 à +100 °C

**CONNEXION**  
Connectable sous pression :  
femelle uniquement

**CPL A VISSER ANTI-POLLUTION / VEP-P**

Référence	Corps	F	A	ACC	H	Débit maxi (l/m)	PN (bar)
<b>BSPP &gt;&gt;&gt;</b>							
CS-VEP71/4BSPP	1/4"	F 1/4"	54,1	M30X200	27	24	420
CS-VEP9P3/8BSPP	3/8"	F 3/8"	65,8	M33X200	30	46	330
CS-VEP9P1/2BSPP	3/8"	F 1/2"	70,8	M33X200	30	46	330
CS-VEP13P1/2BSPP	1/2"	F 1/2"	77,8	M40X300	36	90	330
CS-VEP13P3/4BSPP	1/2"	F 3/4"	84,8	M40X300	36	90	330
CS-VEP15P3/4BSPP	5/8"	F 3/4"	84,9	M45X300	41	148	330
CS-VEP17P3/4BSPP	3/4"	F 3/4"	97,7	M50X300	46	200	330
CS-VEP17P1BSPP	3/4"	F 1"	99,7	M50X300	46	200	330
CS-VEP21P1BSPP	1"	F 1"	105,8	M58X300	55	378	300
CS-VEP21P1-1/4BSPP	1"	F 1"1/4	106,8	M58X300	55	378	300
CS-VEP30P1-1/4BSPP	1"1/2	F 1"1/4	133,5	80X40 TpF	65	750	270
CS-VEP30P1-1/2BSPP	1"1/2	F 1"1/2	133,5	80X40 TpF	65	750	270
CS-VEP45P2BSPP	2"	F 2"	224,8	M130X600	90	1000	270

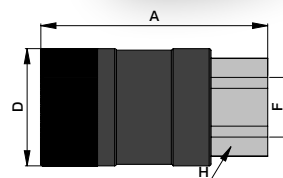

Référence	Corps	F	A	ACC	H	Débit maxi (l/m)	PN (bar)
<b>BSPP &gt;&gt;&gt;</b>							
CS-VEP71/4BSPM	1/4"	F 1/4"	71,0	M30X200	22	24	600
CS-VEP9P3/8BSPM	3/8"	F 3/8"	82,5	M33X200	27	46	550
CS-VEP9P1/2BSPM	3/8"	F 1/2"	85,0	M33X200	27	46	550
CS-VEP13P1/2BSPM	1/2"	F 1/2"	95,0	M40X300	36	90	550
CS-VEP13P3/4BSPM	1/2"	F 3/4"	97,4	M40X300	36	90	550
CS-VEP15P3/4BSPM	5/8"	F 3/4"	99,0	M45X300	36	148	550
CS-VEP17P3/4BSPM	3/4"	F 3/4"	113,6	M50X300	46	200	500
CS-VEP17P1BSPM	3/4"	F 1"	113,6	M50X300	46	200	500
CS-VEP21P1BSPM	1"	F 1"	123,4	M58X300	55	378	470
CS-VEP21P1-1/4BSPM	1"	F 1"1/4	123,4	M58X300	55	378	470
CS-VEP30P1-1/4BSPM	1"1/2	F 1"1/4	150,0	80X4 TpF	65	750	400
CS-VEP30P1-1/2BSPM	1"1/2	F 1"1/2	150,0	80X4 TpF	65	750	400
CS-VEP45P2BSPM	2"	F 2"	218,4	M130X600	90	1000	350

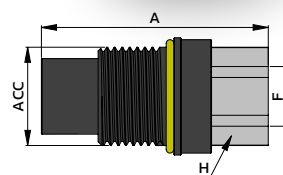

**MATIÈRE**  
Acier - CR3 & QPQ

**JOINT**  
NBR - PTFE

**TEMPÉRATURE DE SERVICE**  
-20 à +100 °C

**CONNEXION**  
Connectable et déconnectable sous pression, voir tableau

Série	Corps	CSP pression maxi (bar)			DSP pression maxi (bar)
		Male seul	Femelle seule	Male & femelle	
VEP7	1/4"	300	250	250	250
VEP9P	3/8"	250	250	250	250
VEP13P	1/2"	250	250	200	200
VEP15P	5/8"	250	250	200	200
VEP17P	3/4"	250	250	150	150
VEP21P	1"	250	250	150	150
VEP30P	1"1/2	250	250	50	50
VEP45P	2"	250	200	20	20

**CPL A VISSER ANTI-POLLUTION EXTREME / VEP-HD**

Référence	Corps	F	A	D	H	Débit maxi (l/m)	PN (bar)
<b>BSPP &gt;&gt;&gt;</b>							
CS-VEP15HD3/4BSPP	5/8"	F 3/4"	84,9	53,8	41	148	330
CS-VEP17HD3/4BSPP	3/4"	F 3/4"	99,7	58,8	46	200	330
CS-VEP17HD1BSPP	3/4"	F 1"	99,7	58,8	46	200	330
CS-VEP21HD1BSPP	1"	F 1"	106,8	69,8	55	378	300
CS-VEP21HD1-1/4BSF	1"	F 1"1/4	106,8	69,8	55	378	300
CS-VEP25HDZNI-1/4F	1"1/4	F 1"1/4	115,6	80,0	55	576	300
CS-VEP30HD1-1/4BSF	1"1/2	F 1"1/4	133,5	95,0	65	750	270
CS-VEP30HD1-1/2BSF	1"1/2	F 1"1/2	133,5	95,0	65	750	270
<b>SAE &gt;&gt;&gt;</b>							
CS-VEP15HD3/4SAEF	5/8"	F 3/4" UNF	84,9	53,8	41	148	330

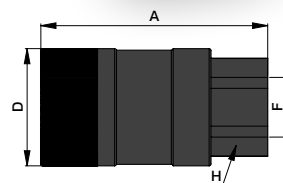

Référence	Corps	F	A	ACC	H	Débit maxi (l/m)	PN (bar)
<b>BSPP &gt;&gt;&gt;</b>							
CS-VEP15HD3/4BSPM	5/8"	F 3/4"	106,0	M45X300	36	148	550
CS-VEP17HD3/4BSPM	3/4"	F 3/4"	124,0	M50X300	46	200	500
CS-VEP17HD1BSPM	3/4"	F 1"	124,0	M50X300	46	200	500
CS-VEP21HD1BSPM	1"	F 1"	133,4	M58X300	55	378	470
CS-VEP21HD1-1/4BSM	1"	F 1"1/4	133,4	M58X300	55	378	470
CS-VEP25HDZNI-1/4M	1"1/4	F 1"1/4	141,8	Rd68X1/6	65	576	420
CS-VEP30HD1-1/4BSM	1"1/2	F 1"1/4	150,0	80X4 TpF	65	750	400
CS-VEP30HD1-1/2BSM	1"1/2	F 1"1/2	150,0	80X4 TpF	65	750	400
<b>SAE &gt;&gt;&gt;</b>							
CS-VEP15HD3/4SAEM	5/8"	F 3/4" UNF	106,0	M45X300	41	148	550

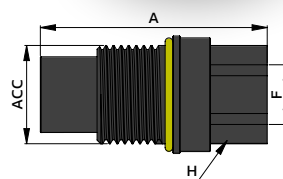
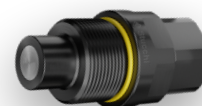

**MATIÈRE**  
Acier - CR3 & QPQ

**JOINT**  
NBR - PTFE

**TEMPÉRATURE DE SERVICE**  
-20 à +100 °C

- Connectable et déconnectable sous pression, voir tableau
- Extrême résistance à l'usure
- DN32 traitement zinc nickel par défaut
- Interchangeable avec la série VEP-P

Série	Corps	CSP pression maxi (bar)			DSP pression maxi (bar)
		Male seul	Femelle seule	Male & femelle	
VEP15HD	5/8"	250	250	200	200
VEP17HD	3/4"	250	250	150	150
VEP21HD	1"	250	250	150	150
VEP25HDZN	1"1/4	250	250	50	50
VEP30HD	1"1/2	250	250	50	50

**ACCESSOIRES POUR COUPLEURS A VISSER / VEP-P & VEP-HD**

Référence	Description	Taille	Pour coupleur	Type	Matière	Couleur
<b>CS-BVEP7M-AL</b>	Bouchon	1/4"	Mâle	VEP-P	Alu	Alu
<b>CS-BVEP9M-AL</b>	Bouchon	3/8"	Mâle	VEP-P	Alu	Alu
<b>CS-BVEP13M-AL</b>	Bouchon	1/2"	Mâle	VEP-P	Alu	Alu
<b>CS-BVEP13PM</b>	Bouchon	1/2"	Mâle	VEP-P	PVC	Noir
<b>CS-BVEP15M-AL</b>	Bouchon	5/8"	Mâle	VEP-P / VEP-HD	Alu	Alu
<b>CS-BVEP15PM</b>	Bouchon	5/8"	Mâle	VEP-P / VEP-HD	PVC	Noir
<b>CS-BVEP17M-AL</b>	Bouchon	3/4"	Mâle	VEP-P / VEP-HD	Alu	Alu
<b>CS-BVEP17PM</b>	Bouchon	3/4"	Mâle	VEP-P / VEP-HD	PVC	Noir
<b>CS-BVEP21M-AL</b>	Bouchon	1"	Mâle	VEP-P / VEP-HD	Alu	Alu
<b>CS-BVEP21PM</b>	Bouchon	1"	Mâle	VEP-P / VEP-HD	PVC	Noir
<b>CS-BVEP25M-AL</b>	Bouchon	1"1/4	Mâle	VEP-HD	Alu	Alu
<b>CS-BVEP30M-AL</b>	Bouchon	1"1/2	Mâle	VEP-P / VEP-HD	Alu	Alu
<b>CS-BVEP30PM</b>	Bouchon	1"1/2	Mâle	VEP-P / VEP-HD	PVC	Noir
<b>CS-BVEP45M-AL</b>	Bouchon	2"	Mâle	VEP-P	Alu	Alu
<b>CS-BVEP7F-AL</b>	Bouchon	1/4"	Femelle	VEP-P	Alu	Alu
<b>CS-BVEP9F-AL</b>	Bouchon	3/8"	Femelle	VEP-P	Alu	Alu
<b>CS-BVEP13F-AL</b>	Bouchon	1/2"	Femelle	VEP-P	Alu	Alu
<b>CS-BVEP13PF</b>	Bouchon	1/2"	Femelle	VEP-P	PVC	Noir
<b>CS-BVEP15F-AL</b>	Bouchon	5/8"	Femelle	VEP-P / VEP-HD	Alu	Alu
<b>CS-BVEP15PF</b>	Bouchon	5/8"	Femelle	VEP-P / VEP-HD	PVC	Noir
<b>CS-BVEP17F-AL</b>	Bouchon	3/4"	Femelle	VEP-P / VEP-HD	Alu	Alu
<b>CS-BVEP17PF</b>	Bouchon	3/4"	Femelle	VEP-P / VEP-HD	PVC	Noir
<b>CS-BVEP21F-AL</b>	Bouchon	1"	Femelle	VEP-P / VEP-HD	Alu	Alu
<b>CS-BVEP21PF</b>	Bouchon	1"	Femelle	VEP-P / VEP-HD	PVC	Noir
<b>CS-BVEP25F-AL</b>	Bouchon	1"1/4	Femelle	VEP-HD	Alu	Alu
<b>CS-BVEP30F-AL</b>	Bouchon	1"1/2	Femelle	VEP-P / VEP-HD	Alu	Alu
<b>CS-BVEP30PF</b>	Bouchon	1"1/2	Femelle	VEP-P / VEP-HD	PVC	Noir
<b>CS-BVEP45F-AL</b>	Bouchon	2"	Femelle	VEP-P	Alu	Alu



**CPL A VISSER ANTI-POLLUTION RENFORCE / VP-P**

Référence	Corps	F	A	ACC	H	Débit maxi (l/m)	PN (bar)
<b>BSPP &gt;&gt;&gt;</b>							
CS-VP71/4BSPF	1/4"	F 1/4"	52,8	M24X200	27	24	420
CS-VP9P3/8BSPF	3/8"	F 3/8"	64,3	M28X200	30	46	330
CS-VP9P1/2BSPF	3/8"	F 1/2"	69,3	M28X200	30	46	330
CS-VP13P1/2BSPF	1/2"	F 1/2"	76,2	M36X300	36	90	330
CS-VP13P3/4BSPF	1/2"	F 3/4"	83,2	M36X300	36	90	330
CS-VP15P3/4BSPF	5/8"	F 3/4"	83,4	M39X300	41	148	330
CS-VP17P3/4BSPF	3/4"	F 3/4"	96,0	M45X300	46	200	330
CS-VP17P1BSPF	3/4"	F 1"	98,0	M45X300	46	200	330
CS-VP21P1BSPF	1"	F 1"	104,0	M55X300	55	378	300
CS-VP21P1-1/4BSPF	1"	F 1"1/4	105,0	M55X300	55	378	300
CS-VP30P1-1/4BSPF	1"1/2	F 1"1/4	132,2	M72X400	65	750	270
CS-VP30P1-1/2BSPF	1"1/2	F 1"1/2	132,2	M72X400	65	750	270

Référence	Corps	F	A	D	H	Débit maxi (l/m)	PN (bar)
<b>BSPP &gt;&gt;&gt;</b>							
CS-VP71/4BSPM	1/4"	F 1/4"	83,9	35,0	22	24	600
CS-VP9P3/8BSPM	3/8"	F 3/8"	94,5	42,0	27	46	550
CS-VP9P1/2BSPM	3/8"	F 1/2"	94,5	42,0	27	46	550
CS-VP13P1/2BSPM	1/2"	F 1/2"	110,0	49,0	36	90	550
CS-VP13P3/4BSPM	1/2"	F 3/4"	110,0	49,0	36	90	550
CS-VP15P3/4BSPM	5/8"	F 3/4"	110,0	52,0	36	148	550
CS-VP17P3/4BSPM	3/4"	F 3/4"	127,1	60,0	46	200	500
CS-VP17P1BSPM	3/4"	F 1"	127,1	60,0	46	200	500
CS-VP21P1BSPM	1"	F 1"	137,0	76,0	55	378	470
CS-VP21P1-1/4BSPM	1"	F 1"1/4	137,0	76,0	55	378	470
CS-VP30P1-1/4BSPM	1"1/2	F 1"1/4	174,7	94,0	65	750	400
CS-VP30P1-1/2BSPM	1"1/2	F 1"1/2	174,7	94,0	65	750	400

Série	Corps	CSP pression maxi (bar)			DSP pression maxi (bar)
		Male seul	Femelle seule	Male & femelle	
VP7	1/4"	300	250	250	250
VP9P	3/8"	250	250	250	250
VP13P	1/2"	250	250	200	200
VP15P	5/8"	250	250	200	200
VP17P	3/4"	250	250	150	150
VP21P	1"	250	250	150	150
VP30P	1"1/2	250	250	50	50

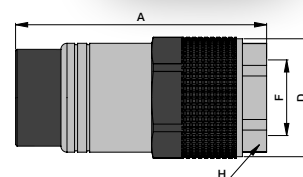
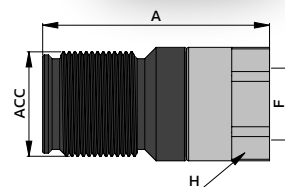

**MATIÈRE**  
Acier - CR3 & QPQ

**JOINT**  
NBR - PTFE

**TEMPÉRATURE DE SERVICE**  
-20 à +100 °C

- Connectable et déconnectable sous pression, voir tableau
- Haute résistance aux impulsions
- Bague de verrouillage anti-déconnexion accidentelle

**ACCESSOIRES POUR COUPLEURS A VISSER / VP-P**

Référence	Description	Taille	Pour coupleur	Type	Matière	Couleur
<b>CS-BVP7M-AL</b>	Bouchon	1/4"	Mâle	VP-P	Alu	Alu
<b>CS-BVP9PM-AL</b>	Bouchon	3/8"	Mâle	VP-P	Alu	Alu
<b>CS-BVP13PM-AL</b>	Bouchon	1/2"	Mâle	VP-P	Alu	Alu
<b>CS-BVP15PM-AL</b>	Bouchon	5/8"	Mâle	VP-P	Alu	Alu
<b>CS-BVP17PM-AL</b>	Bouchon	3/4"	Mâle	VP-P	Alu	Alu
<b>CS-BVP21PM-AL</b>	Bouchon	1"	Mâle	VP-P	Alu	Alu
<b>CS-BVP30PM-AL</b>	Bouchon	1"1/2	Mâle	VP-P	Alu	Alu
<b>CS-BVP7F-AL</b>	Bouchon	1/4"	Femelle	VP-P	Alu	Alu
<b>CS-BVP9PF-AL</b>	Bouchon	3/8"	Femelle	VP-P	Alu	Alu
<b>CS-BVP13PF-AL</b>	Bouchon	1/2"	Femelle	VP-P	Alu	Alu
<b>CS-BVP15PF-AL</b>	Bouchon	5/8"	Femelle	VP-P	Alu	Alu
<b>CS-BVP17PF-AL</b>	Bouchon	3/4"	Femelle	VP-P	Alu	Alu
<b>CS-BVP21PF-AL</b>	Bouchon	1"	Femelle	VP-P	Alu	Alu
<b>CS-BVP30PF-AL</b>	Bouchon	1"1/2	Femelle	VP-P	Alu	Alu

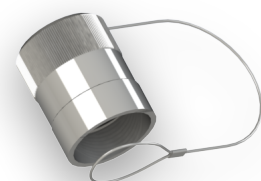

**CPL A VISSER ISO 14541 / VD**

Référence	Corps	F	A	ACC	H	Débit maxi (l/m)	PN (bar)
<b>BSPP &gt;&gt;&gt;</b>							
CS-VD141/4BSPP	1/4"	F 1/4"	61,7	M24X200	19	24	450
CS-VD381/4BSPP	3/8"	F 1/4"	64,3	M28X200	22	46	450
CS-VD383/8BSPP	3/8"	F 3/8"	67,3	M28X200	22	46	450
CS-VD123/8BSPP	1/2"	F 3/8"	68,0	M36X200	30	90	400
CS-VD121/2BSPP	1/2"	F 1/2"	65,0	M36X200	30	90	400
CS-VD341/2BSPP	3/4"	F 1/2"	79,4	M42X200	36	148	400
CS-VD343/4BSPP	3/4"	F 3/4"	85,3	M42X200	36	148	400
CS-VD1003/4BSPP	1"	F 3/4"	95,5	M48X300	41	200	300
CS-VD1001BSPP	1"	F 1"	101,0	M48X300	41	200	300
CS-VD1141-1/4BSPP	1"1/4	F 1"1/4	117,2	M70X300	55	378	300
CS-VD1141-1/2BSPP	1"1/4	F 1"1/2	123,2	M70X300	55	378	300

Référence	Corps	F	A	D	H	Débit maxi (l/m)	PN (bar)
<b>BSPP &gt;&gt;&gt;</b>							
CS-VD141/4BSMP	1/4"	F 1/4"	58,5	30,0	19	24	450
CS-VD381/4BSMP	3/8"	F 1/4"	61,5	34,0	22	46	450
CS-VD383/8BSMP	3/8"	F 3/8"	64,5	34,0	22	46	450
CS-VD123/8BSMP	1/2"	F 3/8"	62,3	42,0	30	90	400
CS-VD121/2BSMP	1/2"	F 1/2"	67,3	42,0	30	90	400
CS-VD341/2BSMP	3/4"	F 1/2"	69,9	49,5	36	148	400
CS-VD343/4BSMP	3/4"	F 3/4"	75,8	49,5	36	148	400
CS-VD1003/4BSMP	1"	F 3/4"	79,0	60,0	41	200	300
CS-VD1001BSMP	1"	F 1"	84,5	60,0	41	200	300
CS-VD1141-1/4BSMP	1"1/4	F 1"1/4	121,0	85,0	55	378	300
CS-VD1141-1/2BSMP	1"1/4	F 1"1/2	127,0	85,0	55	378	300

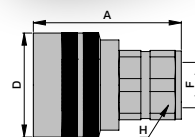
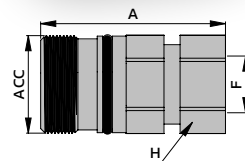

**MATIÈRE**  
Acier - CR3

**JOINT**  
NBR - PTFE

**TEMPÉRATURE DE SERVICE**  
-20 à +100 °C

**INTERCHANGEABLE**  
Selon ISO 14541

**CONNEXION**  
Connectable sous pression :  
Max 100 bar

**CPL A VISSER OIL & GAS / VOF**

Référence	Corps	F	A	ACC	H	Débit maxi (l/m)	PN (bar)
<b>BSPP &gt;&gt;&gt;</b>							
CS-VOF34BSPP	3/4"	F 3/4"	83,2	1"3/4-8 SP	31,8	212	345
CS-VOF100BSPP	1"	F 1"	105,8	2"1/4-6 ACME	41,3	378	345
CS-VOF114BSPP	1"1/4	F 1"1/4	136,7	2"5/8-6 ACME	50,8	576	345
CS-VOF112BSPP	1"1/2	F 1"1/2	151,2	3"1/4-4 ACME	57,2	758	345
CS-VOF200BSPP	2"	F 2"	179,0	4"-4 ACME	76,2	1100	345

Référence	Corps	F	A	D	H	Débit maxi (l/m)	PN (bar)
<b>BSPP &gt;&gt;&gt;</b>							
CS-VOF34BSPM	3/4"	F 3/4"	71,8	53,0	31,8	212	345
CS-VOF100BSPM	1"	F 1"	87,3	69,0	41,3	378	345
CS-VOF114BSPM	1"1/4	F 1"1/4	112,4	80,0	50,8	576	345
CS-VOF112BSPM	1"1/2	F 1"1/2	126,9	95,0	57,2	758	345
CS-VOF200BSPM	2"	F 2"	154,2	122,5	76,2	1100	345

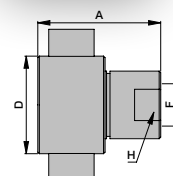
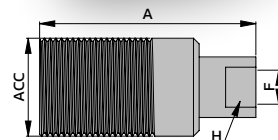

**MATIÈRE**  
Acier - CR3

**JOINT**  
NBR - PTFE

**TEMPÉRATURE DE SERVICE**  
-20 à +100 °C

**CONNEXION**  
Connectable sous pression résiduelle

**CPL A VISSER "ROHRLEITUNG" / VR**

Référence	Corps	F	A	ACC	H	Débit maxi (l/m)	PN (bar)
<b>SERIE L &gt;&gt;&gt;</b>							
CS-VR38L10F	3/8"	10L - M16X150	60,0	32X300 SP	36	46	400
CS-VR38L12F	3/8"	12L - M18X150	60,0	32X300 SP	36	46	400
CS-VR38L15F	3/8"	15L - M22X150	61,0	32X300 SP	36	46	400
CS-VR12PL15F	1/2"	15L - M22X150	70,5	36X300 SP	41	90	300
CS-VR34L15F	3/4"	15L - M22X150	90,1	48X300 SP	50	212	350
CS-VR34L18F	3/4"	18L - M26X150	90,1	48X300 SP	50	212	350
CS-VR100L18F	1"	18L - M26X150	96,2	54X400 SP	60	378	300
CS-VR100L22F	1"	22L - M30X200	98,2	54X400 SP	60	378	300
CS-VR100L28F	1"	28L - M36X200	98,2	54X400 SP	60	378	300
CS-VR114L35F	1 1/4"	35L - M45X200	123,0	79X400 SP	91	576	420

<b>SERIE S &gt;&gt;&gt;</b>							
CS-VR38S10F	3/8"	10S - M18X150	61,0	32X300 SP	36	46	400
CS-VR38S12F	3/8"	12S - M20X150	61,0	32X300 SP	36	46	400
CS-VR38S14F	3/8"	14S - M22X150	63,0	32X300 SP	36	46	400
CS-VR38S16F	3/8"	16S - M24X150	63,0	32X300 SP	36	46	400
CS-VR12PS16F	1/2"	16S - M24X150	72,5	36X300 SP	41	90	300
CS-VR12PS20F	1/2"	20S - M30X200	74,5	36X300 SP	41	90	300
CS-VR34S16F	3/4"	16S - M24X150	92,1	48X300 SP	50	212	350
CS-VR34S20F	3/4"	20S - M30X200	94,1	48X300 SP	50	212	350
CS-VR100S20F	1"	20S - M30X200	100,2	54X400 SP	60	378	300
CS-VR100S25F	1"	25S - M36X200	102,2	54X400 SP	60	378	300
CS-VR100S30F	1"	30S - M42X200	104,2	54X400 SP	60	378	300
CS-VR114S38F	1 1/4"	38S - M52X200	129,0	79X400 SP	91	576	420

Référence	Corps	F	A	ACC	H	Débit maxi (l/m)	PN (bar)
<b>SERIE L &gt;&gt;&gt;</b>							
CS-VR38L10M	3/8"	10L - M16X150	61,6	32X300 SP	22	46	200
CS-VR38L12M	3/8"	12L - M18X150	61,6	32X300 SP	22	46	200
CS-VR38L15M	3/8"	15L - M22X150	62,6	32X300 SP	22	46	200
CS-VR12L15M	1/2"	15L - M22X150	71,6	36X300 SP	24	90	170
CS-VR34L15M	3/4"	15L - M22X150	84,1	48X300 SP	32	212	200
CS-VR34L18M	3/4"	18L - M26X150	84,1	48X300 SP	32	212	200
CS-VR100L18M	1"	18L - M26X150	107,0	54X400 SP	41	378	200
CS-VR100L22M	1"	22L - M30X200	109,0	54X400 SP	41	378	200
CS-VR100L28M	1"	28L - M36X200	109,0	54X400 SP	41	378	200
CS-VR114L35M	1 1/4"	35L - M45X200	130,4	79X400 SP	55	576	420

<b>SERIE S &gt;&gt;&gt;</b>							
CS-VR38S10M	3/8"	10S - M18X150	62,6	32X300 SP	22	46	200
CS-VR38S12M	3/8"	12S - M20X150	62,6	32X300 SP	22	46	200
CS-VR38S14M	3/8"	14S - M22X150	64,6	32X300 SP	22	46	200
CS-VR38S16M	3/8"	16S - M24X150	64,6	32X300 SP	22	46	200
CS-VR12S16M	1/2"	16S - M24X150	73,6	36X300 SP	24	90	170
CS-VR12S20M	1/2"	20S - M30X200	100,8	36X300 SP	32	90	170
CS-VR34S16M	3/4"	16S - M24X150	86,1	48X300 SP	32	212	200
CS-VR34S20M	3/4"	20S - M30X200	88,1	48X300 SP	32	212	200
CS-VR100S20M	1"	20S - M30X200	111,0	54X400 SP	41	378	200
CS-VR100S25M	1"	25S - M36X200	113,0	54X400 SP	41	378	200
CS-VR100S30M	1"	30S - M42X200	115,0	54X400 SP	41	378	200
CS-VR114S38M	1 1/4"	38S - M52X200	136,4	79X400 SP	55	576	420

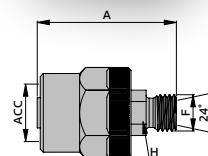
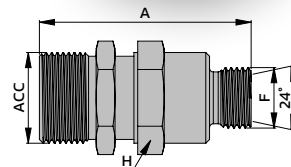
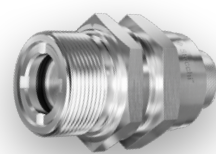

**MATIÈRE**  
Acier - CR3

**JOINT**  
NBR - PTFE

**TEMPÉRATURE DE SERVICE**  
-20 à +100 °C

**CONNEXION**  
Connectable sous pression :  
- Max 100 bar  
- Max 40 bar en DN32

**CPL A VISSER VERIN ISO 14540 / IV-HP**

Référence	Corps	F	A	D	H	Débit maxi (l/m)	PN (bar)
<b>NPTF &gt;&gt;&gt;</b>							
CS-IV14HP1/4NPTEF	1/4"	M 1/4"	60,8	28	22	12	700
CS-IV14HP1/4NPTF	1/4"	F 1/4"	60,8	28	22	12	700
CS-IV38HP1/4NPTEF	3/8"	M 1/4"	72,3	35	24	23	700
CS-IV38HP1/4NPTF	3/8"	F 1/4"	69,9	35	24	23	700
CS-IV38HP3/8NPTEF	3/8"	M 3/8"	72,2	35	24	23	700
CS-IV38HP3/8NPTF	3/8"	F 3/8"	72,3	35	24	23	700

Référence	Corps	F	A	ØAcc	H	Débit maxi (l/m)	PN (bar)
<b>NPTF &gt;&gt;&gt;</b>							
CS-IV14HP1/4NPTM	1/4"	F 1/4"	32,5	15,8	19	12	700
CS-IV38HP1/4NPTM	3/8"	F 1/4"	40,0	19,0	32	23	700
CS-IV38HP3/8NPTM	3/8"	F 3/8"	40,0	19,0	32	23	700

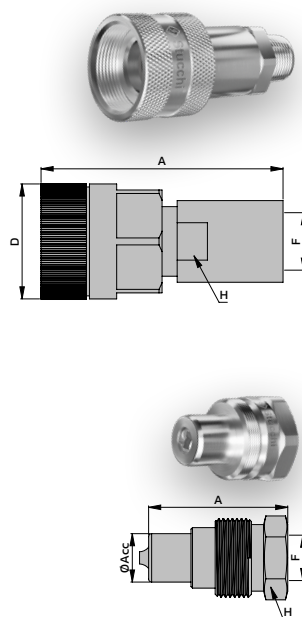

**MATIÈRE**  
Acier - CR3

**JOINT**  
NBR - PTFE

**TEMPÉRATURE DE SERVICE**  
-20 à +100 °C

**ACCESSOIRES POUR COUPLEURS A VISSER / IV-HP**

Référence	Description	Taille	Pour coupleur	Type	Matière	Couleur
CS-BIV14HPM	Bouchon	1/4"	Mâle	IV-HP	PVC	Rouge
CS-BIV38HPM	Bouchon	3/8"	Mâle	IV-HP	PVC	Rouge
CS-BIV14HPF	Bouchon	1/4"	Femelle	IV-HP	PVC	Rouge
CS-BIV38HPF	Bouchon	3/8"	Femelle	IV-HP	PVC	Rouge



## PLATINES STUCCHI

### PLATINE 2 COUPLEURS ANTI-POLLUTION / DP2

Référence	Description	Taille coupleur	Type coupleur	Implantation	A	B	C	D	E	F
<b>DP2 2A-2EC V04 &gt;&gt;&gt;</b>										
CS-DP2-2A-2ECV04	Platine complète	3/8"	FAP9A	G1/2"	80,5	29,3	34,5	125	69	157,2
CS-DP2-2A-2ECV04-F	Platine fixe nue	3/8"	FAP9A	-	80,5	-	34,5	125	69	157,2
CS-DP2-2A-2ECV04-M	Platine mobile nue	3/8"	FAP9A	-	-	29,3	-	125	69	-
<b>DP2 2B-2EC V04 &gt;&gt;&gt;</b>										
CS-DP2-2B-2ECV04	Platine complète	1/2"	FAP13	G1/2"	80,5	33,1	34,5	139	69	171,2
CS-DP2-2B-2ECV04-F	Platine fixe nue	1/2"	FAP13	-	80,5	-	34,5	139	69	171,2
CS-DP2-2B-2ECV04-M	Platine mobile nue	1/2"	FAP13	-	-	33,1	-	139	69	-

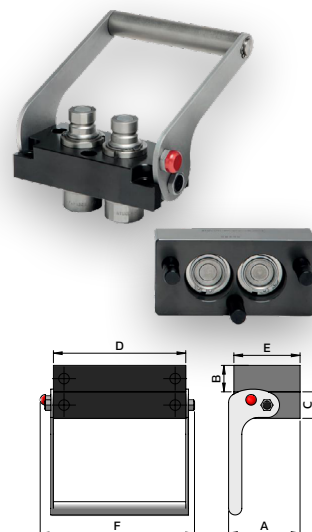

**MATIÈRE**  
Corps Alu  
Lever Acier ZN

**CONNEXION**  
Connectable sous pression  
(voir coupleurs FAP)

Possibilité de remplacer  
un coupleur par une fiche  
électrique

### ACCESSOIRES POUR PLATINE DP2

Référence	Description	Type	Dimensions	Platine
CS-PS125X69-DP	Protection de platine	Mobile	125X69	DP2 2A-2EC V04
CS-CF125X69-DP	Protection de platine	Fixe	125X69	DP2 2A-2EC V04
CS-PS139X69-DP	Protection de platine	Mobile	139X69	DP2 2B-2EC V04
CS-CF139X69-DP	Protection de platine	Fixe	139X69	DP2 2B-2EC V04

## PLATINE 4 COUPLEURS ANTI-POLLUTION / DP4

Référence	Description	Taille coupleur	Type coupleur	A	B	C	D	E	F
<b>DP4 4A-2EC &gt;&gt;&gt;</b>									
<b>CS-DP4-4A-2EC-F</b>	Platine fixe nue	3/8"	FAP9A	140,6	-	34,5	105	94	137,2
<b>CS-DP4-4A-2EC-M</b>	Platine mobile nue	3/8"	FAP9A	-	29,3	-	105	94	-
<b>DP4 4B-2EC &gt;&gt;&gt;</b>									
<b>CS-DP4-4B-2EC-F</b>	Platine fixe nue	1/2"	FAP13	150,6	-	34,5	125	114	157,2
<b>CS-DP4-4B-2EC-M</b>	Platine mobile nue	1/2"	FAP13	-	33,1	-	125	114	-

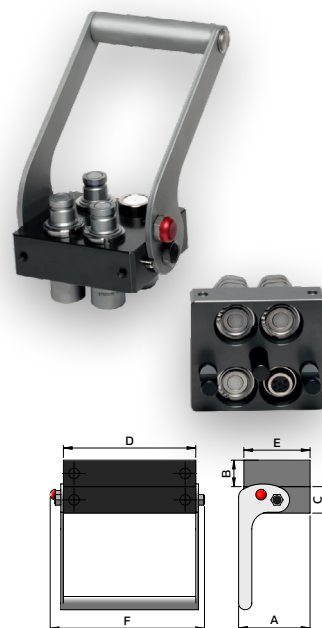

**MATIÈRE**  
Corps Alu  
Lever Acier ZN

**CONNEXION**  
Connectable sous pression  
(voir coupleurs FAP)

Possibilité de remplacer deux coupleurs par des fiches électriques

## ACCESSOIRES POUR PLATINE DP4

Référence	Description	Type	Taille	Platine
<b>CS-PS105X94-DP</b>	Protection de platine	Mobile	105X94	DP4 4A-2EC
<b>CS-CF105X94-DP</b>	Protection de platine	Fixe	105X94	DP4 4A-2EC
<b>CS-PS125X114-DP</b>	Protection de platine	Mobile	125X114	DP4 4B-2EC
<b>CS-CF125X114-DP</b>	Protection de platine	Fixe	125X114	DP4 4B-2EC

## PLATINE 4 COUPLEURS ANTI-POLLUTION / GR4

Référence	Description	Taille coupleur	Type coupleur	Implantation	A	B	C	D	E	F
<b>GR4 2A-2B-2EC &gt;&gt;&gt;</b>										
<b>CS-GR4-2A-2B</b>	Platine complète	2x 3/8 2x 1/2"	FAP9D FAP13	2x G3/8" 2x G1/2"	135,6	32,8	65,3	139	90	175,9
<b>CS-GR4-2A-2B-2EC-F</b>	Platine fixe nue	2x 3/8" 2x 1/2"	FAP9D FAP13	-	135,6	-	65,3	139	90	175,9
<b>CS-GR4-2A-2B-2EC-M</b>	Platine mobile nue	2x 3/8" 2x 1/2"	FAP9D FAP13	-	-	32,8	-	139	90	-

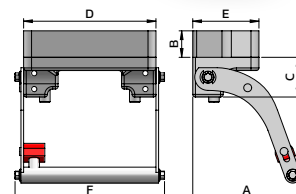
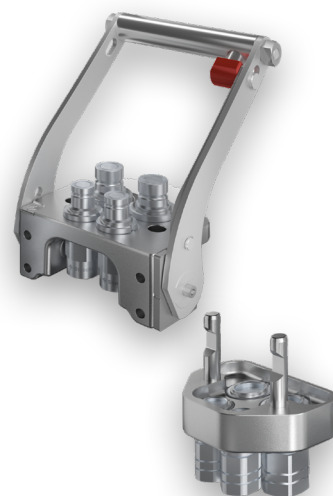

**MATIÈRE**  
Corps Laiton nickelé  
Lever Acier ZN

**CONNEXION**  
Connectable sous pression  
(voir coupleurs FAP)

Possibilité de remplacer  
FAP9D par des fiches  
électriques

## ACCESSOIRES POUR PLATINE GR4

Référence	Description	Type	Dimensions	Platine
<b>CS-PS140X100-GR</b>	Protection de platine	Mobile	140X100	GR4 2A-2B-2EC
<b>CS-CF139X90-GR</b>	Protection de platine	Fixe	139X90	GR4 2A-2B-2EC

## PLATINE 5 COUPLEURS ANTI-POLLUTION / GR5

Référence	Description	Taille coupleur	Type coupleur	A	B	C	D	E	F
<b>GR5 2B-3D-2EC &gt;&gt;&gt;</b>									
<b>CS-GR5 2B-3D-2EC-F</b>	Platine fixe nue	2x 1/2" 3x 3/4"	FAP13 FAP17	157,1	-	70,8	175	118	211,9
<b>CS-GR5 2B-3D-2EC-M</b>	Platine mobile nue	2x 1/2" 3x 3/4"	FAP13 FAP17	-	32,8	-	175	118	-

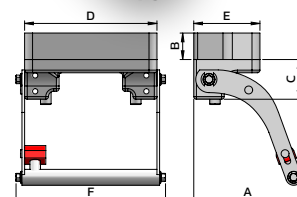
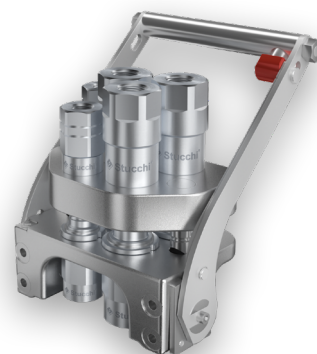

### MATIÈRE

Corps Laiton nickelé  
Lever Acier ZN

### CONNEXION

Connectable sous pression  
(voir coupleurs FAP)

Possibilité de remplacer FAP13  
par des fiches électriques

## ACCESSOIRES POUR PLATINE GR5

Référence	Description	Type	Dimensions	Platine
<b>CS-PS180X120V02-GR</b>	Protection de platine	Mobile	180X120	GR5 2B-3D-2EC
<b>CS-CF175X117V02-GR</b>	Protection de platine	Fixe	175X117	GR5 2B-3D-2EC

**PLATINE 6 COUPLEURS ANTI-POLLUTION / GR6**

Référence	Description	DN coupleur	Type coupleur	Implantation	A	B	C	D	E	F
<b>GR6 6A-2EC &gt;&gt;&gt;</b>										
CS-GR6-6A	Platine complète	3/8"	FAP9A	G3/8"	135,6	29	65,3	139	90	175,6
CS-GR6-6A-2EC-F	Platine fixe nue	3/8"	FAP9A	-	135,6	-	65,3	139	90	175,6
CS-GR6-6A-2EC-M	Platine mobile nue	3/8"	FAP9A	-	-	29	-	139	90	-
<b>GR6 6B-2EC &gt;&gt;&gt;</b>										
CS-GR6-6B-2EC-F	Platine fixe nue	1/2"	FAP13	-	154,6	-	70,8	175	118	211,9
CS-GR6-6B-2EC-M	Platine mobile nue	1/2"	FAP13	-	-	32,8	-	175	118	-
<b>GR6 2A-2B-2C-2EC &gt;&gt;&gt;</b>										
CS-GR6-2ABC-2EC-F	Platine fixe nue	2x 3/8" 2x 1/2" 2x 5/8"	FAP9D FAP13 FAP15	-	157,1	-	70,8	175	118	211,9
CS-GR6-2ABC-2EC-M	Platine mobile nue	2x 3/8" 2x 1/2" 2x 5/8"	FAP9D FAP13 FAP15	-	-	32,8	-	175	118	-

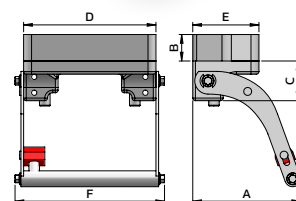
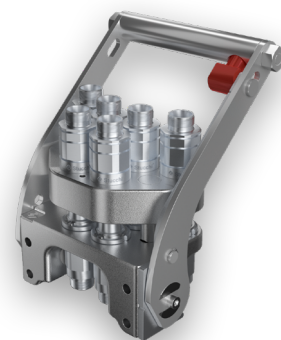

**MATIÈRE**  
 Corps Laiton nickelé  
 Levier Acier ZN

**CONNEXION**  
 Connectable sous pression  
 (voir coupleurs FAP)

Possibilité de remplacer les  
 coupleurs aux extrémités par  
 des fiches électriques

**ACCESSOIRES POUR PLATINE GR6**

Référence	Description	Type	Dimensions	Platine
CS-PS140X100-GR	Protection de platine	Mobile	140X100	GR6 2A-2EC
CS-CF139X90-GR	Protection de platine	Fixe	139X90	GR6 2A-2EC
CS-PS180X120-GR	Protection de platine	Mobile	180X120	GR6 2B-2EC
CS-CF175X117-GR	Protection de platine	Fixe	175X117	GR6 2B-2EC
CS-PS180X120V02-GR	Protection de platine	Mobile	180X120	GR6 2A-2B-2C-2EC
CS-CF175X117V02-GR	Protection de platine	Fixe	175X117	GR6 2A-2B-2C-2EC

**PLATINE 10 COUPLEURS ANTI-POLLUTION / GR10**

Référence	Description	DN coupleur	Type coupleur	Implantation	A	B	C	D	E	F
<b>GR10 10A-2EC &gt;&gt;&gt;</b>										
<b>CS-GR10-10A</b>	Platine complète	3/8"	FAP9D	G3/8"	165,6	32,8	70,8	175	118	211,9
<b>CS-GR10-10A-2EC-F</b>	Platine fixe nue	3/8"	FAP9D	-	165,6	-	70,8	175	118	211,9
<b>CS-GR10-10A-2EC-M</b>	Platine mobile nue	3/8"	FAP9D	-	-	32,8	-	175	118	-
<b>GR10 10B-2EC &gt;&gt;&gt;</b>										
<b>CS-GR10-10B-2EC-F</b>	Platine fixe nue	1/2"	FAP13	-	170,8	-	74,3	218	140,2	255
<b>CS-GR10-10B-2EC-M</b>	Platine mobile nue	1/2"	FAP13	-	-	32,8	-	218	140,2	-

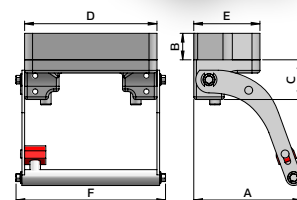
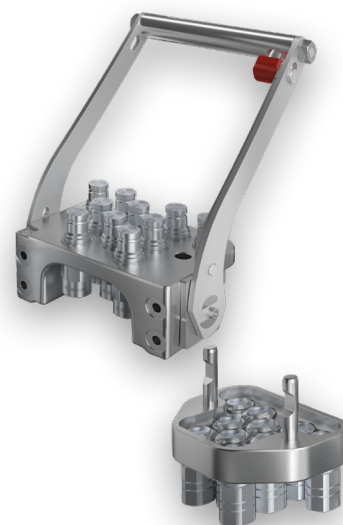
**MATIÈRE**

Corps Laiton nickelé  
 Levier Acier ZN

**CONNEXION**

Connectable sous pression  
 (voir coupleurs FAP)

Possibilité de remplacer les  
 coupleurs aux extrémités par  
 des fiches électriques

**ACCESSOIRES POUR PLATINE GR10**

Référence	Description	Type	Dimensions	Platine
<b>CS-PS180X120-GR</b>	Protection de platine	Mobile	180X120	GR10 2A-2EC
<b>CS-CF175X117-GR</b>	Protection de platine	Fixe	175X117	GR10 2A-2EC
<b>CS-PS218X150-GR</b>	Protection de platine	Mobile	218X150	GR10 2B-2EC
<b>CS-CF218X140-GR</b>	Protection de platine	Fixe	218X140	GR10 2B-2EC

**CPL PLATINE ANTI-POLLUTION CSP / FEMELLE FAP**

Référence	Corps	F	H	Débit maxi (l/m)	PN (bar)
<b>BSPP &gt;&gt;&gt;</b>					
CS-FAP9A04BSP-MO	3/8" A	1/4"	30	46	350
CS-FAP9D04BSP-MO	3/8" D	1/4"	30	46	350
CS-FAP9A06BSP-MO	3/8" A	3/8"	30	46	350
CS-FAP9D06BSP-MO	3/8" D	3/8"	30	46	350
CS-FAP9A08BSP-MO	3/8" A	1/2"	30	46	350
CS-FAP9D08BSP-MO	3/8" D	1/2"	30	46	350
CS-FAP1308BSP-MO	1/2"	1/2"	36	90	330
CS-FAP1312BSP-MO	1/2"	3/4"	36	90	330
CS-FAP1512BSP-MO	5/8"	3/4"	41	148	330
CS-FAP1712BSP-MO	3/4"	3/4"	46	200	330
CS-FAP1716BSP-MO	3/4"	1"	46	200	330
CS-FAP2116BSP-MO	1"	1"	55	378	300
CS-FAP2120BSP-MO	1"	1 1/4"	55	378	300
<b>SAE &gt;&gt;&gt;</b>					
CS-FAP9A04SAE-MO	3/8" A	7/16" UNF	27	46	350
CS-FAP9D04SAE-MO	3/8" D	7/16" UNF	27	46	350
CS-FAP9A06SAE-MO	3/8" A	9/16" UNF	27	46	350
CS-FAP9D06SAE-MO	3/8" D	9/16" UNF	27	46	350
CS-FAP9A08SAE-MO	3/8" A	3/4" UNF	27	46	350
CS-FAP9D08SAE-MO	3/8" D	3/4" UNF	27	46	350
CS-FAP9A10SAE-MO	3/8" A	7/8" UNF	27	46	350
CS-FAP9D10SAE-MO	3/8" D	7/8" UNF	27	46	350
CS-FAP1308SAE-MO	1/2"	3/4" UNF	36	90	330
CS-FAP1310SAE-MO	1/2"	7/8" UNF	36	90	330
CS-FAP1312SAE-MO	1/2"	1 1/16 UN	36	90	330
CS-FAP1512SAE-MO	5/8"	1 1/16 UN	41	148	330
CS-FAP1712SAE-MO	3/4"	1 1/16 UN	46	200	330
CS-FAP1716SAE-MO	3/4"	1 5/16 UN	46	200	330
CS-FAP2116SAE-MO	1"	1 5/16 UN	55	378	300
CS-FAP2120SAE-MO	1"	1 5/8 UN	55	378	300



**MATIÈRE**  
Acier - ZN

**JOINTS**  
NBR - PTFE

**TEMPÉRATURE DE SERVICE**  
-20 à +100 °C

Série	Corps	CSP pression maxi (bar)		DSP pression maxi (bar)
		Femelle seule	Male & femelle	
FAP9 A/D	3/8"	250	250	250
FAP13	1/2"	250	200	200
FAP15	5/8"	250	200	200
FAP17	3/4"	250	150	150
FAP21	1"	250	150	150

**CPL PLATINE ANTI-POLLUTION CSP / MALE FAP**

Référence	Corps	F	H	Débit maxi (l/m)	PN (bar)
<b>BSPP &gt;&gt;&gt;</b>					
CS-FAP9A04BSP-FI	3/8" A	1/4"	27	46	350
CS-FAP9D04BSP-FI	3/8" D	1/4"	27	46	350
CS-FAP9A06BSP-FI	3/8" A	3/8"	27	46	350
CS-FAP9D06BSP-FI	3/8" D	3/8"	27	46	350
CS-FAP9A08BSP-FI	3/8" A	1/2"	27	46	350
CS-FAP9D08BSP-FI	3/8" D	1/2"	27	46	350
CS-FAP1308BSP-FI	1/2"	1/2"	36	90	330
CS-FAP1312BSP-FI	1/2"	3/4"	36	90	330
CS-FAP1512BSP-FI	5/8"	3/4"	36	148	330
CS-FAP1712BSP-FI	3/4"	3/4"	46	200	330
CS-FAP1716BSP-FI	3/4"	1"	46	200	330
CS-FAP2116BSP-FI	1"	1"	55	378	300
CS-FAP2120BSP-FI	1"	1 1/4"	55	378	300
<b>SAE &gt;&gt;&gt;</b>					
CS-FAP9A04SAE-FI	3/8" A	7/16" UNF	30	46	350
CS-FAP9D04SAE-FI	3/8" D	7/16" UNF	30	46	350
CS-FAP9A06SAE-FI	3/8" A	9/16" UNF	30	46	350
CS-FAP9D06SAE-FI	3/8" D	9/16" UNF	30	46	350
CS-FAP9A08SAE-FI	3/8" A	3/4" UNF	30	46	350
CS-FAP9D08SAE-FI	3/8" D	3/4" UNF	30	46	350
CS-FAP9A10SAE-FI	3/8" A	7/8" UNF	30	46	350
CS-FAP9D10SAE-FI	3/8" D	7/8" UNF	30	46	350
CS-FAP1308SAE-FI	1/2"	3/4" UNF	36	90	330
CS-FAP1310SAE-FI	1/2"	7/8" UNF	36	90	330
CS-FAP1312SAE-FI	1/2"	1 1/16 UN	36	90	330
CS-FAP1512SAE-FI	5/8"	1 1/16 UN	36	148	330
CS-FAP1712SAE-FI	3/4"	1 1/16 UN	46	200	330
CS-FAP1716SAE-FI	3/4"	1 5/16 UN	46	200	330
CS-FAP2116SAE-FI	1"	1 5/16 UN	55	378	300
CS-FAP2120SAE-FI	1"	1 5/8 UN	55	378	300



**MATIÈRE**  
Acier - ZN

**JOINTS**  
NBR - PTFE

**TEMPÉRATURE DE SERVICE**  
-20 à +100 °C

Série	Corps	CSP pression maxi (bar)		DSP pression maxi (bar)
		Male seul	Male & femelle	
FAP9 A/D	3/8"	250	250	250
FAP13	1/2"	250	200	200
FAP15	5/8"	250	200	200
FAP17	3/4"	250	150	150
FAP21	1"	250	150	150

**FICHE ELECTRIQUE / EC**

Référence	Corps	Nb de fiches	Platine	Emplacement
CS-EC6-9M-DP	3/8"	6	DP	FAP9A
CS-EC6-9M-GR	3/8"	6	GR	FAP9A
CS-EC6-9M-GRS	3/8"	6	GR	FAP9D
CS-EC6-13M-DP	1/2"	6	DP	FAP13
CS-EC6-13M-GR	1/2"	6	GR	FAP13

Référence	Corps	F	H	H
CS-EC6-9F	3/8"	6	DP / GR	FAP9 A/D
CS-EC6-13F	1/2"	6	DP / GR	FAP13

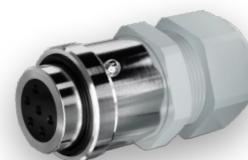

**MATIÈRE**  
Corps Laiton nickelé  
Presse étoupe Plastique

**JOINT**  
NBR

**TENSION MAXIMALE**  
24V

**COURANT NOMINAL**  
12A



## DMH, FOURNISSEUR DE CONNECTIQUE HYDRAULIQUE

Chez DMH France, nous nous engageons à fournir à nos clients les solutions les plus adaptées à leur besoin, grâce à un service efficace et dans les meilleurs délais.

Pour cela, nous avons développé la marque LK Fluid, une gamme complète de connecteurs hydraulique de haute qualité.

Les produits LK Fluid bénéficient d'une capacité de stockage de plus de 5000 m<sup>2</sup>, permettant une forte disponibilité et de faibles délais de livraison.

Ciblant principalement le marché européen, DMH fournit les grands constructeurs ainsi que les spécialistes de la distribution (machines agricoles, poids lourds, industries, etc.).

Nos 20 années d'expérience nous ont permis de construire de forts partenariats avec nos clients, les accompagnant dans leur poursuite d'excellence.

### UNE GAMME COMPLETE DE PRODUITS HYDRAULIQUES



#### DMH ■ Agence de Nantes

6 rue Jupiter 44470 Carquefou FRANCE  
T +33 (0)2 40 25 77 27  
distribution@dmhfrance.com  
oem@dmhfrance.com

#### DMH ■ Agence de Lyon

5 av. Lionel Terray 69330 Meyzieu FRANCE  
T +33 (0)4 37 25 84 50  
infolyon@dmhfrance.com

[www.dmhfrance.com](http://www.dmhfrance.com)



DMH France certifiée ISO 9001:2015

