

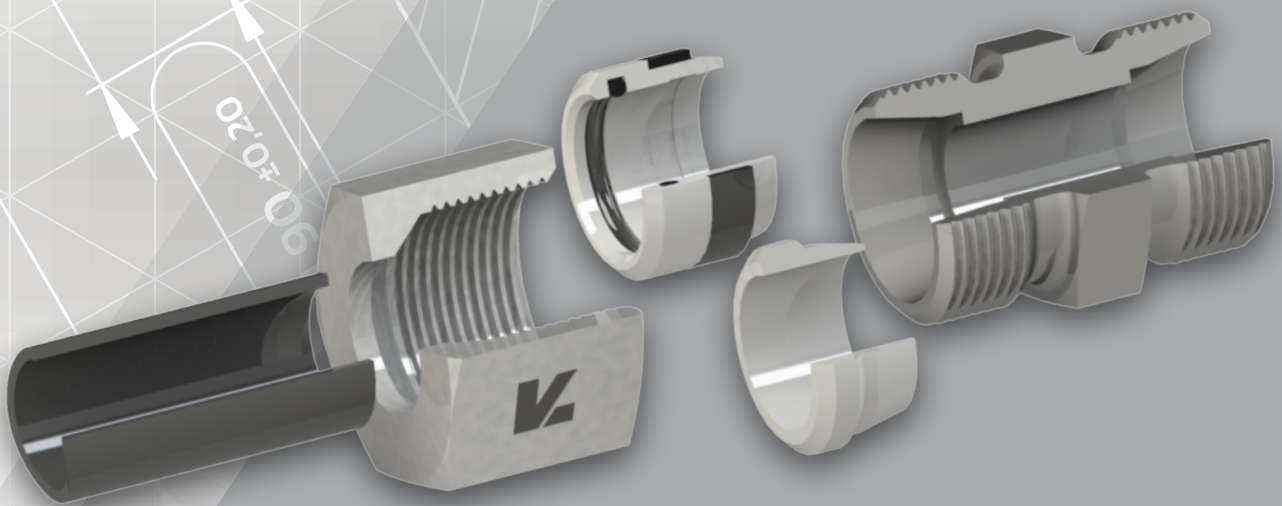

DMH

L K F l u i d













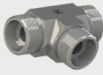









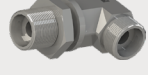

DIN

RACCORDS

www.dmhfrance.com

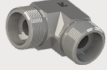
SOMMAIRE

	REFERENCE	PAGE		REFERENCE	PAGE
	SOMMAIRE	DIN 2		COUDE EGAL COMPLET / SERIE LL	DIN 18
	CARACTERISTIQUES TECHNIQUES - DIN 24°	DIN 5		COUDE 45° EGAL	DIN 18
	ECROUS TOURNANTS DIN 24° (ISO 8434-1)	DIN 6		TE EGAL	DIN 19
	PRINCIPE DE FONCTIONNEMENT DES BAGUES COUPANTES (ISO 8434-1 / DIN 2353)	DIN 6		TE EGAL COMPLET / SERIE LL	DIN 19
	NOTICE D'ASSEMBLAGE	DIN 7		TE INEGAL	DIN 20
	CARACTERISTIQUES IMPLANTATIONS	DIN 8		CROIX EGALE	DIN 21
	CARACTERISTIQUES IMPLANTATIONS - COUPLE DE SERRAGE (N/M)	DIN 10		CROIX EGALE COMPLETE / SERIE LL	DIN 21
	LES RACCORDS SPECIFIQUES	DIN 12		UNION DOUBLE PASSE-CLOISON	DIN 22
	ECROU	DIN 13		COUDE EGAL PASSE-CLOISON	DIN 22
	BAGUE COUPANTE	DIN 14		CONTRE-ECROU	DIN 23
	BAGUE A JOINT	DIN 15		COUDE ORIENTABLE DKO	DIN 24
	BAGUE AVEC JOINT HO2	DIN 15		COUDE 45° ORIENTABLE DKO	DIN 24
	UNION DOUBLE	DIN 16		TE ORIENTABLE DKO	DIN 25
	UNION DOUBLE COMPLETE / SERIE LL	DIN 16		TE ORIENTABLE RENVERSE DKO	DIN 25
	UNION DOUBLE REDUITE	DIN 17		UNION FEMELLE / FEMELLE DKO	DIN 26
	UNION DOUBLE REDUITE COMPLETE / SERIE LL	DIN 17		UNION FEMELLE SERIE L / FEMELLE BSPP FIXE	DIN 26
	COUDE EGAL	DIN 18		ADAPTEUR DE REDUCTION DKO / SERIE L	DIN 27

REFERENCE	PAGE	REFERENCE	PAGE
 ADAPTATEUR EGAL DKO / SERIE L	DIN 27	 UNION MALE BSPT COMPLETE / SERIE LL	DIN 37
 ADAPTATEUR DE REDUCTION DKO / SERIE S	DIN 28	 ADAPTATEUR TOURNANT DKO / BSPT	DIN 38
 ADAPTATEUR EGAL DKO / SERIE S	DIN 28	 COUDE MALE BSPT	DIN 39
 UNION MALE BSPP JE / SERIE L	DIN 29	 COUDE MALE BSPT COMPLET / SERIE LL	DIN 39
 UNION MALE BSPP JE COMPLETE / SERIE LL	DIN 29	 TE MALE BSPT	DIN 40
 UNION MALE BSPP JE ROTATIVE / SERIE L	DIN 30	 TE RENVERSE MALE BSPT	DIN 40
 UNION MALE BSPP JE / SERIE S	DIN 31	 UNION MALE METRIQUE JE	DIN 41
 UNION MALE PASSE-CLOISON BSPP JE	DIN 32	 UNION MALE METRIQUE JE COMPLETE / SERIE LL	DIN 42
 ADAPTATEUR TOURNANT DKO / BSPP JE	DIN 33	 ADAPTATEUR TOURNANT DKO / METRIQUE JE	DIN 43
 COUDE ORIENTABLE MALE BSPP	DIN 34	 BANJO METRIQUE JE	DIN 43
 COUDE 45° ORIENTABLE MALE BSPP	DIN 34	 COUDE ORIENTABLE MALE METRIQUE DIN	DIN 44
 TE ORIENTABLE MALE BSPP	DIN 35	 COUDE 45° ORIENTABLE MALE METRIQUE DIN	DIN 44
 TE ORIENTABLE RENVERSE MALE BSPP	DIN 35	 TE ORIENTABLE MALE METRIQUE DIN	DIN 45
 BANJO BSPP JE	DIN 36	 TE ORIENTABLE RENVERSE MALE METRIQUE DIN	DIN 45
 BANJO BSPP JE COMPLET / SERIE LL	DIN 36	 UNION MALE METRIQUE ISO	DIN 46
 BANJO DOUBLE BSPP JE	DIN 36	 COUDE ORIENTABLE MALE METRIQUE ISO	DIN 47
 UNION MALE BSPT	DIN 37	 COUDE 45° ORIENTABLE MALE METRIQUE ISO	DIN 48

	REFERENCE	PAGE		REFERENCE	PAGE
	TE ORIENTABLE MALE METRIQUE ISO	DIN 49		BOUCHON MALE BSPP JE	DIN 56
	TE ORIENTABLE RENVERSE MALE METRIQUE ISO	DIN 49		BOUCHON MALE METRIQUE JE	DIN 56
	UNION MALE METRIQUE CONIQUE	DIN 50		BOUCHON MALE METRIQUE ISO	DIN 57
	UNION MALE METRIQUE CONIQUE COMPLETE / SERIE LL	DIN 50		BOUCHON MALE SAE	DIN 57
	COUDE MALE METRIQUE CONIQUE	DIN 50		UNION MALE VALVE AGRICOLE	DIN 57
	COUDE MALE METRIQUE CONIQUE COMPLET / SERIE LL	DIN 50		EMBOUT A SOUDER	DIN 58
	UNION MALE SAE	DIN 51		UNION SIMPLE A SOUDER	DIN 58
	COUDE MALE ORIENTABLE SAE	DIN 52		UNION DOUBLE A SOUDER	DIN 59
	TE MALE ORIENTABLE SAE	DIN 52		COUDE MALE A SOUDER	DIN 59
	TE MALE ORIENTABLE RENVERSE SAE	DIN 52		REDUCTION MALE / FEMELLE JE	DIN 60
	UNION MALE NPT	DIN 53		UNION FEMELLE BSPP	DIN 61
	UNION MALE NPT COMPLETE / SERIE LL	DIN 53		UNION FEMELLE BSPP MANO	DIN 62
	COUDE MALE NPT	DIN 54		ADAPTATEUR TOURNANT DKO / BSPP MANO	DIN 62
	COUDE MALE NPT COMPLET / SERIE LL	DIN 54		BAGUE D'ETANCHEITE POUR MANOMETRE	DIN 62
	ADAPTATEUR TOURNANT DKO / NPT	DIN 54		BLOC DE PRE-SERTISSAGE	DIN 63
	BOUCHON FEMELLE DIN 24°	DIN 55			
	BOUCHON MALE DIN 24°	DIN 55			

CARACTERISTIQUES TECHNIQUES - DIN 24°

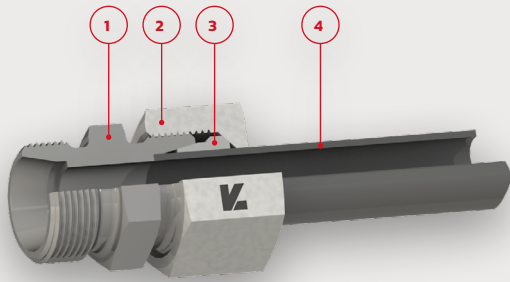

- 1 - RACCORD SERIE DIN L OU S
- 2 - EROU SERIE DIN L OU S
- 3 - BAGUE SERIE DIN L OU S
- 4 - TUBE HYDRAULIQUE SERIE DIN

MALE CONE 24° SERIE LL/L/S (ISO 8434-1)

Ø Tube (mm)	F	D2	D1	L1	L2	PN (Bar)
04-LL	M8X100	4	3,0	8	4,0	100
06-LL	M10X100	6	4,5	8	5,5	100
08-LL	M12X100	8	6,0	9	5,5	100
10-LL	M14X100	10	8,0	9	5,5	100
12-LL	M16X100	12	10,0	9	6,0	100
06-L	M12X150	6	4,0	10	7,0	500
08-L	M14X150	8	6,0	10	7,0	500
10-L	M16X150	10	8,0	11	7,0	500
12-L	M18X150	12	10,0	11	7,0	400
15-L	M22X150	15	12,0	12	7,0	400
18-L	M26X150	18	15,0	12	7,5	400
22-L	M30X200	22	19,0	14	7,5	250
28-L	M36X200	28	24,0	14	7,5	250
35-L	M45X200	35	30,0	16	10,5	250
42-L	M52X200	42	36,0	16	11,0	250
06-S	M14X150	6	4,0	12	7,0	800
08-S	M16X150	8	5,0	12	7,0	800
10-S	M18X150	10	7,0	12	7,5	800
12-S	M20X150	12	8,0	12	7,5	630
14-S	M22X150	14	10,0	14	8,0	630
16-S	M24X150	16	12,0	14	8,5	630
20-S	M30X200	20	16,0	16	10,5	420
25-S	M36X200	25	20,0	18	12,0	420
30-S	M42X200	30	25,0	20	13,5	420
38-S	M52X200	38	32,0	22	16,0	420

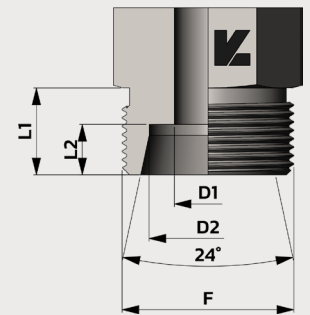

PRESSION DE SERVICE DES RACCORDS DIN 24° - SERIE L / S

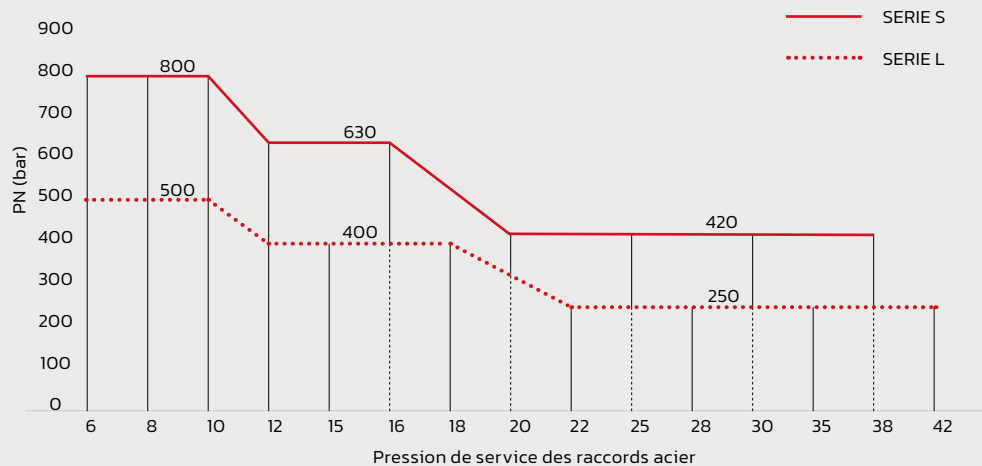

ECROUS TOURNANTS DIN 24° (ISO 8434-1)

Ø Tube (mm)	F	D	Ø Sur filet	H	PN (bar)	O'ring*	Couple (N.m)
06-L	M12X150	6,0	10,50	14	500	4,5X1,5	20
08-L	M14X150	8,0	12,50	17	500	6,5X1,5	25
10-L	M16X150	10,0	14,50	19	500	8X1,5	45
12-L	M18X150	12,0	16,50	22	400	10X1,5	50
15-L	M22X150	15,0	20,50	27	400	12X2,0	60
18-L	M26X150	18,0	24,50	32	400	15X2,0	70
22-L	M30X200	22,0	27,90	36	250	20X2,0	130
28-L	M36X200	28,0	33,90	41	250	26X2,0	180
35-L	M45X200	35,0	42,90	50	250	32X2,5	300
42-L	M52X200	42,0	49,90	60	250	38X2,5	320
06-S	M14X150	6,0	12,50	17	800	4,5X1,5	20
08-S	M16X150	8,0	14,50	19	800	6,5X1,5	35
10-S	M18X150	10,0	16,50	22	800	8X1,5	50
12-S	M20X150	12,0	18,50	24	630	10X1,5	65
14-S	M22X150	14,0	20,50	27	630	12,5X2,0	70
16-S	M24X150	16,0	22,50	30	630	13X2,0	85
20-S	M30X200	20,0	27,90	36	420	16,3X2,4	135
25-S	M36X200	25,0	33,90	46	420	20,3X2,4	170
30-S	M42X200	30,0	39,90	50	420	25,3X2,4	280
38-S	M52X200	38,0	49,90	60	420	33,3X2,4	320

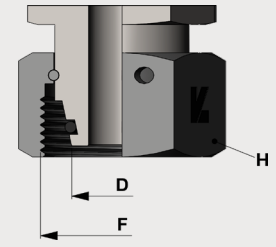

Tolérance couple de serrage : 0/+10%

* Nos raccords DIN sont équipés de joint torique en NBR 90 Shore (autres matières, autres duretés sur demandes)

PRINCIPE DE FONCTIONNEMENT DES BAGUES COUPANTES (ISO 8434-1 / DIN 2353)

AVANT LE SERRAGE

APRES LE SERRAGE

BAGUES COUPANTES

Les bagues coupantes de la gamme LK Fluid sont destinées à être assemblées sur des tubes hydrauliques.

Lors du serrage de l'écrou dans une contrepartie mâle ISO 8434-1/DIN 2353, la bague, de par sa fabrication, se sertit sur le tube en acier et permet d'assurer l'étanchéité de la connexion.

Le raccord peut ensuite être déconnecté et la bague est maintenue en position bien que libre en rotation.

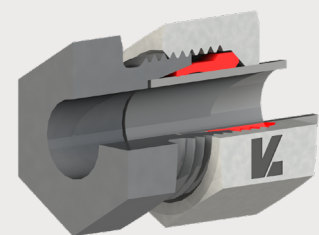
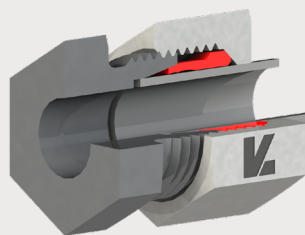

BAGUES À JOINT

Les bagues à joint de la gamme LK Fluid ont un fonctionnement similaire aux bagues coupantes. Elles possèdent néanmoins deux joints élastomères supplémentaires.

Ces joints ont pour fonction d'assurer une étanchéité sans faille, augmentant la durée de vie de votre installation, notamment en présence de vibrations.

La bague à joint est complètement interchangeable avec la bague coupante.

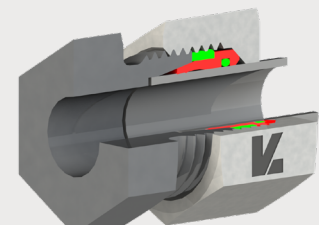
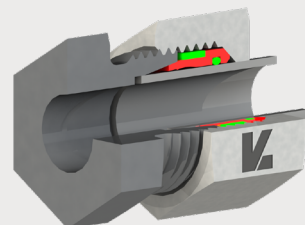

* Voir la **NOTICE D'ASSEMBLAGE** page - DIN 7 -

NOTICE D'ASSEMBLAGE

BAGUE / ÉCROU DIN SUR TUBE HYDRAULIQUE (SUIVANT ISO 8434-1)

1 PRÉPARATION DU TUBE

Couper le tube perpendiculairement à son axe. Un écart de 0,5° est autorisé.

Assurez vous que le tube ne présente pas de microfissure.

Ebavurer légèrement l'intérieur et l'extérieur du tube de façon à obtenir deux chanfreins de 0,2 mm à 45°.

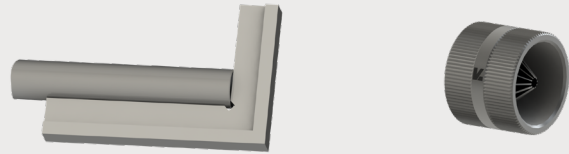

2 MONTAGE DE LA BAGUE ET DE L'ÉCROU SUR LE TUBE

Positionner l'écrou et la bague sur le tube hydraulique. Assurez-vous que le bord de la bague coupante soit orienté vers l'extérieur du tube.

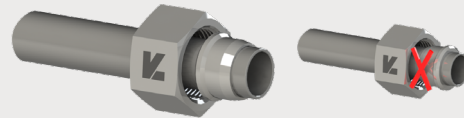

3 PRÉ-ASSEMBLAGE

Lubrifier la bague et les filetages ainsi que le cône 24° du bloc.

Positionner le montage tube / écrou / bague dans le bloc de pré montage, puis serrer l'écrou jusqu'à ce que la bague soit en contact avec le bloc et que l'écrou soit en blocage manuel.

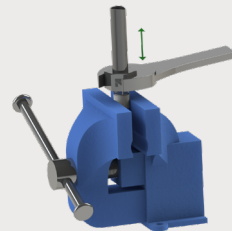

4 PRÉ-SERRAGE

A l'aide d'une clef, appliquer un serrage d'un 1/2 tour.

Vérifier que le tube ne tourne plus. En cas de rotation du tube, appliquer un nouveau serrage d'un nouveau 1/4 de tours.

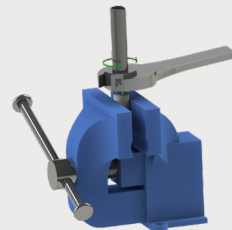

5 CONTRÔLE

Dévisser l'écrou puis vérifier que la bague a déformé le tube (présence d'un refoulement de matière - voir le zoom). La bague peut tourner mais ne doit pas translater sur le tube.

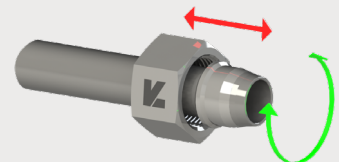

6 MONTAGE FINAL

Visser manuellement la contrepartie sur le tube, puis appliquer :

- 1/2 tour pour la série L
- 3/4 de tour pour la série S

Lors de la première mise en huile, vérifier l'absence de fuite / suintement. Si besoin, procéder à un nouveau serrage de 1/4 tour.

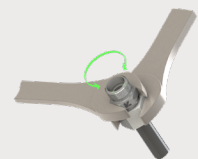

7 NOUVEAU MONTAGE

Chaque fois que le raccord a été desserré, le nouveau montage doit être effectué avec la même procédure.

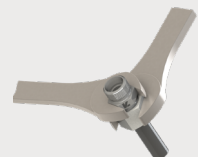

8 MONTAGE AVEC COUDE

Pour le montage de tube coudé, il est recommandé de laisser une partie non cintrée égale à 2 fois la taille de l'écrou.

Un cintrage trop proche de l'arrière de l'écrou pourrait entraîner des fuites voire une éjection de la bague.

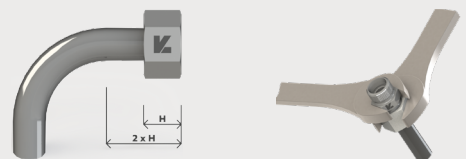

CARACTERISTIQUES IMPLANTATIONS

- Implantation métrique : DIN ISO 6149
- Implantation UNF : SAE J 1926

+ Joint : Joint torique

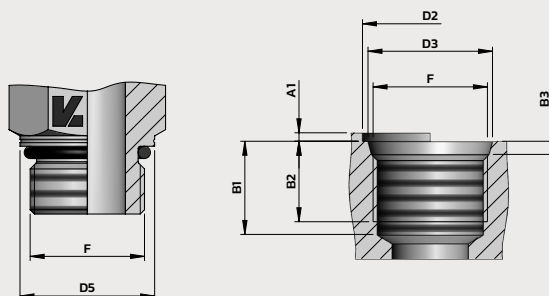

Filetage métrique - DIN ISO 6149

Filetage F	Ø D5	Ø D2* (mm)		Ø D3	A1 maxi (mm)	B1 mini (mm)	B2 mini (mm)	B3 (mm)	Ø sur filet		Joint torique
		sans id.	avec id.						Mâle	Femelle	
M10X100	13,8	16	20	11,10	1,0	11,5	10,0	2,2	9,80	8,92	8,1X1,6
M12X150	16,8	19	23	13,80	1,5	14,0	11,5	2,4	11,80	10,38	9,3X2,2
M14X150	18,8	21	25	15,80	1,5	14,0	11,5	2,4	13,80	12,38	11,3X2,2
M16X150	21,8	24	28	17,80	1,5	15,5	13,0	2,4	15,80	14,38	13,3X2,2
M18X150	23,8	26	30	19,80	2,0	17,0	14,5	2,4	17,80	16,38	15,3X2,2
M20X150	26,8	29	33	21,80	2,0	-	14,5	2,4	19,80	18,38	17,3X2,2
M22X150	26,8	29	33	23,80	2,0	18,0	15,5	2,4	21,80	20,38	19,3X2,2
M27X200	31,8	34	40	29,40	2,0	22,0	19,0	3,1	26,80	24,84	23,6X2,9
M30X200	35,8	38	44	32,40	2,0	22,0	19,0	3,1	29,80	27,84	26,6X2,9
M33X200	40,8	43	49	35,40	2,5	22,0	19,0	3,1	32,80	30,84	29,6X2,9
M42X200	49,8	52	58	44,40	2,5	22,5	19,5	3,1	41,80	39,84	38,6X2,9
M48X200	54,8	57	63	50,40	2,5	25,0	22,0	3,1	47,80	45,84	44,6X2,9
M60X200	64,8	67	74	62,40	2,5	27,5	24,5	3,1	59,80	57,84	56,6X2,9

Filetage UNF - SAE J 1926

Filetage F	Ø D5	Ø D2* (mm)		Ø D3	A1 maxi (mm)	B1 mini (mm)	B2 mini (mm)	B3 (mm)	Ø sur filet		Joint torique
		sans id.	avec id.						Mâle	Femelle	
7/16" UNF	13,8	21	-	12,45	1,6	14,0	11,5	2,4	11,11	9,74	8,92X1,83
1/2" UNF	16,8	23	-	14,05	1,6	14,0	11,5	2,4	12,70	11,30	10,52X1,83
9/16" UNF	16,8	25	-	15,70	1,6	15,5	12,7	2,5	14,29	12,76	11,89X1,98
3/4" UNF	21,8	30	-	20,65	2,4	17,5	14,3	2,5	19,05	17,33	16,36X2,21
7/8" UNF	26,8	34	-	24,00	2,4	20,0	16,7	2,5	22,23	20,26	19,18X2,46
1" 1/16 UN	31,8	41	-	29,20	2,4	23,0	19,0	3,3	26,99	24,69	23,47X2,95
1" 5/16 UN	40,8	49	-	35,55	3,2	23,0	19,0	3,3	33,34	31,04	29,62X2,95
1" 5/8 UN	49,8	58	-	43,55	3,2	23,0	19,0	3,3	41,28	38,99	37,47X3,00
1" 7/8 UN	54,8	65	-	49,90	3,2	23,0	19,0	3,3	47,63	45,33	43,69X3,00

* Valeurs de diamètre avec ou sans arête d'identification

CARACTERISTIQUES IMPLANTATIONS

	Implantation FORME E	Implantation FORME G	Implantation FORME H	Implantation FORME B	Implantation FORME A	Implantation FORME X
Etanchéité	Joint encastré	Joint torique + bague	Joint torique + bague	Métal / Métal sur arête	Divers (BAGUE BS - JC)	-
Norme MET	DIN EN ISO 9974-2	ISO 6149 + bague	ISO 6149 + bague	DIN EN ISO 9974-3	DIN 3852-1	DIN EN ISO 9974-1
Norme BSPP	ISO 1179-2	ISO 1179-3	ISO 1179-3	ISO 1179-4	DIN 3852-2	ISO 1179-1

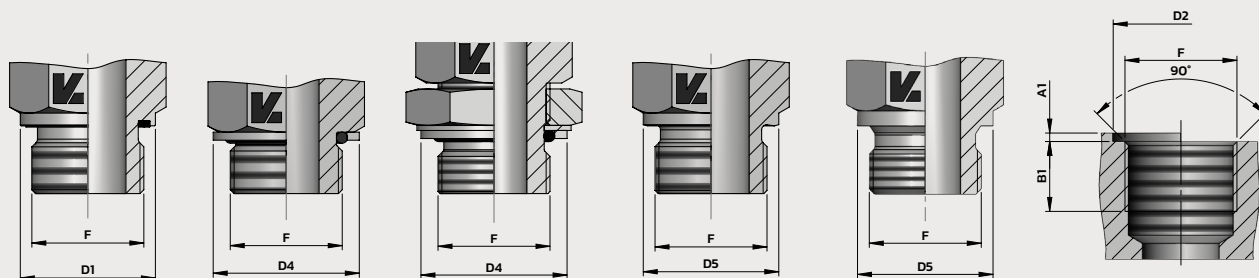

Filetage F	A1 maxi (mm)	B1 mini (mm)	Ø D1 (mm)	Ø D2 mini (mm)	Ø D2 maxi (mm)	Ø D4 (mm)	Ø D5 (mm)
M10X100	1,0	8,0	13,9	15,0	20,0	14,9	13,9
M12X150	1,5	12,0	16,9	18,0	25,0	17,9	16,9
M14X150	1,5	12,0	18,9	20,0	25,0	19,9	18,9
M16X150	1,5	12,0	21,9	23,0	28,0	22,9	20,9
M18X150	2,0	12,0	23,9	25,0	30,0	24,9	22,9
M20X150	2,0	14,0	25,9	27,0	34,0	26,8	24,9
M22X150	2,5	14,0	26,9	28,0	34,0	27,9	26,9
M26X150	2,5	16,0	31,9	33,0	42,0	32,8	30,9
M27X200	2,5	16,0	31,9	33,0	42,0	35,7	31,9
M33X200	2,5	18,0	39,9	41,0	47,0	40,9	38,9
M42X200	2,5	20,0	49,9	51,0	58,0	50,9	48,9
M48X200	2,5	22,0	54,9	56,0	65,0	55,9	54,9
G1/8"	1,0	8,0	13,9	15,0	19,0	15,0	13,8
G1/4"	1,5	12,0	18,9	20,0	25,0	19,5	17,8
G3/8"	2,0	12,0	21,9	23,0	28,0	23,5	21,8
G1/2"	2,5	14,0	26,9	28,0	34,0	28,5	25,8
G3/4"	2,5	16,0	31,9	33,0	42,0	34,5	31,8
G1"	2,5	18,0	39,9	41,0	47,0	43,5	38,8
G1"1/4	2,5	20,0	49,9	51,0	58,0	52,5	48,8
G1"1/2	2,5	22,0	54,9	56,0	65,0	60,0	54,8

CARACTERISTIQUES IMPLANTATIONS - COUPLE DE SERRAGE (N.M)

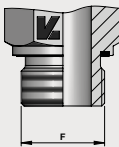
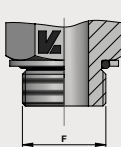
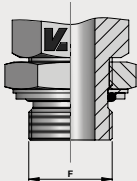
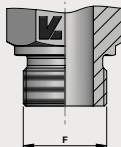
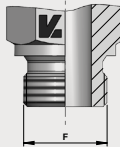
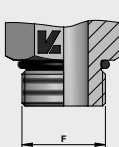
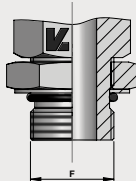
	Implantation E JOINT ENCASTRE	Implantation G JOINT + BAGUE	Implantation orientable H JOINT + BAGUE	Implantation B ARETE SAILLANTE	Implantation A AVEC RONDELLE	Implantation JOINT TORIQUE	Implantation orientable JOINT TORIQUE
							
F	SERIE L						
M10X100	18	18	18	18	9	15	15
M12X150	25	25	25	30	20	25	25
M14X150	45	40	40	45	35	35	35
M16X150	55	55	55	65	45	40	40
M18X150	70	70	70	80	55	45	45
M22X150	125	90	90	140	65	60	60
M26X150	180	180	180	190	90	100	100
M27X200	-	-	-	-	-	100	100
M30X200	-	-	-	-	-	130	130
M33X200	310	310	310	340	150	160	160
M42X200	450	450	450	500	240	210	210
M48X200	540	540	540	630	290	260	260
G1/8"	18	18	18	18	9	-	-
G1/4"	35	35	35	35	35	-	-
G3/8"	70	70	70	70	45	-	-
G1/2"	90	90	110	100-140	65	-	-
G3/4"	180	180	180	180	90	-	-
G1"	310	310	310	330	150	-	-
G1"1/4	450	450	450	540	240	-	-
G1"1/2	540	540	540	630	290	-	-
7/16" UNF	-	-	-	-	-	30	20
1/2" UNF	-	-	-	-	-	35	30
9/16" UNF	-	-	-	-	-	40	40
3/4" UNF	-	-	-	-	-	70	70
7/8" UNF	-	-	-	-	-	115	115
1"1/16 UN	-	-	-	-	-	185	185
1"5/16 UN	-	-	-	-	-	270	270
1"5/8 UN	-	-	-	-	-	340	340
1"7/8 UN	-	-	-	-	-	415	415
F	SERIE S						
M12X150	35	35	35	35	20	35	35
M14X150	45	55	55	55	35	45	45
M16X150	70	70	70	70	45	55	55
M18X150	90	90	90	110	55	70	90
M20X150	125	125	125	150	55	80	-
M22X150	135	135	135	170	65	100	100
M27X200	180	190	190	270	90	170	170
M30X200	-	-	-	-	-	235	235
M33X200	310	310	310	410	150	310	310
M42X200	450	450	450	540	240	330	330
M48X200	540	540	540	700	290	420	420
G1/8"	-	-	-	-	-	-	-
G1/4"	40	40	40	55	35	-	-
G3/8"	80	60	60	90	45	-	-
G1/2"	115	90	90	130-150	65	-	-
G3/4"	180	180	180	270	90	-	-
G1"	310	310	310	340	150	-	-
G1"1/4	450	450	450	540	240	-	-
G1"1/2	540	540	540	700	290	-	-
7/16" UNF	-	-	-	-	-	35	20
1/2" UNF	-	-	-	-	-	40	40
9/16" UNF	-	-	-	-	-	45	45
3/4" UNF	-	-	-	-	-	80	80
7/8" UNF	-	-	-	-	-	135	135
1"1/16 UN	-	-	-	-	-	185	185
1"5/16 UN	-	-	-	-	-	270	270
1"5/8 UN	-	-	-	-	-	340	340
1"7/8 UN	-	-	-	-	-	415	415

Valeur pour filetages lubrifiés

Tolérance couple de serrage : 0 / +10%

Une modification des valeurs doit être étudiée lors d'un assemblage avec une autre matière que l'acier

CARACTERISTIQUES IMPLANTATIONS

Implantation NPT/ NPTF

NPT ANSI / ASME B 1.20.1-1983

NPTF ANSI / ASME B 1.20.3-1976

Implantation FORME C

Métrique DIN 3852-1/2

Implantation BSPT

ISO 7 / BS 21 / DIN 2999-1

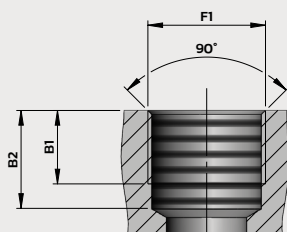
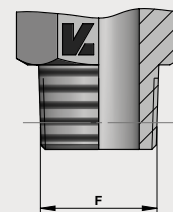
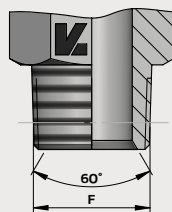
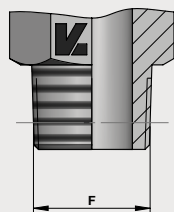

Filetage F	Taroudage F1	B1 mini (mm)	B2 mini (mm)
1/8" NPT	1/8" NPT	6,9	11,6
1/4" NPT	1/4" NPT	10,0	16,4
3/8" NPT	3/8" NPT	10,3	17,4
1/2" NPT	1/2" NPT	13,6	22,6
3/4" NPT	3/4" NPT	14,1	23,1
1" NPT	1" NPT	16,8	27,8
1"1/4 NPT	1"1/4 NPT	17,3	28,3
1"1/2 NPT	1"1/2 NPT	17,3	28,3
R1/8"	G1/8"	7,9	9,7
R1/4"	G1/4"	11,2	12,0
R3/8"	G3/8"	12,0	13,5
R1/2"	G1/2"	15,0	17,6
R3/4"	G3/4"	16,0	19,1
R1"	G1"	19,1	21,4
R1"1/4	G1"1/4	19,9	21,4
R1"1/2	G1"1/2	20,6	22,4
M8X100 CO	M8X100	5,5	10,0
M10X100 CO	M10X100	5,5	10,0
M12X150 CO	M12X150	8,5	13,5
M14X150 CO	M14X150	8,5	13,5
M16X150 CO	M16X150	8,5	13,5
M18X150 CO	M18X150	8,5	13,5
M20X150 CO	M20X150	10,5	15,5
M22X150 CO	M22X150	10,5	15,5

LES RACCORDS SPECIFIQUES

DES SOLUTIONS ADAPTÉES À VOS BESOINS

Dans une industrie en évolution constante, à la recherche de technologie de pointe, un catalogue complet de pièces normalisées et standardisées ne suffit plus pour répondre à un besoin spécifique.

Fort de ses 20 années d'expérience et d'un réseau de partenaires compétents, DMH France est capable de vous proposer des solutions adaptées à vos besoins.

Nos réalisations spéciales à succès comportent notamment :

- **des raccords hydrauliques à encombrement spécifique,**
- **de tailles décalées,**
- **de formes particulières,**
- **à implantations multiples.**

Nous sommes ainsi à votre écoute, pour vous accompagner et vous proposer des solutions pour la réalisation de vos raccords spécifiques.

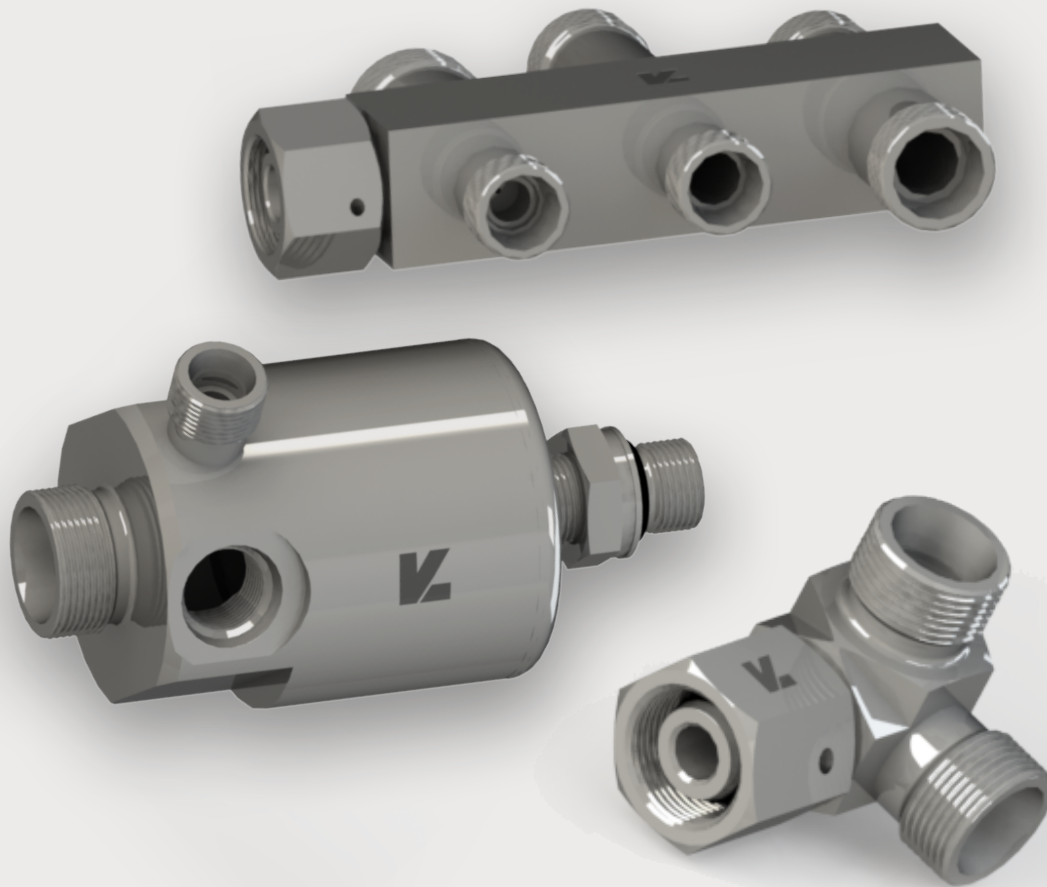
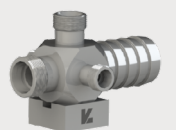
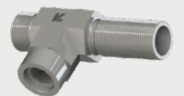
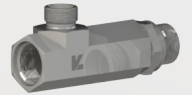
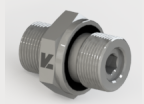

ECROU

Référence	Ø Tube (mm)	F	A	H
DA-EC06L	6L	M12X150	14,5	14
DA-EC08L	8L	M14X150	14,5	17
DA-EC10L	10L	M16X150	15,5	19
DA-EC12L	12L	M18X150	15,5	22
DA-EC15L	15L	M22X150	17,0	27
DA-EC18L	18L	M26X150	18,0	32
DA-EC22L	22L	M30X200	20,0	36
DA-EC28L	28L	M36X200	21,0	41
DA-EC35L	35L	M45X200	24,0	50
DA-EC42L	42L	M52X200	24,0	60
DA-EC06S	6S	M14X150	16,5	17
DA-EC08S	8S	M16X150	16,5	19
DA-EC10S	10S	M18X150	17,5	22
DA-EC12S	12S	M20X150	17,5	24
DA-EC14S	14S	M22X150	20,5	27
DA-EC16S	16S	M24X150	20,5	30
DA-EC20S	20S	M30X200	24,0	36
DA-EC25S	25S	M36X200	27,0	46
DA-EC30S	30S	M42X200	29,0	50
DA-EC38S	38S	M52X200	32,5	60
DA-EC04LL-ZN	4LL	M8X100	11,0	10
DA-EC06LL-ZN	6LL	M10X100	11,5	12
DA-EC08LL-ZN	8LL	M12X100	12,0	14
DA-EC10LL-ZN	10LL	M14X100	13,0	17
DA-EC12LL-ZN	12LL	M16X100	13,5	19

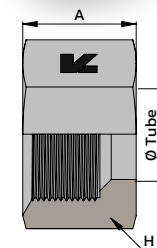
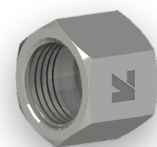

BAGUE COUPANTE

Référence	Ø Tube (mm)	A	PN (bar)
DA-B06L/S	6L	9,5	315
DA-B08L/S	8L	9,5	315
DA-B10L/S	10L	10,0	315
DA-B12L/S	12L	10,0	315
DA-B15L	15L	10,0	315
DA-B18L	18L	10,0	315
DA-B22L	22L	10,5	160
DA-B28L	28L	11,0	160
DA-B35L	35L	13,0	160
DA-B42L	42L	13,0	160
DA-B06L/S	6S	9,5	630
DA-B08L/S	8S	9,5	630
DA-B10L/S	10S	10,0	630
DA-B12L/S	12S	10,0	630
DA-B14S	14S	10,0	630
DA-B16S	16S	10,5	400
DA-B20S	20S	12,0	400
DA-B25S	25S	12,0	400
DA-B30S	30S	13,0	400
DA-B38S	38S	13,0	315
DA-B04LL-ZN	4LL	6,0	100
DA-B06LL-ZN	6LL	7,0	100
DA-B08LL-ZN	8LL	7,0	100
DA-B10LL-ZN	10LL	7,0	100
DA-B12LL-ZN	12LL	7,5	100

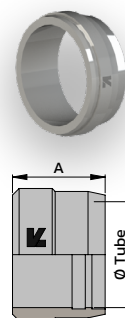

BAGUE A JOINT

Référence	Ø Tube (mm)	A	PN (bar)
DA-B06L/S-JE	6L	9,5	500
DA-B08L/S-JE	8L	9,5	500
DA-B10L/S-JE	10L	10,0	500
DA-B12L/S-JE	12L	10,0	400
DA-B15L-JE	15L	10,0	400
DA-B18L-JE	18L	10,0	400
DA-B22L-JE	22L	10,5	250
DA-B28L-JE	28L	11,0	250
DA-B35L-JE	35L	13,0	250
DA-B42L-JE	42L	13,0	250
DA-B06L/S-JE	6S	9,5	800
DA-B08L/S-JE	8S	9,5	800
DA-B10L/S-JE	10S	10,0	800
DA-B12L/S-JE	12S	10,0	630
DA-B14S-JE	14S	10,0	630
DA-B16S-JE	16S	10,5	630
DA-B20S-JE	20S	12,0	420
DA-B25S-JE	25S	12,0	420
DA-B30S-JE	30S	13,0	420
DA-B38S-JE	38S	13,0	420

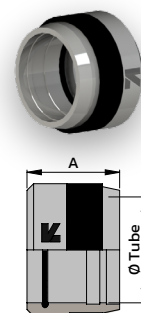

Embouts

Protections

DIN

JIC

ORFS

BSP

GAZ

BAGUE A JOINT H02

Référence	Ø Tube (mm)	PN (bar)
DA-B06L-H2	6L	500
DA-B08L-H2	8L	500
DA-B10L-H2	10L	500
DA-B12L-H2	12L	400
DA-B15L-H2	15L	400
DA-B18L-H2	18L	400
DA-B22L-H2	22L	250
DA-B28L-H2	28L	250
DA-B35L-H2	35L	250
DA-B42L-H2	42L	250
DA-B06S-H2	6S	800
DA-B08S-H2	8S	800
DA-B10S-H2	10S	800
DA-B12S-H2	12S	630
DA-B14S-H2	14S	630
DA-B16S-H2	16S	630
DA-B20S-H2	20S	420
DA-B25S-H2	25S	420
DA-B30S-H2	30S	420
DA-B38S-H2	38S	420



Graissage

Coupleurs

 Vannes
Composants

Brides

 Prises-Pression
Manomètres

Colliers

Joints

Lavage

UNION DOUBLE

Référence	Ø Tube (mm)	F	A	L	H	PN (bar)
DA-UD06L	6L	M12X150	24,0	10,0	12	500
DA-UD08L	8L	M14X150	25,0	11,0	14	500
DA-UD10L	10L	M16X150	27,0	13,0	17	500
DA-UD12L	12L	M18X150	28,0	14,0	19	400
DA-UD15L	15L	M22X150	30,0	16,0	24	400
DA-UD18L	18L	M26X150	31,0	16,0	27	400
DA-UD22L	22L	M30X200	35,0	20,0	32	250
DA-UD28L	28L	M36X200	36,0	21,0	41	250
DA-UD35L	35L	M45X200	41,0	20,0	46	250
DA-UD42L	42L	M52X200	43,0	21,0	55	250
DA-UD06S	6S	M14X150	30,0	16,0	14	800
DA-UD08S	8S	M16X150	32,0	18,0	17	800
DA-UD10S	10S	M18X150	32,0	17,0	19	800
DA-UD12S	12S	M20X150	34,0	19,0	22	630
DA-UD14S	14S	M22X150	38,0	22,0	24	630
DA-UD16S	16S	M24X150	38,0	21,0	27	630
DA-UD20S	20S	M30X200	44,0	23,0	32	420
DA-UD25S	25S	M36X200	50,0	26,0	41	420
DA-UD30S	30S	M42X200	54,0	27,0	46	420
DA-UD38S	38S	M52X200	61,0	29,0	55	420

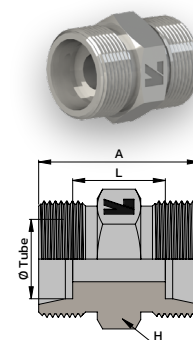
UNION DOUBLE COMPLETE / SERIE LL

Référence	Ø Tube (mm)	F	A	L	H	PN (bar)
DA-UDO4LLC-ZN	4LL	M8X100	20,0	12,0	9	100
DA-UDO6LLC-ZN	6LL	M10X100	21,0	9,0	11	100
DA-UDO8LLC-ZN	8LL	M12X100	23,0	12,0	12	100
DA-UD10LLC-ZN	10LL	M14X100	23,0	12,0	14	100
DA-UD12LLC-ZN	12LL	M16X100	23,0	11,0	17	100

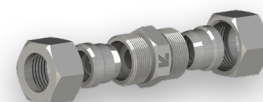

UNION DOUBLE REDUITE



Référence	Ø Tube (mm)	F1	F2	A	L	H	PN (bar)
DA-UDR08/06L	08L / 06L	M14X150	M12X150	25,0	11,0	14	500
DA-UDR10/06L	10L / 06L	M16X150	M12X150	26,0	12,0	17	500
DA-UDR10/08L	10L / 08L	M16X150	M14X150	26,0	12,0	17	500
DA-UDR12/06L	12L / 06L	M18X150	M12X150	27,0	13,0	19	400
DA-UDR12/08L	12L / 08L	M18X150	M14X150	27,0	13,0	19	400
DA-UDR12/10L	12L / 10L	M18X150	M16X150	28,0	14,0	19	400
DA-UDR15/10L	15L / 10L	M22X150	M16X150	29,0	15,0	24	400
DA-UDR15/12L	15L / 12L	M22X150	M18X150	29,0	15,0	24	400
DA-UDR18/10L	18L / 10L	M26X150	M16X150	30,0	15,5	27	400
DA-UDR18/12L	18L / 12L	M26X150	M18X150	30,0	15,5	27	400
DA-UDR18/15L	18L / 15L	M26X150	M22X150	31,0	16,5	27	400
DA-UDR22/12L	22L / 12L	M30X200	M18X150	32,0	17,5	32	250
DA-UDR22/15L	22L / 15L	M30X200	M22X150	33,0	18,5	32	250
DA-UDR22/18L	22L / 18L	M30X200	M26X150	33,0	18,0	32	250
DA-UDR28/18L	28L / 18L	M36X200	M26X150	34,0	19,0	41	250
DA-UDR28/22L	28L / 22L	M36X200	M30X200	36,0	21,0	41	250
DA-UDR35/22L	35L / 22L	M45X200	M30X200	39,0	21,0	46	250
DA-UDR35/28L	35L / 28L	M45X200	M36X200	39,0	21,0	46	250
DA-UDR42/35L	42L / 35L	M52X200	M45X200	43,0	21,5	55	250

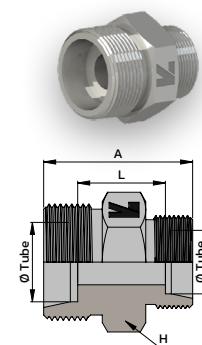

DA-UDR08/06S	08S / 06S	M16X150	M14X150	32,0	18,0	17	800
DA-UDR10/06S	10S / 06S	M18X150	M14X150	32,0	17,5	19	800
DA-UDR10/08S	10S / 08S	M18X150	M16X150	32,0	17,5	19	800
DA-UDR12/06S	12S / 06S	M20X150	M14X150	34,0	19,5	22	630
DA-UDR12/08S	12S / 08S	M20X150	M16X150	34,0	19,5	22	630
DA-UDR12/10S	12S / 10S	M20X150	M18X150	34,0	19,0	22	630
DA-UDR14/10S	14S / 10S	M22X150	M18X150	36,0	20,5	24	630
DA-UDR14/12S	14S / 12S	M22X150	M20X150	36,0	20,5	24	630
DA-UDR16/10S	16S / 10S	M24X150	M18X150	36,0	20,0	27	630
DA-UDR16/12S	16S / 12S	M24X150	M20X150	36,0	20,0	27	630
DA-UDR16/14S	16S / 14S	M24X150	M22X150	36,0	21,5	27	630
DA-UDR20/10S	20S / 10S	M30X200	M18X150	40,0	22,0	32	420
DA-UDR20/12S	20S / 12S	M30X200	M20X150	40,0	22,0	32	420
DA-UDR20/16S	20S / 16S	M30X200	M24X200	42,0	23,0	32	420
DA-UDR25/16S	25S / 16S	M36X200	M24X200	46,0	25,5	41	420
DA-UDR25/20S	25S / 20S	M36X200	M30X200	48,0	25,5	41	420
DA-UDR30/20S	30S / 20S	M42X200	M30X200	50,0	26,0	46	420
DA-UDR30/25S	30S / 25S	M42X200	M36X200	52,0	26,5	46	420
DA-UDR38/30S	38S / 30S	M52X200	M42X200	59,0	29,5	55	420
DA-UDR16S/15L	16S / 15L	M24X160	M22X150	32,0	15,0	27	400

UNION DOUBLE REDUITE COMPLET / SERIE LL

Référence	Ø Tube (mm)	F1	F2	A	L	H	PN (bar)
DA-UDR06/04LLC-ZN	06LL / 04LL	M10X100	M8X100	20,0	10,5	11	100
DA-UDR08/04LLC-ZN	08LL / 04LL	M12X100	M8X100	22,0	12,5	12	100
DA-UDR08/06LLC-ZN	08LL / 06LL	M12X100	M10X100	22,0	11,0	12	100
DA-UDR10/08LLC-ZN	10LL / 08LL	M14X100	M12X100	23,0	12,0	15	100

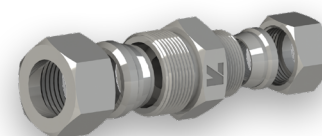

COUDE EGAL

Référence	Ø Tube (mm)	F	A	L	H	PN (bar)
DA-CE06L	6L	M12X150	19,0	12,0	14	500
DA-CE08L	8L	M14X150	21,0	14,0	14	500
DA-CE10L	10L	M16X150	22,0	15,0	17	500
DA-CE12L	12L	M18X150	24,0	17,0	19	400
DA-CE15L	15L	M22X150	28,0	21,0	22	400
DA-CE18L	18L	M26X150	31,0	23,5	24	400
DA-CE22L	22L	M30X200	35,0	27,5	27	250
DA-CE28L	28L	M36X200	38,0	30,5	36	250
DA-CE35L	35L	M45X200	45,0	34,5	41	250
DA-CE42L	42L	M52X200	51,0	38,5	50	250
DA-CE06S	6S	M14X150	23,0	16,0	14	800
DA-CE08S	8S	M16X150	24,0	17,0	17	800
DA-CE10S	10S	M18X150	25,0	17,5	19	800
DA-CE12S	12S	M20X150	29,0	21,5	22	630
DA-CE14S	14S	M22X150	30,0	22,0	19	630
DA-CE16S	16S	M24X150	33,0	24,5	27	630
DA-CE20S	20S	M30X200	37,0	26,5	30	420
DA-CE25S	25S	M36X200	42,0	30,0	36	420
DA-CE30S	30S	M42X200	49,0	35,5	41	420
DA-CE38S	38S	M52X200	57,0	41,0	50	420

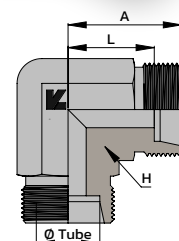
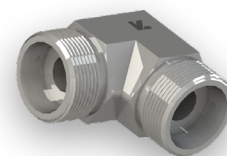

COUDE EGAL COMPLET / SERIE LL

Référence	Ø Tube (mm)	F	A	L	H	PN (bar)
DA-CE04LLC-ZN	4LL	M8X100	15,0	11,0	9	100
DA-CE06LLC-ZN	6LL	M10X100	15,0	9,5	9	100
DA-CE08LLC-ZN	8LL	M12X100	17,0	11,5	12	100
DA-CE10LLC-ZN	10LL	M14X100	17,5	12,5	14	100
DA-CE12LLC-ZN	12LL	M16X100	18,5	12,5	17	100

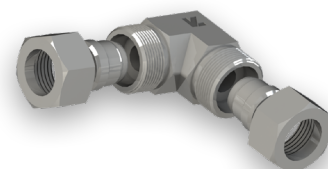

COUDE 45° EGAL



Référence	Ø Tube (mm)	F	A	L	H	PN (bar)
DA-CE4518L	18L	M26X150	31,0	23,5	27	400

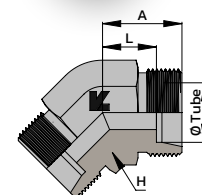
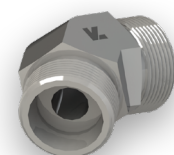

TE EGAL

Référence	Ø Tube (mm)	F	A	L	H	PN (bar)
DA-TE06L	6L	M12X150	19,0	12,0	12	500
DA-TE08L	8L	M14X150	21,0	14,0	14	500
DA-TE10L	10L	M16X150	22,0	15,0	17	500
DA-TE12L	12L	M18X150	24,0	17,0	19	400
DA-TE15L	15L	M22X150	28,0	21,0	22	400
DA-TE18L	18L	M26X150	31,0	23,5	24	400
DA-TE22L	22L	M30X200	35,0	27,5	27	250
DA-TE28L	28L	M36X200	38,0	30,5	36	250
DA-TE35L	35L	M45X200	45,0	34,5	41	250
DA-TE42L	42L	M52X200	51,0	40,0	50	250
DA-TE06S	6S	M14X150	23,0	16,0	14	800
DA-TE08S	8S	M16X150	24,0	17,0	17	800
DA-TE10S	10S	M18X150	25,0	17,5	19	800
DA-TE12S	12S	M20X150	29,0	21,5	22	630
DA-TE14S	14S	M22X150	30,0	22,0	22	630
DA-TE16S	16S	M24X150	33,0	24,5	24	630
DA-TE20S	20S	M30X200	37,0	26,5	30	420
DA-TE25S	25S	M36X200	42,0	30,0	36	420
DA-TE30S	30S	M42X200	49,0	35,5	41	420
DA-TE38S	38S	M52X200	57,0	41,0	50	420

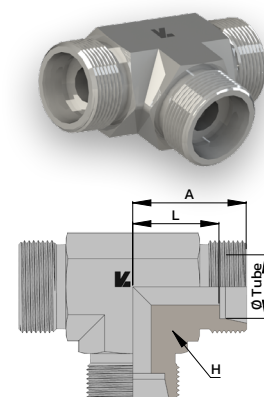

Embout

Protections

DIN

JIC

ORFS

BSP

GAZ

TE EGAL COMPLET / SERIE LL

Référence	Ø Tube (mm)	F	A	L	H	PN (bar)
DA-TE04LLC-ZN	4LL	M8X100	15,0	11,0	9	100
DA-TE06LLC-ZN	6LL	M10X100	15,0	9,5	9	100
DA-TE08LLC-ZN	8LL	M12X100	17,0	11,5	12	100
DA-TE10LLC-ZN	10LL	M14X100	17,5	12,5	14	100
DA-TE12LLC-ZN	12LL	M16X100	18,5	12,5	17	100

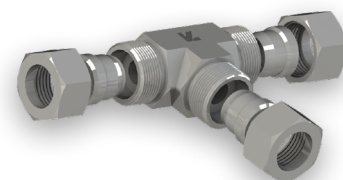

Gratissage

Coupleurs

Vannes Composants

Brides

Prises-Pression Manomètres

Colliers

Joints

Lavage

TE INEGAL



Référence	Ø Tube (mm)	F1	F2	F3	A	B	C	L1	L2	L3	H	PN (bar)
DA-TE081008L	08L - 10L - 08L	M14X150	M16X150	M14X150	22,0	22,0	22,0	15,0	15,0	15,0	17	500
DA-TE080810L	08L - 08L - 10L	M14X150	M14X150	M16X150	22,0	22,0	22,0	15,0	15,0	15,0	17	500
DA-TE081208L	08L - 12L - 08L	M14X150	M18X150	M14X150	24,0	24,0	24,0	17,0	17,0	17,0	19	400
DA-TE100810L	10L - 08L - 10L	M16X150	M14X150	M16X150	22,0	22,0	22,0	15,0	15,0	15,0	17	500
DA-TE101210L	10L - 12L - 10L	M16X150	M18X150	M16X150	24,0	24,0	24,0	17,0	17,0	17,0	19	400
DA-TE101012L	10L - 10L - 12L	M16X150	M16X150	M18X150	24,0	24,0	24,0	17,0	17,0	17,0	19	400
DA-TE121208L	12L - 12L - 08L	M18X150	M18X150	M14X150	24,0	24,0	23,0	17,0	17,0	16,0	19	400
DA-TE121210L	12L - 12L - 10L	M18X150	M18X150	M16X150	24,0	24,0	24,0	17,0	17,0	17,0	19	400
DA-TE121215L	12L - 12L - 15L	M18X150	M18X150	M22X150	28,0	28,0	28,0	21,0	21,0	21,0	19	400
DA-TE121512L	12L - 15L - 12L	M18X150	M22X150	M18X150	28,0	28,0	28,0	21,0	21,0	21,0	19	400
DA-TE151015L	15L - 10L - 15L	M22X150	M16X150	M22X150	28,0	28,0	28,0	21,0	21,0	21,0	19	400
DA-TE151215L	15L - 12L - 15L	M22X150	M18X150	M22X150	28,0	28,0	28,0	21,0	21,0	21,0	19	400
DA-TE151508L	15L - 15L - 08L	M22X150	M22X150	M14X150	28,0	28,0	26,0	21,0	21,0	19,0	19	400
DA-TE151510L	15L - 15L - 10L	M22X150	M22X150	M16X150	28,0	28,0	28,0	21,0	21,0	21,0	19	400
DA-TE151512L	15L - 15L - 12L	M22X150	M22X150	M18X150	28,0	28,0	28,0	21,0	21,0	21,0	19	400
DA-TE151518L	15L - 15L - 18L	M22X150	M22X150	M26X150	31,0	31,0	31,0	24,0	24,0	23,5	24	250
DA-TE151815L	15L - 18L - 18L	M22X150	M26X150	M22X150	31,0	31,0	31,0	24,0	23,5	24,0	24	250
DA-TE221022L	22L - 10L - 22L	M30X200	M16X150	M30X200	35,0	35,0	35,0	27,5	28,0	27,5	27	250
DA-TE221222L	22L - 12L - 22L	M30X200	M18X150	M30X200	35,0	35,0	35,0	27,5	28,0	27,5	27	250
DA-TE181822L	18L - 18L - 22L	M26X200	M26X150	M30X200	35,0	35,0	35,0	27,5	27,5	27,5	27	250
DA-TE221822L	22L - 18L - 22L	M30X200	M26X150	M30X200	35,0	35,0	35,0	27,5	27,5	27,5	27	250
DA-TE222215L	22L - 22L - 15L	M30X200	M30X200	M22X150	35,0	35,0	35,0	27,5	27,5	28,0	27	250
DA-TE222218L	22L - 22L - 18L	M30X200	M30X200	M26X150	35,0	35,0	35,0	27,5	27,5	27,5	27	250
DA-TE281528L	28L - 15L - 28L	M36X200	M22X150	M36X200	38,0	38,0	38,0	30,5	31,0	30,5	36	250

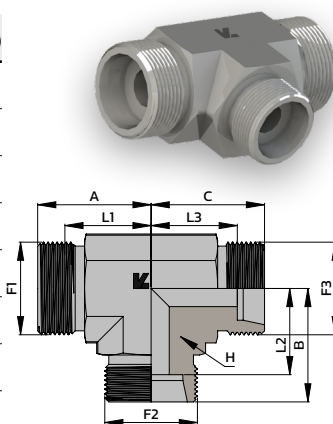

CROIX EGALE

Référence	Ø Tube (mm)	F	A	B	H	PN (bar)
DA-CRE06L	6L	M12X1,50	12,0	19,0	12	500
DA-CRE08L	8L	M14X150	10,5	21,0	14	500
DA-CRE10L	10L	M16X150	15,0	22,0	17	500
DA-CRE12L	12L	M18X150	17,0	24,0	19	400
DA-CRE15L	15L	M22X150	21,0	28,0	22	400
DA-CRE18L	18L	M26X150	23,5	31,0	24	400
DA-CRE22L	22L	M30X200	27,5	35,0	27	250
DA-CRE28L	28L	M36X200	30,5	38,0	36	250
DA-CRE35L	35L	M45X200	34,5	45,0	41	250
DA-CRE42L	42L	M52X200	40,0	51,0	50	250
DA-CRE06S	6S	M14X150	16,0	23,0	14	800
DA-CRE08S	8S	M16X150	17,0	24,0	17	800
DA-CRE10S	10S	M18X150	17,5	25,0	19	800
DA-CRE12S	12S	M20X150	21,5	29,0	22	630
DA-CRE14S	14S	M22X150	19,0	22,0	30	630
DA-CRE16S	16S	M24X150	24,5	33,0	24	630
DA-CRE20S	20S	M30X200	26,5	37,0	27	420
DA-CRE25S	25S	M36X200	30,0	42,0	36	420
DA-CRE30S	30S	M42X200	35,5	49,0	41	420
DA-CRE38S	38S	M52X200	41,0	57,0	50	420

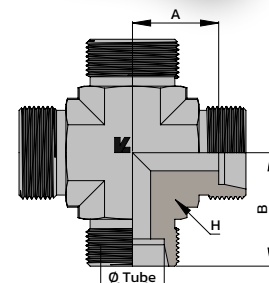
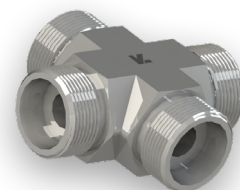

CROIX EGALE COMPLETE / SERIE LL



Référence	Ø Tube (mm)	F	A	B	H	PN (bar)
DA-CRE06LLC-ZN	6LL	M10X100	9,5	15,0	9	100

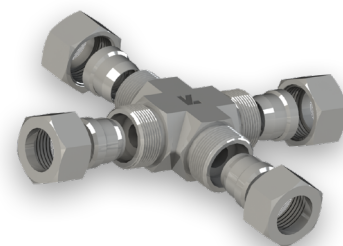

UNION DOUBLE PASSE-CLOISON

Référence	Ø Tube (mm)	F	A	L	L1	H	H1	PN (bar)
DA-UDPCL06L	6L	M12X150	48,0	7,0	27,0	17	17	500
DA-UDPCL08L	8L	M14X150	49,0	8,0	27,0	19	19	500
DA-UDPCL10L	10L	M16X150	52,0	10,0	28,0	22	22	500
DA-UDPCL12L	12L	M18X150	53,0	10,0	29,0	24	24	400
DA-UDPCL15L	15L	M22X150	57,0	12,0	31,0	27	30	400
DA-UDPCL18L	18L	M26X150	61,0	13,5	32,5	32	36	400
DA-UDPCL22L	22L	M30X200	66,0	16,5	34,5	36	41	250
DA-UDPCL28L	28L	M36X200	69,0	18,5	35,5	41	46	250
DA-UDPCL35L	35L	M45X200	76,0	18,5	36,5	50	55	250
DA-UDPCL42L	42L	M52X200	77,0	19,0	36,0	60	65	250

DA-UDPCL06S	6S	M14X150	55,0	12,0	29,0	19	19	800
DA-UDPCL08S	8S	M16X150	56,0	13,0	29,0	22	22	800
DA-UDPCL10S	10S	M18X150	59,0	14,5	29,5	24	24	800
DA-UDPCL12S	12S	M20X150	60,0	14,5	30,5	27	27	630
DA-UDPCL14S	14S	M22X150	65,0	17,0	32,0	30	30	630
DA-UDPCL16S	16S	M24X150	65,0	16,5	31,5	32	32	630
DA-UDPCL20S	20S	M30X200	72,0	17,5	33,5	41	41	420
DA-UDPCL25S	25S	M36X200	79,0	20,0	35,0	46	46	420
DA-UDPCL30S	30S	M42X200	86,0	21,5	37,5	50	50	420
DA-UDPCL38S	38S	M52X200	91,0	22,0	37,0	65	65	420

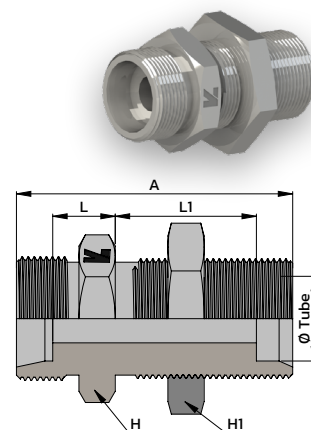
COUDE EGAL PASSE-CLOISON

Référence	Ø Tube (mm)	F	A	B	C	L	H	H1	PN (bar)
DA-CEPCL06L	6L	M12X150	48,0	19,0	41,0	27,0	12	17	500
DA-CEPCL08L	8L	M14X150	51,0	21,0	44,0	27,0	12	19	500
DA-CEPCL10L	10L	M16X150	53,0	22,0	46,0	28,0	14	22	500
DA-CEPCL12L	12L	M18X150	56,0	24,0	49,0	29,0	17	24	400
DA-CEPCL15L	15L	M22X150	61,0	28,0	54,0	31,0	22	30	400
DA-CEPCL18L	18L	M26X150	64,0	31,0	56,5	32,5	24	36	400
DA-CEPCL22L	22L	M30X200	72,0	35,0	64,5	34,5	27	41	250
DA-CEPCL28L	28L	M36X200	77,0	38,0	69,5	35,5	36	46	250
DA-CEPCL35L	35L	M45X200	86,0	45,0	75,5	36,5	41	55	250
DA-CEPCL42L	42L	M52X200	90,0	51,0	79,0	36,0	50	65	250

DA-CEPCL06S	6S	M14X150	53,0	23,0	46,0	29,0	12	19	800
DA-CEPCL08S	8S	M16X150	54,0	24,0	47,0	29,0	14	22	800
DA-CEPCL10S	10S	M18X150	57,0	25,0	49,5	29,5	17	24	800
DA-CEPCL12S	12S	M20X150	59,0	29,0	51,5	30,5	22	27	630
DA-CEPCL14S	14S	M22X150	63,0	30,0	55,0	32,0	19	30	630
DA-CEPCL16S	16S	M24X150	64,0	33,0	55,5	31,5	24	32	630
DA-CEPCL20S	20S	M30X200	74,0	37,0	63,5	33,5	27	41	420
DA-CEPCL25S	25S	M36X200	81,0	42,0	69,0	35,0	36	46	420
DA-CEPCL30S	30S	M42X200	90,0	49,0	76,5	37,5	41	50	420
DA-CEPCL38S	38S	M52X200	96,0	57,0	80,0	37,0	50	65	420

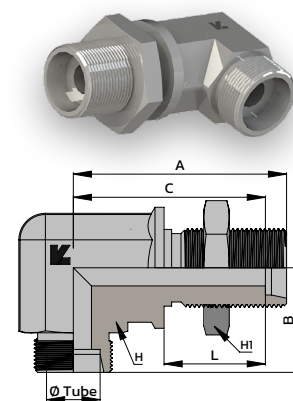

CONTRE-ECROU



Référence	Ø Tube (mm)	F	A	H
DA-CEC06L	6L	M12X150	6,0	17
DA-CEC08L	8L	M14X150	6,0	19
DA-CEC10L	10L	M16X150	6,0	22
DA-CEC12L	12L	M18X150	6,0	24
DA-CEC15L	15L	M22X150	7,0	30
DA-CEC18L	18L	M26X150	8,0	36
DA-CEC22L	22L	M30X200	8,0	41
DA-CEC28L	28L	M36X200	9,0	46
DA-CEC35L	35L	M45X200	9,0	55
DA-CEC42L	42L	M52X200	10,0	65
DA-CEC12S	12S	M20X150	6,0	27
DA-CEC16S	16S	M24X150	7,0	32
DA-CEC30S	30S	M42X200	9,0	50

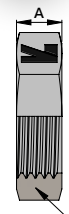
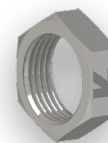

COUDE ORIENTABLE DKO

Référence	Ø Tube (mm)	F	A	B	L	H	H1	PN (bar)
DA-COR06LDKO	6L	M12X150	19,0	26,0	12,0	12	14	500
DA-COR08LDKO	8L	M14X150	21,0	27,5	14,0	14	17	500
DA-COR10LDKO	10L	M16X150	22,0	29,0	15,0	14	19	500
DA-COR12LDKO	12L	M18X150	24,0	29,5	17,0	17	22	400
DA-COR15LDKO	15L	M22X150	28,0	32,5	21,0	19	27	400
DA-COR18LDKO	18L	M26X150	31,0	35,5	23,5	24	32	400
DA-COR22LDKO	22L	M30X200	35,0	38,5	27,5	27	36	250
DA-COR28LDKO	28L	M36X200	38,0	41,5	30,5	36	41	250
DA-COR35LDKO	35L	M45X200	45,0	51,0	34,5	41	50	250
DA-COR42LDKO	42L	M52X200	51,0	56,0	40,0	50	60	250
DA-COR06SDKO	6S	M14X150	23,0	25,5	16,0	14	17	800
DA-COR08SDKO	8S	M16X150	24,0	27,0	17,0	17	19	800
DA-COR10SDKO	10S	M18X150	25,0	30,0	17,5	19	22	800
DA-COR12SDKO	12S	M20X150	29,0	31,0	21,5	17	24	630
DA-COR14SDKO	14S	M22X150	30,0	33,0	22,0	22	27	630
DA-COR16SDKO	16S	M24X150	33,0	36,0	24,5	24	30	630
DA-COR20SDKO	20S	M30X200	37,0	44,5	26,5	27	36	420
DA-COR25SDKO	25S	M36X200	42,0	50,0	30,0	36	46	420
DA-COR30SDKO	30S	M42X200	49,0	55,0	35,5	41	50	420
DA-COR38SDKO	38S	M52X200	57,0	63,0	41,0	50	60	420

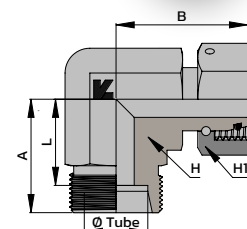
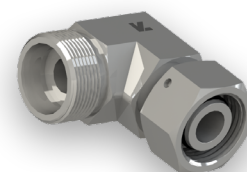

COUDE 45° ORIENTABLE DKO

Référence	Ø Tube (mm)	F	A	B	L	H	H1	PN (bar)
DA-COR4506LDKO	6L	M12X150	16,0	26,0	9,0	14	14	500
DA-COR4508LDKO	8L	M14X150	19,0	27,0	12,0	14	17	500
DA-COR4510LDKO	10L	M16X150	19,0	29,0	12,0	19	19	500
DA-COR4512LDKO	12L	M18X150	21,0	29,5	14,0	19	22	400
DA-COR4515LDKO	15L	M22X150	24,0	28,5	18,0	19	27	400
DA-COR4518LDKO	18L	M26X150	24,0	35,5	16,5	27	32	400
DA-COR4522LDKO	22L	M30X200	26,0	38,5	18,5	30	36	250
DA-COR4528LDKO	28L	M36X200	31,0	41,5	23,5	36	41	250
DA-COR4535LDKO	35L	M45X200	37,0	51,0	26,5	41	50	250
DA-COR4542LDKO	42L	M52X200	37,0	56,0	26,0	50	60	250
DA-COR4506SDKO	6S	M14X150	16,0	27,0	9,0	14	17	800
DA-COR4508SDKO	8S	M16X150	19,0	27,5	12,0	17	19	800
DA-COR4510SDKO	10S	M18X150	21,0	30,0	13,5	19	22	800
DA-COR4512SDKO	12S	M20X150	24,0	31,0	16,5	22	24	630
DA-COR4514SDKO	14S	M22X150	-	35,0	-	22	27	630
DA-COR4516SDKO	16S	M24X150	24,0	36,5	15,5	27	30	630
DA-COR4520SDKO	20S	M30X200	26,5	44,5	16,0	27	36	420
DA-COR4525SDKOV*	25S	M36X200	30,5	50,0	18,5	36	46	420
DA-COR4530SDKO	30S	M42X200	37,0	55,0	23,5	41	50	420
DA-COR4538SDKO	38S	M52X200	37,0	63,0	21,0	50	60	420

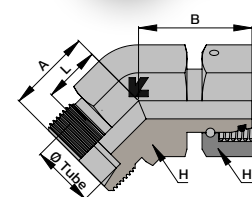
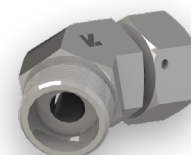

* Joint Viton

TE ORIENTABLE DKO

Référence	Ø Tube (mm)	F	A	B	L	H	H1	PN (bar)
DA-TOR06LDKO	6L	M12X150	19,0	26,0	12,0	14	17	500
DA-TOR08LDKO	8L	M14X150	21,0	27,5	14,0	14	17	500
DA-TOR10LDKO	10L	M16X150	22,0	29,0	15,0	14	19	500
DA-TOR12LDKO	12L	M18X150	24,0	29,5	17,0	17	22	400
DA-TOR15LDKO	15L	M22X150	28,0	32,5	21,0	19	27	400
DA-TOR18LDKO	18L	M26X150	31,0	34,5	23,5	24	32	400
DA-TOR22LDKO	22L	M30X200	35,0	38,5	27,5	27	36	250
DA-TOR28LDKO	28L	M36X200	38,0	41,5	30,5	36	41	250
DA-TOR35LDKO	35L	M45X200	45,0	51,0	34,5	41	50	250
DA-TOR42LDKO	42L	M52X200	51,0	53,5	40,0	50	60	250
DA-TOR06SDKO	6S	M14X150	23,0	27,0	16,0	14	17	800
DA-TOR08SDKO	8S	M16X150	24,0	27,5	17,0	17	19	800
DA-TOR10SDKO	10S	M18X150	25,0	30,0	17,5	19	22	800
DA-TOR12SDKO	12S	M20X150	29,0	31,0	21,5	17	24	630
DA-TOR14SDKO	14S	M22X150	30,0	35,0	22,0	22	27	630
DA-TOR16SDKO	16S	M24X150	33,0	35,0	24,5	24	30	630
DA-TOR20SDKO	20S	M30X200	37,0	44,5	26,5	27	36	420
DA-TOR25SDKO	25S	M36X200	42,0	50,0	30,0	36	46	420
DA-TOR30SDKO	30S	M42X200	49,0	55,0	35,5	41	50	420
DA-TOR38SDKO	38S	M52X200	57,0	63,0	41,0	50	60	420

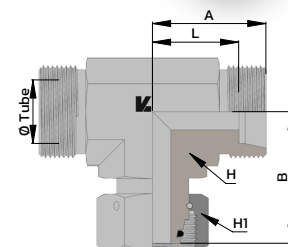
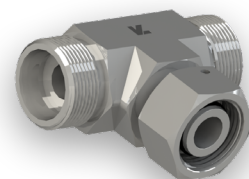

Embout

Protections

DIN

JIC

ORFS

BSP

GAZ

TE ORIENTABLE RENVERSE DKO

Référence	Ø Tube (mm)	F	A	B	L	L1	H	H1	PN (bar)
DA-TORRO6LDKO	6L	M12X150	45,0	19,0	12,0	26,0	12	14	500
DA-TORRO8LDKO	8L	M14X150	45,0	21,0	14,0	26,0	14	17	500
DA-TORR10LDKO	10L	M16X150	49,0	22,0	22,0	27,0	14	19	500
DA-TORR12LDKO	12L	M18X150	53,5	24,0	17,0	29,5	17	22	400
DA-TORR15LDKO	15L	M22X150	60,5	28,0	21,0	32,5	19	27	400
DA-TORR18LDKO	18L	M26X150	66,5	31,0	23,5	35,5	24	32	400
DA-TORR22LDKO	22L	M30X200	73,5	35,0	24,5	38,5	27	36	250
DA-TORR28LDKO	28L	M36X200	79,5	38,0	30,5	41,5	36	41	250
DA-TORR35LDKO	35L	M45X200	96,0	45,0	34,5	51,0	41	50	250
DA-TORR42LDKO	42L	M52X200	104,5	51,0	40,0	53,5	50	60	250
DA-TORRO6SDKO	6S	M14X150	50,0	23,0	16,0	27,0	14	17	800
DA-TORRO8SDKO	8S	M16X150	51,5	24,0	17,0	27,5	17	19	800
DA-TORR10SDKO	10S	M18X150	55,0	25,0	17,5	30,0	19	22	800
DA-TORR12SDKO	12S	M20X150	60,0	29,0	21,5	31,0	17	24	630
DA-TORR14SDKO	14S	M22X150	65,0	30,0	22,0	35,0	22	27	630
DA-TORR16SDKO	16S	M24X150	68,0	33,0	24,5	35,0	24	30	630
DA-TORR20SDKO	20S	M30X200	81,5	37,0	26,5	44,5	27	36	420
DA-TORR25SDKO	25S	M36X200	88,5	42,0	30,0	46,5	36	46	420
DA-TORR30SDKO	30S	M42X200	104,0	49,0	35,5	55,0	41	50	420
DA-TORR38SDKO	38S	M52X200	120,0	57,0	41,0	63,0	50	60	420

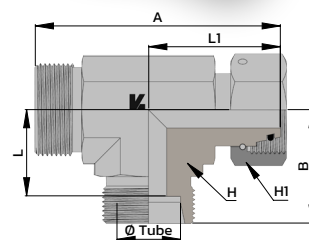
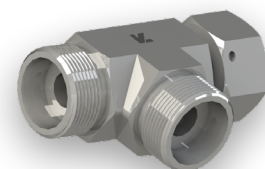

Gratissage

Coupleurs

Vannes
Composants

Brides

Prises-Pression
Manomètres

Colliers

Joint

Lavage

UNION FEMELLE / FEMELLE DKO



Référence	Ø Tube (mm)	F1	F2	A	H	H1	PN (bar)
DA-UFF06LDKO	6L	M12X150	M12X150	33,0	14	14	500
DA-UFF08LDKO	8L	M14X150	M14X150	33,0	17	17	500
DA-UFF10LDKO	10L	M16X150	M16X150	37,0	19	19	500
DA-UFF12LDKO	12L	M18X150	M18X150	37,0	22	22	400
DA-UFF12/10LDKO	12L / 10L	M18X150	M16X150	33,0	22	19	400
DA-UFF15LDKO	15L	M22X150	M22X150	38,0	27	27	400
DA-UFF15/10LDKO	15L / 10L	M22X150	M16X150	38,0	27	19	400
DA-UFF15/12LDKO	15L / 12L	M22X150	M18X150	38,0	27	22	400
DA-UFF18LDKO	18L	M26X150	M26X150	40,0	32	32	400
DA-UFF18/15LDKO	18L / 15L	M26X150	M22X150	38,0	32	27	400
DA-UFF22LDKO	22L	M30X200	M30X200	44,0	36	36	250
DA-UFF28LDKO	28L	M36X200	M36X200	48,0	41	41	250
DA-UFF35LDKO	35L	M45X200	M45X200	52,0	50	50	250
DA-UFF42LDKO	42L	M52X200	M52X200	57,0	60	60	250
DA-UFF06SDKO	6S	M14X150	M14X150	33,0	17	17	800
DA-UFF08SDKO	8S	M16X150	M16X150	38,0	19	19	800
DA-UFF10SDKO	10S	M18X150	M18X150	35,0	22	22	800
DA-UFF12SDKO	12S	M20X150	M20X150	40,0	24	24	630
DA-UFF14SDKO	14S	M22X150	M22X150	41,0	27	27	630
DA-UFF16SDKO	16S	M24X150	M24X150	43,0	30	30	630
DA-UFF20SDKO	20S	M30X200	M30X200	48,0	36	36	420
DA-UFF25SDKO	25S	M36X200	M36X200	53,0	46	46	420
DA-UFF30SDKO	30S	M42X200	M42X200	62,0	50	50	420
DA-UFF38SDKO	38S	M52X200	M52X200	67,0	60	60	420

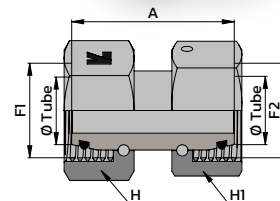
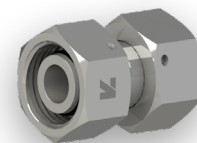

UNION FEMELLE SERIE L / FEMELLE BSPP FIXE



Référence	Ø Tube (mm)	F1	F2	A	H	H1	PN (bar)
DA-UFF15L1/2DKO	15L	M22X150	1/2"	46,0	27	27	200

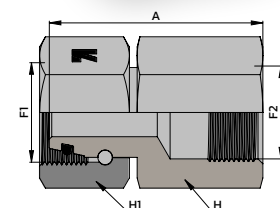
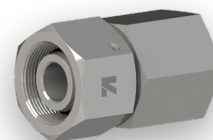



ADAPTATEUR DE REDUCTION DKO / SERIE L

Référence	Ø Tube (mm)	F1	F2	A	L	H	H1	PN (bar)
DA-ADRO6/08LDKO	06L / 08L	M12X150	M14X150	32,0	25,0	14	14	500
DA-ADRO8/06LDKO	08L / 06L	M14X150	M12X150	30,0	23,5	12	17	500
DA-ADRO8/10LDKO	08L / 10L	M14X150	M16X150	17,0	17,0	42	35	500
DA-ADR10/06LDKO	10L / 06L	M16X150	M12X150	31,5	25,0	14	19	500
DA-ADR10/08LDKO	10L / 08L	M16X150	M14X150	31,5	25,0	14	19	500
DA-ADR10/12LDKO	10L / 12L	M16X150	M18X150	19,0	19,0	19	19	400
DA-ADR10/15LDKO	10L / 15L	M16X150	M22X150	37,0	30,0	24	19	400
DA-ADR12/06LDKO	12L / 06L	M18X150	M12X150	32,0	25,0	17	22	400
DA-ADR12/08LDKO	12L / 08L	M18X150	M14X150	31,5	25,0	17	22	400
DA-ADR12/10LDKO	12L / 10L	M18X150	M16X150	33,5	26,0	17	22	400
DA-ADR12/15LDKO	12L / 15L	M18X150	M22X150	24,0	22,0	35	28	400
DA-ADR15/06LDKO	15L / 06L	M22X150	M12X150	35,0	28,0	19	27	400
DA-ADR15/08LDKO	15L / 08L	M22X150	M14X150	35,0	28,0	24	27	400
DA-ADR15/10LDKO	15L / 10L	M22X150	M16X150	36,0	29,0	22	27	400
DA-ADR15/12LDKO	15L / 12L	M22X150	M18X150	36,0	29,0	22	27	400
DA-ADR15/18LDKO	15L / 18L	M22X150	M26X150	39,0	31,0	27	27	400
DA-ADR15/22LDKO	15L / 22L	M22X150	M30X200	40,0	32,5	32	27	250
DA-ADR18/08LDKO	18L / 08L	M26X150	M14X150	35,0	28,0	24	32	400
DA-ADR18/10LDKO	18L / 10L	M26X150	M16X150	36,5	29,0	24	32	400
DA-ADR18/12LDKO	18L / 12L	M26X150	M18X150	36,0	29,0	27	32	400
DA-ADR18/15LDKO	18L / 15L	M26X150	M22X150	37,5	30,0	27	32	400
DA-ADR22/10LDKO	22L / 10L	M30X200	M16X150	39,0	33,0	27	36	250
DA-ADR22/12LDKO	22L / 12L	M30X200	M18X150	39,0	33,0	27	36	250
DA-ADR22/15LDKO	22L / 15L	M30X200	M22X150	40,0	34,0	27	36	250
DA-ADR22/18LDKO	22L / 18L	M30X200	M26X150	40,0	34,0	27	36	250
DA-ADR28/10LDKO	28L / 10L	M36X200	M16X150	40,0	35,0	32	41	250
DA-ADR28/12LDKO	28L / 12L	M36X200	M18X150	41,0	35,0	32	41	250
DA-ADR28/15LDKO	28L / 15L	M36X200	M22X150	41,0	36,0	35	41	250
DA-ADR28/18LDKO	28L / 18L	M36X200	M26X150	41,0	36,5	36	41	250
DA-ADR28/22LDKO	28L / 22L	M36X200	M30X200	44,0	36,5	32	41	250
DA-ADR35/12LDKO	35L / 12L	M45X200	M18X150	-	-	-	-	250
DA-ADR35/15LDKO	35L / 15L	M45X200	M22X150	44,0	33,5	41	50	250
DA-ADR35/18LDKO	35L / 18L	M45X200	M26X150	44,0	39,0	41	50	250
DA-ADR35/22LDKO	35L / 22L	M45X200	M30X200	46,0	39,5	41	50	250
DA-ADR35/28LDKO	35L / 28L	M45X200	M36X200	48,0	40,5	41	50	250
DA-ADR42/18LDKO	42L / 18L	M52X200	M26X150	47,0	42,0	50	60	250
DA-ADR42/22LDKO	42L / 22L	M52X200	M30X200	49,0	44,0	50	60	250
DA-ADR42/28LDKO	42L / 28L	M52X200	M36X200	49,0	44,0	50	60	250
DA-ADR42/35LDKO	42L / 35L	M52X200	M36X200	51,0	44,0	50	60	250

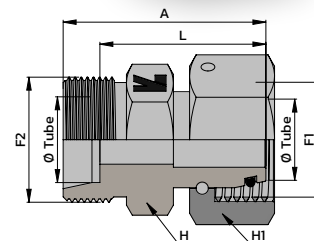
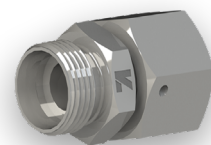

ADAPTATEUR EGAL DKO / SERIE L



Référence	Ø Tube (mm)	F	A	L	H	H1	PN (bar)
DA-ADO8LDKO	08L	M14X150	43,0	36,0	14	17	500
DA-AD10LDKO	10L	M16X150	43,0	36,0	17	19	500
DA-AD12LDKO	12L	M18X150	43,0	36,0	19	22	400
DA-AD15LDKO	15L	M22X150	43,0	36,0	24	27	400
DA-AD22LDKO	22L	M30X200	47,5	40,0	32	36	250

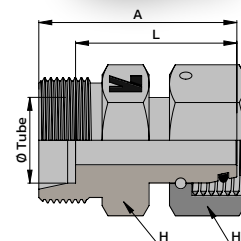
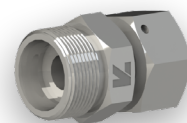



ADAPTATEUR DE REDUCTION DKO / SERIE S

Référence	Ø Tube (mm)	F1	F2	A	L	H	H1	PN (bar)
DA-ADR08/06SDKO	08S / 06S	M16X150	M14X150	35,0	27,0	14	19	800
DA-ADR10/06SDKO	10S / 06S	M18X150	M14X150	37,5	27,5	17	22	800
DA-ADR10/08SDKO	10S / 08S	M18X150	M16X150	34,5	27,5	17	22	800
DA-ADR12/06SDKO	12S / 06S	M20X150	M14X150	38,0	29,0	17	24	630
DA-ADR12/08SDKO	12S / 08S	M20X150	M16X150	36,0	29,0	19	24	630
DA-ADR12/10SDKO	12S / 10S	M20X150	M18X150	35,0	29,0	19	24	630
DA-ADR14/10SDKO	14S / 10S	M22X150	M18X150	40,5	31,0	19	27	630
DA-ADR14/12SDKO	14S / 12S	M22X150	M20X150	38,5	31,0	22	27	630
DA-ADR16/06SDKO	16S / 06S	M24X150	M14X150	41,0	32,0	22	30	630
DA-ADR16/08SDKO	16S / 08S	M24X150	M16X150	37,5	32,0	22	30	630
DA-ADR16/10SDKO	16S / 10S	M24X150	M18X150	38,0	31,5	22	30	630
DA-ADR16/12SDKO	16S / 12S	M24X150	M20X150	37,5	30,0	22	30	630
DA-ADR16/14SDKO	16S / 14S	M24X150	M22X150	43,0	33,0	24	30	630
DA-ADR20/06SDKO	20S / 06S	M30X200	M14X150	45,5	36,0	27	36	420
DA-ADR20/08SDKO	20S / 08S	M30X200	M16X150	41,0	36,0	27	36	420
DA-ADR20/10SDKO	20S / 10S	M30X200	M18X150	45,5	35,5	27	36	420
DA-ADR20/12SDKO	20S / 12S	M30X200	M20X150	40,5	33,0	27	36	420
DA-ADR20/14SDKO	20S / 14S	M30X200	M22X150	47,5	37,0	27	36	420
DA-ADR20/16SDKO	20S / 16S	M30X200	M24X150	43,0	34,5	30	36	420
DA-ADR25/10SDKO	25S / 10S	M36X200	M18X150	49,0	38,0	32	46	420
DA-ADR25/12SDKO	25S / 12S	M36X200	M20X150	49,0	38,0	32	46	420
DA-ADR25/14SDKO	25S / 14S	M36X200	M22X150	51,0	39,5	32	46	420
DA-ADR25/16SDKO	25S / 16S	M36X200	M24X150	47,5	39,0	32	46	420
DA-ADR25/20SDKO	25S / 20S	M36X200	M30X200	45,5	35,0	36	46	420
DA-ADR30/10SDKO	30S / 10S	M42X200	M18X150	53,0	43,5	41	50	420
DA-ADR30/12SDKO	30S / 12S	M42X200	M20X150	53,0	43,5	41	50	420
DA-ADR30/16SDKO	30S / 16S	M42X200	M24X150	48,0	44,5	41	50	420
DA-ADR30/20SDKO	30S / 20S	M42X200	M30X200	51,5	44,5	41	50	420
DA-ADR30/25SDKO	30S / 25S	M42X200	M36X200	52,0	45,0	41	50	420
DA-ADR38/16SDKO	38S / 16S	M52X200	M24X150	59,0	48,0	50	60	420
DA-ADR38/20SDKO	38S / 20S	M52X200	M30X200	51,0	48,0	50	60	420
DA-ADR38/25SDKO	38S / 25S	M52X200	M36X200	62,5	48,5	50	60	420
DA-ADR38/30SDKO	38S / 30S	M52X200	M42X200	64,5	49,0	50	60	420

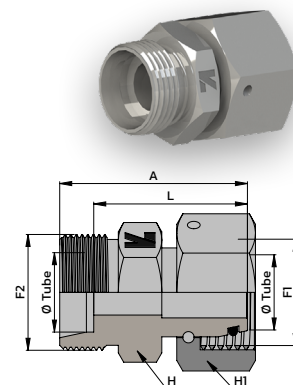

ADAPTATEUR EGAL DKO / SERIE S

Référence	Ø Tube (mm)	F	A	L	H	H1	PN (bar)
DA-AD12SDKO	12S	M20X150	43,5	36,0	22	24	630
DA-AD20SDKO	20S	M30X200	56,5	46,0	32	36	420
DA-AD30SDKO	30S	M42X200	69,5	56,0	46	50	420

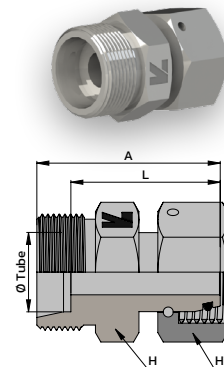

UNION MALE BSPP JE / SERIE L



Référence	Ø Tube (mm)	F1	F2	A	B	L	H	PN (bar)
DA-UM06LR1/8JE	6L	M12X150	1/8"	23,5	8,0	8,5	14	500
DA-UM06LR1/4JE	6L	M12X150	1/4"	29,0	12,0	10,0	19	500
DA-UM06LR3/8JE	6L	M12X150	3/8"	30,5	12,0	11,5	22	420
DA-UM06LR1/2JE	6L	M12X150	1/2"	33,0	14,0	12,0	27	400
DA-UM08LR1/8JE	8L	M14X150	1/8"	24,5	8,0	9,5	14	500
DA-UM08LR1/4JE	8L	M14X150	1/4"	29,0	12,0	10,0	19	500
DA-UM08LR3/8JE	8L	M14X150	3/8"	30,5	12,0	11,5	22	420
DA-UM08LR1/2JE	8L	M14X150	1/2"	35,0	14,0	13,0	27	400
DA-UM10LR1/8JE	10L	M16X150	1/8"	25,5	8,0	10,5	17	500
DA-UM10LR1/4JE	10L	M16X150	1/4"	30,0	12,0	11,0	19	500
DA-UM10LR3/8JE	10L	M16X150	3/8"	31,5	12,0	12,5	22	420
DA-UM10LR1/2JE	10L	M16X150	1/2"	35,0	14,0	13,0	27	400
DA-UM10LR3/4JE	10L	M16X150	3/4"	37,0	16,0	14,5	32	250
DA-UM12LR1/4JE	12L	M18X150	1/4"	31,0	12,0	12,0	19	400
DA-UM12LR3/8JE	12L	M18X150	3/8"	31,5	12,0	12,5	22	420
DA-UM12LR1/2JE	12L	M18X150	1/2"	34,0	14,0	13,0	27	400
DA-UM12LR3/4JE	12L	M18X150	3/4"	39,5	16,0	14,0	32	250
DA-UM15LR1/4JE	15L	M22X150	1/4"	32,5	12,0	13,5	24	400
DA-UM15LR3/8JE	15L	M22X150	3/8"	32,5	12,0	14,0	24	400
DA-UM15LR1/2JE	15L	M22X150	1/2"	35,0	14,0	14,0	27	400
DA-UM15LR3/4JE	15L	M22X150	3/4"	38,0	16,0	15,0	32	250
DA-UM15LR1JE	15L	M22X150	1"	41,0	18,0	16,0	41	250
DA-UM18LR3/8JE	18L	M26X150	3/8"	34,0	12,0	14,5	27	400
DA-UM18LR1/2JE	18L	M26X150	1/2"	36,0	14,0	14,5	27	400
DA-UM18LR3/4JE	18L	M26X150	3/4"	38,0	16,0	14,5	32	250
DA-UM18LR1JE	18L	M26X150	1"	43,0	18,0	17,5	41	250
DA-UM22LR1/2JE	22L	M30X200	1/2"	38,0	14,0	16,5	32	250
DA-UM22LR3/4JE	22L	M30X200	3/4"	40,0	16,0	16,5	32	250
DA-UM22LR1JE	22L	M30X200	1"	43,0	18,0	17,5	41	250
DA-UM22LR1.1/4JE	22L	M30X200	1"1/4	46,0	20,0	18,5	50	250
DA-UM28LR3/4JE	28L	M36X200	3/4"	41,0	16,0	17,5	41	250
DA-UM28LR1JE	28L	M36X200	1"	43,0	18,0	17,5	41	250
DA-UM28LR1.1/4JE	28L	M36X200	1"1/4	46,0	20,0	18,5	50	250
DA-UM28LR1.1/2JE	28L	M36X200	1"1/2	-	-	-	-	250
DA-UM35LR1JE	35L	M45X200	1"	46,0	18,0	17,5	46	250
DA-UM35LR1.1/4JE	35L	M45X200	1"1/4	48,0	20,0	17,5	50	250
DA-UM35LR1.1/2JE	35L	M45X200	1"1/2	52,0	22,0	19,5	55	250
DA-UM42LR1.1/4JE	42L	M52X200	1"1/4	50,0	20,0	19,0	55	250
DA-UM42LR1.1/2JE	42L	M52X200	1"1/2	52,0	22,0	19,0	55	250

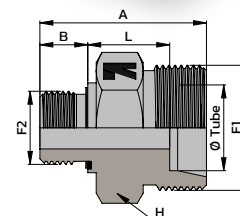
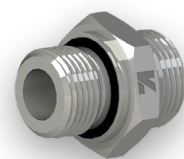

UNION MALE BSPP JE COMPLETE / SERIE LL

Référence	Ø Tube (mm)	F1	F2	A	B	L	H	PN (bar)
DA-UM04LLR1/8JEC-Z	4LL	M8X100	1/8"	21,5	8,0	9,5	14	100
DA-UM06LLR1/8JEC-Z	6LL	M10X100	1/8"	21,5	8,0	8,0	14	100
DA-UM08LLR1/8JEC-Z	8LL	M12X100	1/8"	22,5	9,0	8,0	14	100

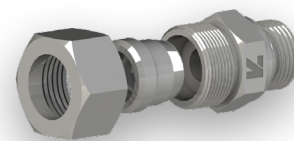

UNION MALE BSPP JE ROTATIVE / SERIE L



Référence	Ø Tube (mm)	F1	F2	A	B	L	H	H1	PN (bar)
DA-UM06LR1/4JE-RO	6L	M12X150	1/4"	61,0	49,0	12,0	22,0	17	250
DA-UM08LR1/4JE-RO	8L	M14X150	1/4"	61,0	49,0	12,0	22,0	17	250
DA-UM10LR1/4JE-RO	10L	M16X150	1/4"	63,0	51,0	12,0	22,0	17	250
DA-UM10LR3/8JE-RO	10L	M16X150	3/8"	72,5	60,5	12,0	30,0	24	250
DA-UM12LR3/8JE-RO	12L	M18X150	3/8"	72,5	60,5	12,0	30,0	24	250
DA-UM12LR1/2JE-RO	12L	M18X150	1/2"	74,0	60,0	14,0	30,0	24	250
DA-UM15LR1/2JE-RO	15L	M22X150	1/2"	74,0	60,0	14,0	30,0	24	250

Température d'utilisation : -25 °C à +80 °C

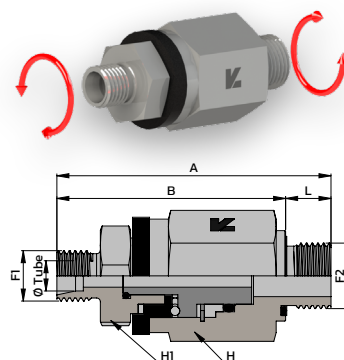

VITESSES DE ROTATION ET COUPLES

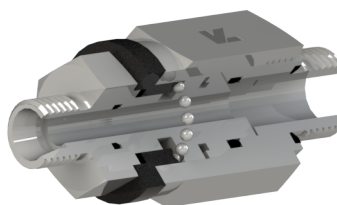

Ø Tube (mm)	Vitesse de rotation admissible (tr/min) suivant la pression de service					Couple de démarrage à 250 bar (N.m)
	25 bar	65 bar	100 bar	160 bar	250 bar	
6	1500	750	400	200	85	0,08
8	1500	750	400	200	85	0,08
10	800	400	200	100	45	0,24
12	800	400	200	100	45	0,24
15	800	400	200	100	45	0,24

UNION MALE BSPP JE / SERIE S

Référence	Ø Tube (mm)	F1	F2	A	B	L	H	PN (bar)
DA-UM06SR1/4JE	6S	M14X150	1/4"	32,0	12,0	13,0	19	800
DA-UM08SR1/4JE	8S	M16X150	1/4"	34,0	12,0	15,0	19	800
DA-UM08SR3/8JE	8S	M16X150	3/8"	34,5	12,0	15,5	22	800
DA-UM08SR1/2JE	8S	M16X150	1/2"	36,5	14,0	15,5	27	630
DA-UM10SR1/4JE	10S	M18X150	1/4"	34,0	12,0	14,5	19	800
DA-UM10SR3/8JE	10S	M18X150	3/8"	34,5	12,0	15,0	22	800
DA-UM10SR1/2JE	10S	M18X150	1/2"	39,0	14,0	17,5	27	630
DA-UM12SR1/4JE	12S	M20X150	1/4"	36,0	12,0	16,5	22	630
DA-UM12SR3/8JE	12S	M20X150	3/8"	36,5	12,0	17,0	22	630
DA-UM12SR1/2JE	12S	M20X150	1/2"	39,0	14,0	17,5	27	630
DA-UM14SR3/8JE	14S	M22X150	3/8"	35,0	12,0	15,0	27	630
DA-UM14SR1/2JE	14S	M22X150	1/2"	41,0	14,0	19,0	27	630
DA-UM16SR3/8JE	16S	M24X150	3/8"	38,5	12,0	18,0	27	630
DA-UM16SR1/2JE	16S	M24X150	1/2"	41,0	14,0	18,5	27	630
DA-UM16SR3/4JE	16S	M24X150	3/4"	45,0	16,0	20,5	32	420
DA-UM20SR1/2JE	20S	M30X200	1/2"	45,0	14,0	20,5	32	420
DA-UM20SR3/4JE	20S	M30X200	3/4"	47,0	16,0	20,5	32	420
DA-UM20SR1JE	20S	M30X200	1"	51,0	18,0	22,5	41	420
DA-UM25SR1/2JE	25S	M36X200	1/2"	49,2	14,0	23,0	41	420
DA-UM25SR3/4JE	25S	M36X200	3/4"	51,0	16,0	23,0	41	420
DA-UM25SR1JE	25S	M36X200	1"	53,0	18,0	23,0	41	420
DA-UM25SR1.1/4JE	25S	M36X200	1"1/4	55,0	20,0	23,0	50	420
DA-UM30SR3/4JE	30S	M42X200	3/4"	53,0	16,0	23,5	46	420
DA-UM30SR1JE	30S	M42X200	1"	55,0	18,0	23,5	46	420
DA-UM30SR1.1/4JE	30S	M42X200	1"1/4	57,0	20,0	23,5	50	420
DA-UM30SR1.1/2JE	30S	M42X200	1"1/2	62,0	22,0	26,5	55	420
DA-UM38SR1.1/4JE	38S	M52X200	1"1/4	62,0	20,0	26,0	55	420
DA-UM38SR1.1/2JE	38S	M52X200	1"1/2	64,0	22,0	26,0	55	420

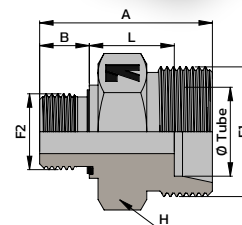
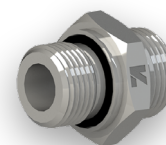

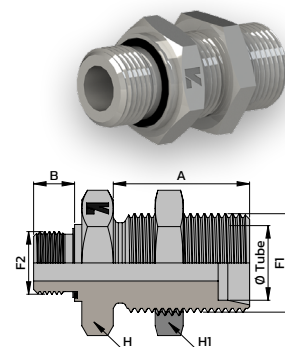

UNION MALE PASSE-CLOISON BSPP JE

Référence	Ø Tube (mm)	F1	F2	A	B	H	H1	PN (bar)
DA-UM06LR1/8JE-PCL	6L	M12X150	1/8"	34,0	8,0	17	17	500
DA-UM06LR1/4JE-PCL	6L	M12X150	1/4"	34,0	12,0	19	17	500
DA-UM08LR1/4JE-PCL	8L	M14X150	1/4"	34,0	12,0	19	19	500
DA-UM08LR3/8JE-PCL	8L	M14X150	3/8"	34,0	12,0	22	19	420
DA-UM08LR1/2JE-PCL	8L	M14X150	1/2"	34,0	14,0	27	19	400
DA-UM10LR1/4JE-PCL	10L	M16X150	1/4"	35,0	12,0	22	22	500
DA-UM10LR3/8JE-PCL	10L	M16X150	3/8"	35,0	12,0	22	22	420
DA-UM10LR1/2JE-PCL	10L	M16X150	1/2"	35,0	14,0	27	22	400
DA-UM12LR1/4JE-PCL	12L	M18X150	1/4"	36,0	12,0	24	24	400
DA-UM12LR3/8JE-PCL	12L	M18X150	3/8"	36,0	12,0	24	24	420
DA-UM12LR1/2JE-PCL	12L	M18X150	1/2"	36,0	14,0	27	24	400
DA-UM15LR3/8JE-PCL	15L	M22X150	3/8"	38,0	12,0	24	30	400
DA-UM15LR1/2JE-PCL	15L	M22X150	1/2"	38,0	14,0	27	30	400
DA-UM15LR3/4JE-PCL	15L	M22X150	3/4"	38,0	16,0	32	30	250
DA-UM18LR1/2JE-PCL	18L	M26X150	1/2"	40,0	14,0	32	36	400
DA-UM18LR3/4JE-PCL	18L	M16X150	3/4"	40,0	16,0	32	36	250
DA-UM18LR1JE-PCL	18L	M26X150	1"	40,0	18,0	41	36	250
DA-UM22LR1/2JE-PCL	22L	M30X200	1/2"	42,0	14,0	32	41	250
DA-UM22LR3/4JE-PCL	22L	M30X200	3/4"	42,0	16,0	36	41	250
DA-UM28LR3/4JE-PCL	28L	M36X200	3/4"	43,0	16,0	41	46	250
DA-UM28LR1JE-PCL	28L	M36X200	1"	43,0	18,0	41	46	250
DA-UM28LR1.1/4JE-P	28L	M36X200	1"1/4	43,0	20,0	50	46	250
DA-UM35LR1.1/4JE-P	35L	M45X200	1"1/4	47,0	20,0	50	55	250
DA-UM35LR1.1/2JE-P	35L	M45X200	1"1/2	47,0	22,0	55	55	250
DA-UM42LR1.1/2JE-P	42L	M52X200	1"1/2	47,0	22,0	55	65	250
DA-UM06SR1/4JE-PCL	6S	M14X150	1/4"	36,0	12,0	19	19	800
DA-UM08SR1/4JE-PCL	8S	M16X150	1/4"	36,0	12,0	19	22	800
DA-UM08SR3/8JE-PCL	8S	M16X150	3/8"	36,0	12,0	22	22	800
DA-UM10SR3/8JE-PCL	10S	M18X150	3/8"	37,0	12,0	24	24	800
DA-UM10SR1/2JE-PCL	10S	M18X150	1/2"	37,0	14,0	27	24	630
DA-UM12SR3/8JE-PCL	12S	M20X150	3/8"	38,0	12,0	27	27	630
DA-UM12SR1/2JE-PCL	12S	M20X150	1/2"	38,0	14,0	27	27	630
DA-UM14SR1/2JE-PCL	14S	M22X150	1/2"	40,0	14,0	27	30	630
DA-UM16SR1/2JE-PCL	16S	M24X150	1/2"	40,0	14,0	27	32	630
DA-UM16SR3/4JE-PCL	16S	M24X150	3/4"	40,0	16,0	32	32	420
DA-UM20SR1/2JE-PCL	20S	M30X200	1/2"	44,0	14,0	36	41	420
DA-UM20SR3/4JE-PCL	20S	M30X200	3/4"	44,0	16,0	36	41	420
DA-UM20SR1JE-PCL	20S	M30X200	1"	44,0	18,0	41	41	420
DA-UM25SR3/4JE-PCL	25S	M36X200	3/4"	47,0	16,0	41	46	420
DA-UM25SR1JE-PCL	25S	M36X200	1"	47,0	18,0	41	46	420
DA-UM30SR1JE-PCL	30S	M42X200	1"	51,0	18,0	50	50	420
DA-UM30SR1.1/4JE-P	30S	M42X200	1"1/4	51,0	20,0	50	50	420
DA-UM38SR1.1/4JE-P	38S	M52X200	1"1/4	53,0	20,0	60	65	420
DA-UM38SR1.1/2JE-P	38S	M52X200	1"1/2	53,0	22,0	60	65	420

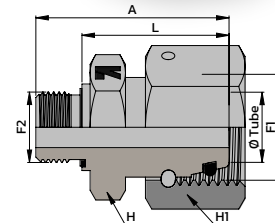
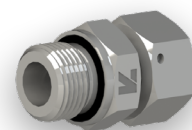

ADAPTATEUR TOURNANT DKO / BSPP JE

Référence	Ø Tube (mm)	F1	F2	A	L	H	H1	PN (bar)
DA-ADO6LDKOR1/8JE	6L	M12X150	1/8"	32,5	24,5	14	14	500
DA-ADO6LDKOR1/4JE	6L	M12X150	1/4"	38,5	26,5	19	14	500
DA-ADO8LDKOR1/4JE	8L	M14X150	1/4"	40,0	28,0	19	17	500
DA-ADO8LDKOR3/8JE	8L	M14X150	3/8"	40,0	28,0	22	17	420
DA-AD10LDKOR1/4JE	10L	M16X150	1/4"	39,0	27,0	19	19	500
DA-AD10LDKOR3/8JE	10L	M16X150	3/8"	40,0	28,0	22	19	420
DA-AD10LDKOR1/2JE	10L	M16X150	1/2"	41,5	27,5	27	19	420
DA-AD12LDKOR1/4JE	12L	M18X150	1/4"	39,0	27,0	19	22	400
DA-AD12LDKOR3/8JE	12L	M18X150	3/8"	45,0	33,0	22	22	400
DA-AD12LDKOR1/2JE	12L	M18X150	1/4"	43,0	29,0	27	22	400
DA-AD15LDKOR3/8JE	15L	M22X150	3/8"	44,0	32,0	22	27	400
DA-AD15LDKOR1/2JE	15L	M22X150	1/2"	45,5	31,5	27	27	400
DA-AD15LDKOR3/4JE	15L	M22X150	3/4"	49,5	33,5	32	27	250
DA-AD18LDKOR3/8JE	18L	M26X150	3/8"	42,0	30,0	24	32	400
DA-AD18LDKOR1/2JE	18L	M26X150	1/2"	44,5	30,5	27	32	400
DA-AD18LDKOR3/4JE	18L	M26X150	3/4"	45,0	29,0	32	32	250
DA-AD22LDKOR1/2JE	22L	M30X200	1/2"	46,5	32,5	30	36	250
DA-AD22LDKOR3/4JE	22L	M30X200	3/4"	47,5	31,5	32	36	250
DA-AD28LDKOR1JE	28L	M36X200	1"	52,0	34,0	41	41	250
DA-AD35LDKOR11/4JE	35L	M45X200	1"1/4	63,5	39,5	50	50	250
DA-AD42LDKOR11/2JE	42L	M52X200	1"1/2	63,5	43,5	55	60	250
DA-ADO6SDKOR1/4JE	6S	M14X150	1/4"	39,0	27,0	19	17	800
DA-ADO8SDKOR1/4JE	8S	M16X150	1/4"	40,5	28,5	19	19	800
DA-AD10SDKOR3/8JE	10S	M18X150	3/8"	43,0	31,0	22	22	800
DA-AD12SDKOR3/8JE	12S	M20X150	3/8"	45,0	33,0	22	24	630
DA-AD12SDKOR1/2JE	12S	M20X150	1/2"	48,0	34,0	27	24	630
DA-AD14SDKOR1/2JE	14S	M22X150	1/2"	48,0	36,5	27	27	630
DA-AD16SDKOR3/8JE	16S	M24X150	3/8"	49,0	37,0	27	30	630
DA-AD16SDKOR1/2JE	16S	M24X150	1/2"	49,5	35,5	27	30	630
DA-AD16SDKOR3/4JE	16S	M24X150	3/4"	51,5	35,5	32	30	420
DA-AD20SDKOR1/2JE	20S	M30X200	1/2"	54,5	40,5	32	36	420
DA-AD20SDKOR3/4JE	20S	M30X200	3/4"	56,0	40,0	32	36	420
DA-AD20SDKOR1JE	20S	M30X200	1"	58,0	40,0	41	36	420
DA-AD25SDKOR3/4JE	25S	M36X200	3/4"	60,0	44,0	36	46	420
DA-AD25SDKOR1JE	25S	M36X200	1"	62,0	44,0	41	46	420
DA-AD30SDKOR1JE	30S	M42X200	1"	68,0	50,0	46	50	420
DA-AD30SDKOR11/4JE	30S	M42X200	1"1/4	66,0	46,0	50	50	420
DA-AD38SDKOR11/2JE	38S	M52X200	1"1/2	74,5	52,5	55	60	420



COUDE ORIENTABLE MALE BSPP

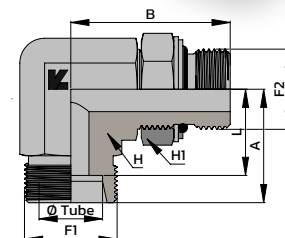
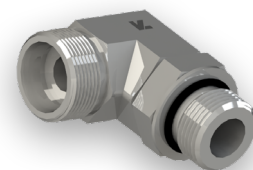

Référence	Ø Tube (mm)	F1	F2	A	B	L	H	H1	PN (bar)
DA-CMG06LR1/8	6L	M12X150	1/8"	21,0	26,5	14,0	11	14	315
DA-CMG06LR1/4	6L	M12X150	1/4"	21,0	37,0	14,0	-	19	315
DA-CMG08LR1/4	8L	M14X150	1/4"	23,0	32,0	16,0	14	19	315
DA-CMG08LR3/8	8L	M14X150	3/8"	24,0	37,0	17,0	19	22	315
DA-CMG08LR1/2	8L	M14X150	1/2"	26,0	43,0	19,0	22	27	315
DA-CMG10LR1/4	10L	M16X150	1/4"	24,0	34,0	17,0	19	19	315
DA-CMG10LR3/8	10L	M16X150	3/8"	24,0	37,0	17,0	19	22	250
DA-CMG10LR1/2	10L	M16X150	1/2"	26,0	43,0	19,0	22	27	250
DA-CMG12LR1/4	12L	M18X150	1/4"	26,0	36,0	19,0	19	19	250
DA-CMG12LR3/8	12L	M18X150	3/8"	26,0	37,0	19,0	19	22	250
DA-CMG12LR1/2	12L	M18X150	1/2"	26,0	43,0	19,0	22	27	250
DA-CMG15LR3/8	15L	M22X150	3/8"	28,0	38,0	21,0	22	22	250
DA-CMG15LR1/2	15L	M22X150	1/2"	28,0	43,0	21,0	22	27	250
DA-CMG15LR3/4	15L	M22X150	3/4"	35,0	55,0	28,0	27	36	250
DA-CMG18LR1/2	18L	M26X150	1/2"	31,0	49,0	23,5	27	27	250
DA-CMG22LR1/2	22L	M30X200	1/2"	35,0	49,0	27,5	30	27	160
DA-CMG22LR3/4	22L	M30X200	3/4"	35,0	49,0	28,0	30	36	160
DA-CMG22LR1	22L	M30X200	1"	35,0	52,0	28,0	32	41	160
DA-CMG28LR1	28L	M36X200	1"	38,0	59,0	30,5	36	41	160
DA-CMG35LR1.1/4	35L	M45X200	1"1/4	48,0	65,0	37,5	50	50	160
DA-CMG42LR1.1/2	42L	M52X200	1"1/2	51,0	66,0	38,0	50	55	160



DA-CMG06SR1/4	6S	M14X150	1/4"	22,5	32,0	15,5	14	19	315
DA-CMG08SR1/4	8S	M16X150	1/4"	25,0	36,0	18,0	19	19	315
DA-CMG10SR3/8	10S	M18X150	3/8"	25,0	38,0	18,0	19	22	250
DA-CMG12SR3/8	12S	M20X150	3/8"	29,5	38,0	22,0	22	22	250
DA-CMG12SR1/2	12S	M20X150	1/2"	29,5	41,5	22,0	27	27	250
DA-CMG14SR1/2	14S	M22X150	1/2"	29,5	44,0	22,0	27	27	250
DA-CMG16SR3/8	16S	M24X150	3/8"	-	-	-	-	-	250
DA-CMG16SR1/2	16S	M24X150	1/2"	33,5	49,0	25,0	27	27	250
DA-CMG16SR3/4	16S	M24X150	3/4"	34,5	51,0	25,0	27	36	250
DA-CMG20SR1/2	20S	M30X200	1/2"	38,0	49,0	27,5	27	27	250
DA-CMG20SR3/4	20S	M30X200	3/4"	38,5	51,0	28,0	33	36	250
DA-CMG25SR1JE	25S	M36X200	1"	38,0	57,0	30,0	41	41	250
DA-CMG30SR1.1/4	30S	M42X200	1"1/4	49,5	64,0	36,0	48	50	160
DA-CMG38SR1.1/2	38S	M52X200	1"1/2	50,0	69,0	34,0	48	55	160

COUDE 45° ORIENTABLE MALE BSPP

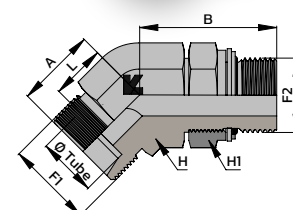
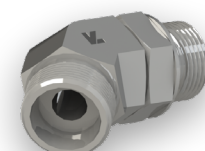

Référence	Ø Tube (mm)	F1	F2	A	B	L	H	H1	PN (bar)
DA-CM45G06LR1/8	6L	M12X150	1/8"	16,0	20,0	14,0	14	14	315
DA-CM45G08LR1/4	8L	M14X150	1/4"	21,0	32,0	14,0	14	17	315
DA-CM45G10LR1/4	10L	M16X150	1/4"	19,0	34,0	11,5	19	19	315
DA-CM45G10LR3/8	10L	M16X150	3/8"	-	-	-	-	-	315
DA-CM45G12LR3/8	12L	M18X150	3/8"	24,0	37,0	17,0	19	22	250
DA-CM45G12LR1/2	12L	M18X150	1/2"	21,0	44,0	14,0	27	27	250
DA-CM45G15LR1/2	15L	M22X150	1/2"	24,0	39,0	21,0	22	27	250
DA-CM45G18LR1/2	18L	M26X150	1/2"	24,0	45,0	16,5	27	27	250
DA-CM45G22LR3/4	22L	M30X200	3/4"	26,0	50,0	18,5	30	36	160
DA-CM45G28LR1"	28L	M36X200	1"	38,0	53,0	30,5	33	41	160
DA-CM45G16SR1/2	16S	M24X150	1/2"	24,0	44,0	15,5	27	27	250



TE ORIENTABLE MALE BSPP

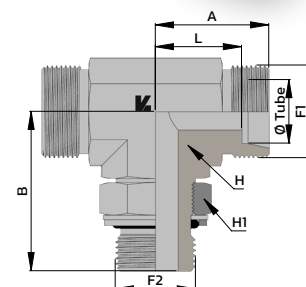
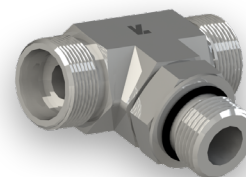

Référence	Ø Tube (mm)	F1	F2	A	B	L	H	H1	PN (bar)
DA-TMG10LR1/4	10L	M16X150	1/4"	24,0	34,0	17,0	19	19	315
DA-TMG12LR1/4	12L	M18X150	1/4"	26,0	34,0	19,0	19	19	250
DA-TMG12LR3/8	12L	M18X150	3/8"	24,0	37,0	17,0	19	22	250
DA-TMG15LR1/2	15L	M22X150	1/2"	28,0	43,0	21,0	22	27	250
DA-TMG18LR1/2	18L	M26X150	1/2"	31,0	47,0	23,5	27	27	250
DA-TMG22LR1	22L	M30X200	1"	35,0	52,0	27,5	33	41	160
DA-TMG16SR1/2	16S	M24X150	1/2"	-	-	-	-	-	250



TE ORIENTABLE RENVERSE MALE BSPP



Référence	Ø Tube (mm)	F1	F2	A	B	L	L1	H	H1	PN (bar)
DA-TMGR10LR1/4	10L	M16X150	1/4"	54,0	22,0	15,0	32,0	14	19	315
DA-TMGR10LR1/4	12L	M18X150	3/8"	63,0	26,0	19,0	37,0	22	19	315
DA-TMGR15LR1/2	15L	M22X150	1/2"	71,0	28,0	21,0	43,0	22	27	250
DA-TMGR16SR1/2	16S	M24X150	1/2"	80,0	33,0	24,5	47,0	27	27	250

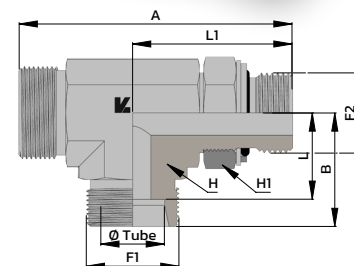
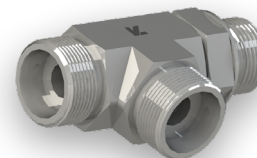



BANJO BSPP JE

Référence	Ø Tube (mm)	F1	F1	A	B	L	H	H1	PN (bar)
DA-BJE06LR1/8	6L	M12X150	1/8"	32,5	19,0	12,0	17	17	315
DA-BJE08LR1/4	8L	M14X150	1/4"	39,0	21,0	14,5	22	19	315
DA-BJE10LR1/4	10L	M16X150	1/4"	42,0	22,5	15,5	22	19	315
DA-BJE12LR3/8	12L	M18X150	3/8"	48,0	25,0	18,0	27	24	315
DA-BJE15LR1/2	15L	M22X150	1/2"	51,5	29,0	22,0	32	30	315
DA-BJE18LR1/2	18L	M26X150	1/2"	58,0	29,0	21,5	32	30	315
DA-BJE22LR3/4	22L	M30X200	3/4"	60,0	34,0	26,5	41	36	160
DA-BJE28LR1	28L	M36X200	1"	77,0	38,5	31,0	50	46	160
DA-BJE35LR1.1/4	35L	M45X200	1"1/4	85,5	45,5	35,0	60	55	160
DA-BJE42LR1.1/2	42L	M52X200	1"1/2	97,5	50,5	39,5	70	60	160
DA-BJE06SR1/4	6S	M14X150	1/4"	37,0	23,5	16,5	22	19	630
DA-BJE08SR1/4	8S	M16X150	1/4"	37,0	23,5	16,5	22	19	630
DA-BJE10SR3/8	10S	M18X150	3/8"	42,0	26,0	18,5	27	24	630
DA-BJE12SR3/8	12S	M20X150	3/8"	42,0	26,0	18,5	27	24	630
DA-BJE14SR1/2	14S	M22X150	1/2"	51,5	31,0	23,0	32	30	630
DA-BJE16SR1/2	16S	M24X150	1/2"	51,5	31,0	22,5	32	30	400
DA-BJE20SR3/4	20S	M30X200	3/4"	60,0	36,0	25,5	41	36	400
DA-BJE25SR1	25S	M36X200	1"	73,4	42,5	31,5	50	46	400
DA-BJE30SR1.1/4	30S	M42X200	1"1/4	85,5	49,5	36,0	60	55	400
DA-BJE38SR1.1/2	38S	M52X200	1"1/2	97,5	56,5	40,5	70	60	315

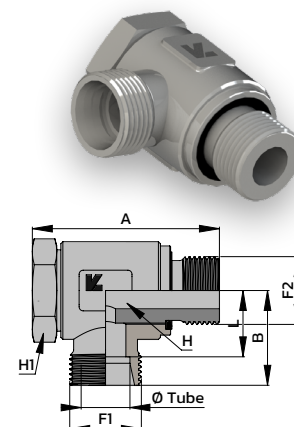

BANJO BSPP JE COMPLET / SERIE LL



Référence	Ø Tube (mm)	F1	F1	A	B	L	H	H1	PN (bar)
DA-BJE04LLR1/8C-ZN	4LL	M8X100	1/8"	26,5	18,0	14,0	17	17	100
DA-BJE06LLR1/8C-ZN	6LL	M10X100	1/8"	26,5	18,0	12,5	17	17	100
DA-BJE08LLR1/8C-ZN	8LL	M12X100	1/8"	26,5	19,0	13,5	17	17	100

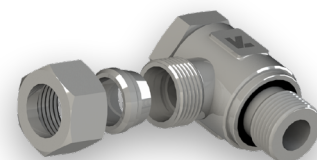

BANJO DOUBLE BSPP JE



Référence	Ø Tube (mm)	F1	F2	A	B	L	H	H1	PN (bar)
DA-BDJE06LR1/8	6L	M12X150	1/8"	26,5	19,0	12,0	17	17	315
DA-BDJE08LR1/4	8L	M14X150	1/4"	37,0	21,5	14,5	22	19	315
DA-BDJE10LR1/4-ZN	10L	M16X150	1/4"	37,0	22,5	15,5	22	19	315
DA-BDJE12LR3/8	12L	M18X150	3/8"	42,0	25,0	18,0	27	24	315
DA-BDJE15LR1/2	15L	M22X150	1/2"	51,5	29,0	22,0	32	30	315
DA-BDJE08SR1/4	8S	M16X150	1/4"	37,0	23,5	16,5	22	19	630
DA-BDJE12SR3/8	12S	M20X150	3/8"	42,0	26,0	18,5	27	24	630
DA-BDJE16SR1/2	16S	M24X150	1/2"	51,5	31,0	22,5	32	30	400
DA-BDJE20SR3/4	20S	M30X200	3/4"	60,0	36,0	25,5	41	36	400
DA-BDJE25SR1	25S	M36X200	1"	73,5	42,5	31,5	50	46	400
DA-BDJE30SR1.1/4	30S	M42X200	1"1/4	85,5	49,5	36,0	60	55	400

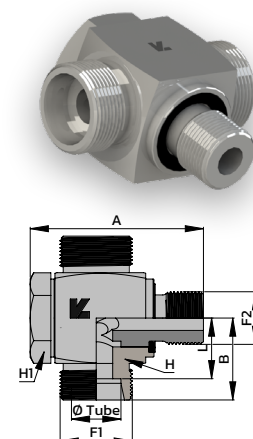

UNION MALE BSPT



Référence	Ø Tube (mm)	F1	F2	A	B	L	H	PN (bar)
DA-UMC06L1/8	6L	M12X150	1/8"	24,0	10,0	7,0	12	315
DA-UMC06L1/4	6L	M12X150	1/4"	28,0	13,0	8,0	17	315
DA-UMC08L1/8	8L	M14X150	1/8"	25,0	10,0	8,0	14	315
DA-UMC08L1/4	8L	M14X150	1/4"	28,0	13,0	8,0	17	315
DA-UMC08L3/8	8L	M14X150	3/8"	29,0	13,0	9,0	19	315
DA-UMC08L1/2	8L	M14X150	1/2"	32,0	16,0	9,0	22	315
DA-UMC10L1/8	10L	M16X150	1/8"	26,0	10,0	9,0	17	315
DA-UMC10L1/4	10L	M16X150	1/4"	29,0	13,0	9,0	17	315
DA-UMC10L3/8	10L	M16X150	3/8"	32,0	15,0	10,0	19	315
DA-UMC10L1/2	10L	M16X150	1/2"	31,0	14,0	10,0	22	315
DA-UMC12L1/4	12L	M18X150	1/4"	30,0	13,0	10,0	19	315
DA-UMC12L3/8	12L	M18X150	3/8"	30,0	13,0	10,0	19	315
DA-UMC12L1/2	12L	M18X150	1/2"	37,0	20,0	10,0	22	315
DA-UMC15L3/8	15L	M22X150	3/8"	31,0	13,0	11,0	24	315
DA-UMC15L1/2	15L	M22X150	1/2"	32,0	14,0	11,0	24	315
DA-UMC18L3/8	18L	M26X150	3/8"	32,0	13,0	11,5	27	315
DA-UMC18L1/2	18L	M26X150	1/2"	35,0	16,0	11,5	27	315
DA-UMC18L3/4	18L	M26X150	3/4"	37,0	18,0	11,5	32	315
DA-UMC22L3/4	22L	M30X200	3/4"	39,0	18,0	13,5	32	160
DA-UMC22L1	22L	M30X200	1"	40,0	18,0	14,5	36	160
DA-UMC28L1	28L	M36X200	1"	40,0	18,0	14,5	41	160
DA-UMC35L1.1/4	35L	M45X200	1"1/4	45,0	20,0	14,5	46	160
DA-UMC42L1.1/2	42L	M52X200	1"1/2	49,0	22,0	16,0	55	160

DA-UMC06S1/4	6S	M14X150	1/4"	31,0	12,0	12,0	17	400
DA-UMC08S1/4	8S	M16X150	1/4"	32,0	12,0	13,0	17	400
DA-UMC10S1/4	10S	M18X150	1/4"	32,0	12,0	12,5	19	400
DA-UMC10S3/8	10S	M18X150	3/8"	32,0	12,0	12,5	19	400
DA-UMC12S1/4	12S	M20X150	1/4"	34,0	12,0	14,5	22	400
DA-UMC12S3/8	12S	M20X150	3/8"	34,0	12,0	14,5	22	400
DA-UMC12S1/2	12S	M20X150	1/2"	36,0	14,0	14,5	22	400
DA-UMC14S3/8	14S	M22X150	3/8"	36,0	12,0	16,0	24	400
DA-UMC14S1/2	14S	M22X150	1/2"	38,0	14,0	16,0	24	400
DA-UMC16S3/8	16S	M24X150	3/8"	37,0	12,0	17,5	27	400
DA-UMC16S1/2	16S	M24X150	1/2"	39,0	14,0	17,5	27	400
DA-UMC20S1/2	20S	M30X200	1/2"	42,0	14,0	17,5	32	400
DA-UMC20S3/4	20S	M30X200	3/4"	44,0	16,0	17,5	32	400
DA-UMC25S3/4	25S	M36X200	3/4"	48,0	16,0	20,0	41	400
DA-UMC25S1	25S	M36X200	1"	50,0	18,0	20,0	41	400
DA-UMC30S1	30S	M42X200	1"	51,0	18,0	19,5	46	400
DA-UMC30S1.1/4	30S	M42X200	1"1/4	53,0	20,0	19,5	46	400
DA-UMC38S1.1/2	38S	M52X200	1"1/2	60,0	22,0	22,0	55	315

UNION MALE BSPT COMPLETE / SERIE LL

Référence	Ø Tube (mm)	F1	F2	A	B	L	H	PN (bar)
DA-UMC04LLR1/8C-ZN	4LL	M8X100	1/8"	20,0	9,0	7,0	11	100
DA-UMC06LLR1/8C-ZN	6LL	M10X100	1/8"	20,0	8,0	6,5	11	100
DA-UMC08LLR1/8C-ZN	8LL	M12X100	1/8"	22,0	9,0	7,5	12	100
DA-UMC08LLR1/4C-ZN	8LL	M12X100	1/4"	26,0	12,0	13,5	14	100
DA-UMC10LLR1/4C-ZN	10LL	M14X100	1/4"	26,0	12,0	8,5	17	100
DA-UMC12LLR1/4C-ZN	12LL	M16X100	1/4"	26,0	12,0	8,0	17	100
DA-UMC12LLR3/8C-ZN	12LL	M16X100	3/8"	26,0	12,0	8,0	17	100

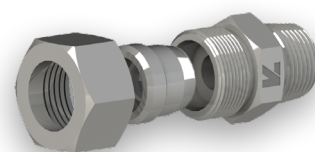

ADAPTATEUR TOURNANT DKO / BSPT



Référence	Ø Tube (mm)	F1	F2	A	B	H	H1	PN (bar)
DA-AD10LDKOR1/4K	10L	M16X150	1/4"	36,0	12,5	14	19	315
DA-AD10LDKOR3/8K	10L	M16X150	3/8"	36,5	13,0	19	19	315
DA-AD12LDKOR1/4K	12L	M18X150	1/4"	37,5	12,5	17	22	315
DA-AD12LDKOR3/8K	12L	M18X150	3/8"	38,0	13,0	17	22	315
DA-AD12LDKOR1/2K	12L	M18X150	1/2"	41,5	17,0	22	22	315
DA-AD15LDKOR3/8K	15L	M22X150	3/8"	39,5	13,0	19	27	315
DA-AD15LDKOR1/2K	15L	M22X150	1/2"	43,5	17,0	22	27	315

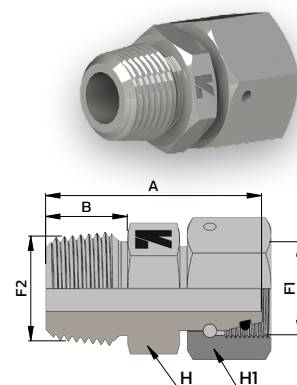

COUDE MALE BSPT



Référence	Ø Tube (mm)	F1	F2	A	B	L	H	PN (bar)
DA-CMC06LR1/8	6L	M12X150	1/8"	19,0	20,0	12,0	12	315
DA-CMC06LR1/4	6L	M12X150	1/4"	21,0	26,0	14,0	12	315
DA-CMC08LR1/8	8L	M14X150	1/8"	21,0	26,0	14,0	12	315
DA-CMC08LR1/4	8L	M14X150	1/4"	21,0	26,0	14,0	14	315
DA-CMC08LR3/8	8L	M14X150	3/8"	24,0	28,0	17,0	19	315
DA-CMC08LR1/2	8L	M14X150	1/2"	26,5	34,0	19,0	19	315
DA-CMC10LR1/8	10L	M16X150	1/8"	22,0	26,0	15,0	17	315
DA-CMC10LR1/4	10L	M16X150	1/4"	22,0	27,0	15,0	17	315
DA-CMC10LR3/8	10L	M16X150	3/8"	24,0	28,0	17,0	19	315
DA-CMC10LR1/2	10L	M16X150	1/2"	28,0	34,0	21,0	19	315
DA-CMC12LR1/4	12L	M18X150	1/4"	24,0	27,0	17,0	19	315
DA-CMC12LR3/8	12L	M18X150	3/8"	24,0	28,0	17,0	19	315
DA-CMC12LR1/2	12L	M18X150	1/2"	28,0	34,0	21,0	19	315
DA-CMC15LR3/8	15L	M22X150	3/8"	28,0	28,0	21,0	19	315
DA-CMC15LR1/2	15L	M22X150	1/2"	28,0	34,0	21,0	22	315
DA-CMC18LR1/2	18L	M22X150	1/2"	31,0	36,0	23,5	24	315
DA-CMC18LR3/4	18L	M22X150	3/4"	33,0	42,0	25,5	27	315
DA-CMC22LR3/4	22L	M30X200	3/4"	35,0	42,0	27,5	27	160
DA-CMC28LR1	28L	M36X200	1"	38,0	48,0	30,5	36	160
DA-CMC42LR1.1/2	42L	M52X200	1"1/2	51,0	61,0	40,0	50	160

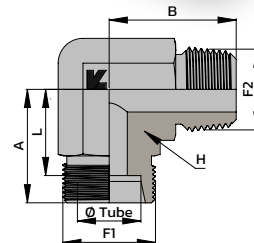
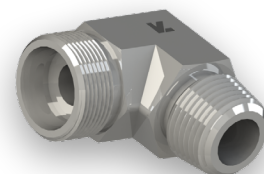

DA-CMC06SR1/4	6S	M14X150	1/4"	23,0	26,0	16,0	12	400
DA-CMC08SR1/4	8S	M16X150	1/4"	24,0	27,0	17,0	14	400
DA-CMC10SR3/8	10S	M18X150	3/8"	25,0	28,0	17,5	19	400
DA-CMC12SR3/8	12S	M20X150	3/8"	29,0	28,0	21,5	22	400
DA-CMC12SR1/2	12S	M20X150	1/2"	30,0	32,0	22,5	19	400
DA-CMC14SR3/8	14S	M22X150	3/8"	30,0	32,0	22,0	19	400
DA-CMC14SR1/2	14S	M22X150	1/2"	30,0	32,0	22,0	19	400
DA-CMC16SR3/8	16S	M24X150	3/8"	33,0	32,0	24,5	24	400
DA-CMC16SR1/2	16S	M24X150	1/2"	33,0	32,0	24,5	24	400
DA-CMC20SR1/2	20S	M30X200	1/2"	37,0	32,0	26,5	27	315
DA-CMC20SR3/4	20S	M30X200	3/4"	37,0	42,0	26,5	27	315
DA-CMC25SR3/4	25S	M36X200	3/4"	42,0	42,0	30,0	36	315
DA-CMC25SR1	25S	M36X200	1"	42,0	48,0	30,0	36	315
DA-CMC30SR1	30S	M42X200	1"	49,0	48,0	35,5	41	315
DA-CMC38SR1.1/2	38S	M52X200	1"1/2	57,0	61,0	41,0	50	315

COUDE MALE BSPT COMPLET / SERIE LL



Référence	Ø Tube (mm)	F1	F2	A	B	L	H	PN (bar)
DA-CMC04LLR1/8C-ZN	4LL	M8X100	1/8"	15,0	17,0	11,0	11	100
DA-CMC06LLR1/8C-ZN	6LL	M10X100	1/8"	15,0	17,0	9,5	11	100
DA-CMC08LLR1/8C-ZN	8LL	M12X100	1/8"	17,0	20,0	11,5	12	100
DA-CMC10LLR1/4C-ZN	10LL	M14X100	1/4"	18,0	23,0	12,5	14	100
DA-CMC12LLR1/4C-ZN	12LL	M16X100	1/4"	19,0	23,0	13,0	17	100

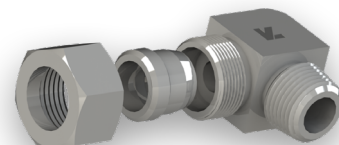

TE MALE BSPT



Référence	Ø Tube (mm)	F1	F2	A	B	L	H	PN (bar)
DA-TMC06LR1/8	6L	M12X150	1/8"	19,0	20,0	12,0	12	315
DA-TMC08LR1/4	8L	M14X150	1/4"	21,0	26,0	14,0	12	315
DA-TMC10LR1/4	10L	M16X150	1/4"	22,0	27,0	15,0	14	315
DA-TMC12LR3/8	12L	M18X150	3/8"	24,0	28,0	17,0	19	315
DA-TMC15LR1/2	15L	M22X150	1/2"	28,0	34,0	21,0	22	315
DA-TMC18LR1/2	18L	M26X150	1/2"	31,0	36,0	23,5	24	315
<hr/>								
DA-TMC06SR1/4	6S	M14X150	1/4"	23,0	26,0	16,0	12	400
DA-TMC08SR1/4	8S	M16X150	1/4"	24,0	27,0	17,0	14	400
DA-TMC10SR3/8	10S	M18X150	3/8"	25,0	28,0	17,5	17	400
DA-TMC12SR3/8	12S	M20X150	3/8"	29,0	28,0	21,5	17	400
DA-TMC16SR1/2	16S	M24X150	1/2"	33,0	32,0	24,5	24	400

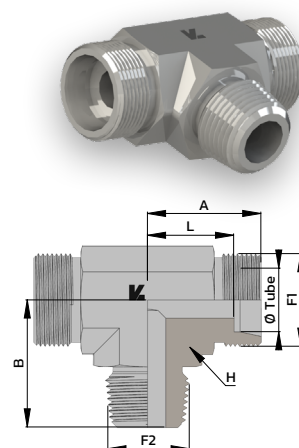

TE RENVERSE MALE BSPT



Référence	Ø Tube (mm)	F1	F2	A	B	L	H	PN (bar)
DA-TMRC06LR1/8	6L	M12X150	1/8"	39,0	19,0	12,0	12	315
DA-TMRC08LR1/4	8L	M14X150	1/4"	47,0	21,0	14,0	12	315
DA-TMRC10LR1/4	10L	M16X150	1/4"	49,0	22,0	15,0	14	315
DA-TMRC12LR3/8	12L	M18X150	3/8"	52,0	24,0	17,0	17	315
<hr/>								
DA-TMRC06SR1/4	6S	M14X150	1/4"	49,0	23,0	16,0	12	400
DA-TMRC08SR1/4	8S	M16X150	1/4"	51,0	24,0	17,0	14	400
DA-TMRC10SR3/8	10S	M18X150	3/8"	53,0	25,0	17,5	17	400
DA-TMRC12SR3/8	12S	M20X150	3/8"	57,0	29,0	21,5	17	400
DA-TMRC16SR1/2	16S	M24X150	1/2"	65,0	33,0	24,5	24	400

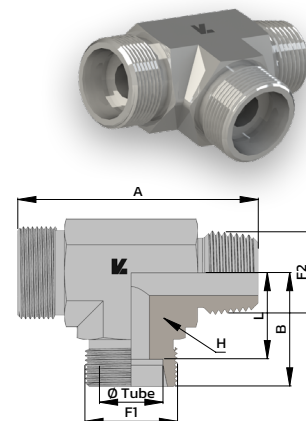

UNION MALE METRIQUE JE



Référence	Ø Tube (mm)	F1	F2	A	B	L	H	PN (bar)
DA-UM06LM10JE	6L	M12X150	M10X100	23,5	8,0	8,5	14	500
DA-UM06LM12JE	6L	M12X150	M12X150	29,0	12,0	10,0	17	500
DA-UM06LM14JE	6L	M12X150	M14X150	28,5	12,0	9,5	19	500
DA-UM06LM18JE	6L	M12X150	M18X150	30,0	12,0	11,0	24	400
DA-UM08LM10JE	8L	M14X150	M10X100	25,0	8,0	10,0	14	500
DA-UM08LM12JE	8L	M14X150	M12X150	29,0	12,0	10,0	17	500
DA-UM08LM14JE	8L	M14X150	M14X150	30,0	12,0	11,0	19	500
DA-UM08LM16JE	8L	M14X150	M16X150	30,0	12,0	11,0	22	420
DA-UM08LM18JE	8L	M14X150	M18X150	30,0	12,0	11,0	24	400
DA-UM10LM12JE	10L	M16X150	M12X150	30,0	12,0	11,0	17	315
DA-UM10LM14JE	10L	M16X150	M14X150	30,0	12,0	11,0	19	500
DA-UM10LM16JE	10L	M16X150	M16X150	31,5	12,0	12,5	22	420
DA-UM10LM18JE	10L	M16X150	M18X150	31,5	12,0	12,5	24	400
DA-UM10LM22JE	10L	M16X150	M22X150	35,0	14,0	14,0	27	400
DA-UM12LM12JE	12L	M18X150	M12X150	30,0	9,0	14,0	19	400
DA-UM12LM14JE	12L	M18X150	M14X150	30,0	12,0	11,0	19	400
DA-UM12LM16JE	12L	M18X150	M16X150	31,5	12,0	12,5	22	400
DA-UM12LM18JE	12L	M18X150	M18X150	32,5	12,0	13,5	24	400
DA-UM12LM22JE	12L	M18X150	M22X150	35,0	14,0	14,0	27	400
DA-UM15LM12JE	15L	M22X150	M12X150	32,0	12,0	13,0	24	400
DA-UM15LM14JE	15L	M22X150	M14X150	33,0	12,0	14,0	24	400
DA-UM15LM16JE	15L	M22X150	M16X150	32,0	12,0	13,0	24	400
DA-UM15LM18JE	15L	M22X150	M18X150	33,5	12,0	14,5	24	400
DA-UM15LM20JE	15L	M22X150	M20X150	34,5	14,0	13,5	27	400
DA-UM15LM22JE	15L	M22X150	M22X150	36,0	14,0	15,0	27	400
DA-UM15LM26JE	15L	M22X150	M26X150	-	-	-	-	250
DA-UM18LM18JE	18L	M26X150	M18X150	34,0	12,0	14,5	27	400
DA-UM18LM20JE	18L	M26X150	M20X150	36,0	14,0	14,5	27	400
DA-UM18LM22JE	18L	M26X150	M22X150	36,0	14,0	14,5	27	400
DA-UM18LM26JE	18L	M26X150	M26X150	40,0	16,0	16,5	32	250
DA-UM18LM33JE	18L	M26X150	M33X200	41,0	18,0	15,5	41	250
DA-UM22LM18JE	22L	M30X200	M18X150	35,5	12,0	16,0	32	250
DA-UM22LM22JE	22L	M30X200	M22X150	38,0	14,0	16,5	32	250
DA-UM22LM26JE	22L	M30X200	M26X150	40,0	16,0	16,5	32	250
DA-UM22LM33JE	22L	M30X200	M33x200	43,0	18,0	17,5	41	250
DA-UM28LM33JE	28L	M30X200	M33X200	43,0	18,0	17,5	41	250
DA-UM35LM42JE	35L	M45X200	M42X200	48,0	20,0	17,5	50	250
DA-UM42LM48JE	42L	M52X200	M48X200	52,0	22,0	19,0	55	250

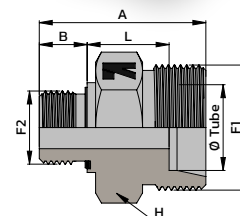
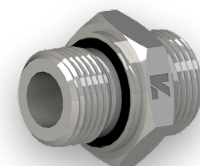

Suite à la page DIN 42

UNION MALE METRIQUE JE - Suite

Référence	Ø Tube (mm)	F1	F2	A	B	L	H	PN (bar)
DA-UM06SM12JE	6S	M14X150	M12X150	31,0	12,0	13,0	17	800
DA-UM08SM10JE	8S	M16X150	M10X100	30,0	8,0	15,0	19	800
DA-UM08SM12JE	8S	M16X150	M12X150	33,0	12,0	14,0	17	800
DA-UM08SM14JE	8S	M16X150	M14X150	34,0	12,0	15,0	19	800
DA-UM08SM16JE	8S	M16X150	M16X150	33,0	12,0	14,0	22	800
DA-UM10SM16JE	10S	M18X150	M16X150	35,0	12,0	15,0	22	800
DA-UM12SM14JE	12S	M20X150	M14X150	-	-	-	-	630
DA-UM12SM16JE	12S	M20X150	M16X150	36,5	12,0	16,0	22	630
DA-UM12SM18JE	12S	M20X150	M18X150	36,5	12,0	17,0	24	630
DA-UM12SM22JE	12S	M20X150	M22X150	39,0	14,0	17,5	27	630
DA-UM14SM20JE	14S	M22X150	M20X150	41,0	14,0	19,0	27	630
DA-UM16SM18JE	16S	M24X150	M18X150	38,5	12,0	19,0	27	630
DA-UM16SM22JE	16S	M24X150	M22X150	41,0	14,0	18,5	27	630
DA-UM20SM22JE	20S	M30X200	M22X150	45,0	14,0	20,5	32	420
DA-UM20SM27JE	20S	M30X200	M27X200	47,0	16,0	20,5	32	420
DA-UM25SM33JE	25S	M36X200	M33X200	53,0	18,0	23,0	41	420
DA-UM30SM42JE	30S	M42X200	M42X200	57,0	20,0	23,5	50	420
DA-UM38SM48JE	38S	M52X200	M48X200	64,0	22,0	26,0	55	420

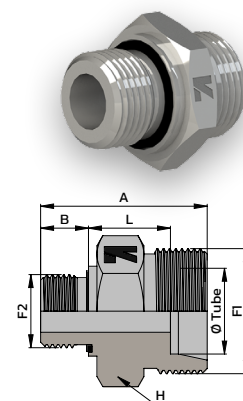
UNION MALE METRIQUE JE COMPLETE / SERIE LL

Référence	Ø Tube (mm)	F1	F2	A	B	L	H	PN (bar)
DA-UM04LLM08JEC-ZN	4LL	M8X100	M8X100	21,5	8,0	9,5	12	100
DA-UM06LLM10JEC-ZN	6LL	M10X100	M10X100	21,5	8,0	8,0	14	100
DA-UM08LLM10JEC-ZN	8LL	M12X100	M10X100	22,5	8,0	9,0	14	100

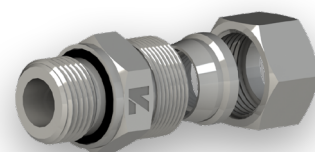

ADAPTATEUR TOURNANT DKO / METRIQUE JE



Référence	Ø Tube (mm)	F1	F2	A	L	H	H1	PN (bar)
DA-AD06LDKOM10JE	6L	M12X150	M10X100	32,5	24,5	14	14	500
DA-AD08LDKOM12JE	8L	M14X150	M12X150	38,0	26,0	17	17	500
DA-AD10LDKOM14JE	10L	M16X150	M14X150	39,0	27,0	19	19	500
DA-AD10LDKOM18JE	10S	M16X150	M18X150	39,0	27,0	24	19	400
DA-AD12LDKOM16JE	12L	M18X150	M16X150	42,0	30,0	22	22	400
DA-AD12LDKOM18JE	12L	M18X150	M18X150	41,0	29,0	24	22	400
DA-AD15LDKOM18JE	15L	M22X150	M18X150	43,0	31,0	24	27	400
DA-AD18LDKOM22JE	18L	M26X150	M22X150	44,5	30,5	27	32	400
DA-AD22LDKOM26JE	22L	M30X200	M26X150	48,5	32,5	32	36	250
DA-AD28LDKOM33JE	28L	M36X200	M33X200	53,0	35,0	41	41	250
DA-AD35LDKOM42JE	35L	M45X200	M42X200	62,5	42,5	50	50	250
DA-AD42LDKOM48JE	42L	M52X200	M48X200	68,5	46,5	55	60	250
DA-ADO6SDKOM12JE	6S	M14X150	M12X150	39,0	27,0	17	17	800
DA-ADO8SDKOM14JE	8S	M16X150	M14X150	41,5	29,5	19	19	800
DA-AD10SDKOM16JE	10S	M18X150	M16X150	44,0	32,0	22	22	800
DA-AD12SDKOM18JE	12S	M20X150	M18X150	46,0	34,0	24	24	630
DA-AD16SDKOM22JE	16S	M24X150	M22X150	50,0	36,0	27	30	630
DA-AD20SDKOM27JE	20S	M30X200	M27X200	59,0	43,0	32	36	420
DA-AD25SDKOM33JE	25S	M36X200	M33X200	66,0	48,0	41	46	420
DA-AD30SDKOM42JE	30S	M42X200	M42X200	71,0	51,0	50	50	420
DA-AD38SDKOM48JE	38S	M52X200	M48X200	82,0	60,0	55	60	420

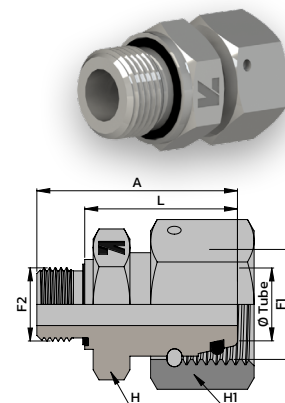

BANJO METRIQUE JE



Référence	Ø Tube (mm)	F1	F2	A	B	L	H	H1	PN (bar)
DA-BJE06LM10	6L	M12X150	M10X100	32,5	19,0	12,0	17	17	315
DA-BJE08LM12	8L	M14X150	M12X150	39,5	21,5	14,5	22	19	315
DA-BJE10LM14	10L	M16X150	M14X150	37,0	22,5	15,5	22	19	315
DA-BJE12LM16	12L	M18X150	M16X150	42,0	25,0	18,0	27	24	315
DA-BJE15LM18	15L	M22X150	M18X150	45,5	29,0	22,0	32	27	315
DA-BJE18LM22	18L	M26X150	M22X150	51,5	29,0	21,5	32	30	315
DA-BJE22LM26	22L	M30X200	M26X150	60,0	34,0	26,5	41	36	160
DA-BJE28LM33	28L	M36X200	M33X200	73,5	38,5	31,0	50	46	160
DA-BJE35LM42	35L	M45X200	M42X200	85,5	45,5	35,0	60	55	160
DA-BJE42LM48	42L	M52X200	M48X200	97,5	50,5	39,5	70	60	160
DA-BJE08SM14	8S	M16X150	M14X150	39,5	22,3	15,3	22	19	630
DA-BJE10SM16	10S	M18X150	M16X150	42,0	26,0	18,5	27	24	630
DA-BJE12SM18	12S	M20X150	M18X150	45,5	29,0	21,5	32	24	630
DA-BJE14SM20	14S	M22X150	M20X150	50,0	31,0	23,0	32	30	630
DA-BJE16SM22	16S	M24X150	M22X150	51,5	31,0	22,5	32	30	400
DA-BJE20SM27	20S	M30X200	M27X200	60,0	36,0	25,5	41	36	400
DA-BJE25SM33	25S	M36X200	M33X200	73,5	42,5	31,5	50	46	400
DA-BJE30SM42	30S	M42X200	M42X200	85,5	49,5	36,0	60	55	400
DA-BJE38SM48	38S	M52X200	M48X200	97,5	56,5	40,5	70	60	315
DA-BJE06LLM10C-ZN	6LL	M10X100	M10X100	26,5	18,0	12,5	17	17	100

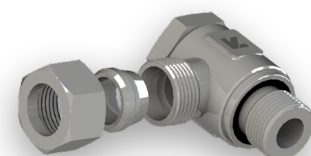
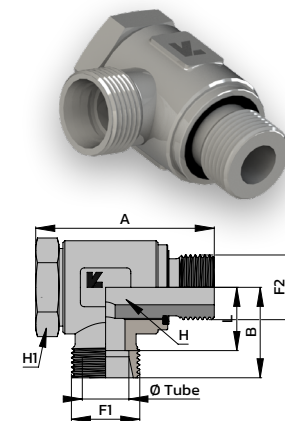



COUDE ORIENTABLE MALE METRIQUE DIN

Référence	Ø Tube (mm)	F1	F2	A	B	L	H	H1	PN (bar)
DA-CMM06LM10DIN	6L	M12X150	M10X100	21,0	27,0	14,0	14	14	315
DA-CMM06LM12DIN	6L	M12X150	M12X150	-	-	-	-	-	315
DA-CMM08LM10DIN	8L	M14X150	M10X100	21,0	27,5	14,0	14	14	315
DA-CMM08LM12DIN	8L	M14X150	M12X150	23,0	32,0	16,0	14	17	315
DA-CMM08LM14DIN	8L	M14X150	M14X150	24,0	33,5	17,0	14	19	315
DA-CMM10LM12DIN	10L	M16X150	M12X150	22,0	30,5	15,0	19	17	315
DA-CMM10LM14DIN	10L	M16X150	M14X150	24,0	35,0	17,0	19	19	315
DA-CMM10LM16DIN	10L	M16X150	M16X150	22,0	37,0	15,0	19	22	315
DA-CMM10LM18DIN	10L	M16X150	M18X150	24,0	41,0	17,0	19	24	315
DA-CMM12LM16DIN	12L	M18X150	M16X150	26,0	37,0	19,0	19	22	315
DA-CMM12LM18DIN	12L	M18X150	M18X150	26,0	41,0	19,0	19	24	315
DA-CMM15LM16DIN	15L	M22X150	M16X150	28,0	38,0	21,0	22	22	315
DA-CMM15LM18DIN	15L	M22X150	M18X150	28,0	37,0	21,0	22	24	315
DA-CMM15LM22DIN	15L	M22X150	M22X150	30,0	45,0	23,0	27	27	250
DA-CMM15LM22DJE*	15L	M22X150	M22X150	28,0	45,0	21,0	27	27	250
DA-CMM18LM18DIN	18L	M26X150	M18X150	31,0	41,0	23,5	27	24	315
DA-CMM18LM22DIN	18L	M26X150	M22X150	31,0	45,0	24,0	27	27	250
DA-CMM18LM26DIN	18L	M26X150	M26X150	31,0	51,0	23,5	27,0	36,0	160
DA-CMM22LM22DIN	22L	M30X200	M22X150	34,0	45,0	26,0	30	27	160
DA-CMM22LM26DIN	22L	M30X200	M26X150	35,0	50,0	27,5	30	36	160
DA-CMM28LM33DIN	28L	M36X200	M33X200	38,0	51,0	30,5	36	41	160
DA-CMM08SM14DIN	8S	M16X150	M14X150	24,0	36,0	17,0	19	19	400
DA-CMM10SM16DIN	10S	M18X150	M16X150	25,0	38,0	18,0	19	22	400
DA-CMM12SM18DIN	12S	M20X150	M18X150	29,0	43,0	22,0	22	24	400
DA-CMM16SM22DIN	16S	M24X150	M22X150	33,0	50,0	24,5	27	27	400

* Equipé d'un joint encastré

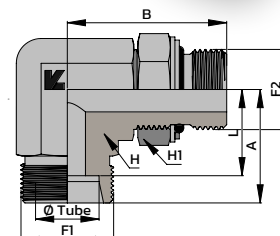
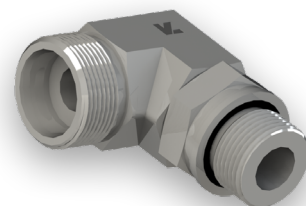

COUDE 45° ORIENTABLE MALE METRIQUE DIN



Référence	Ø Tube (mm)	F1	F2	A	B	L	H	H1	PN (bar)
DA-CM45M10LM14DIN	10L	M16X150	M14X150	19,0	33,0	12,0	19	19	315
DA-CM45M12LM16DIN	12L	M18X150	M16X150	21,0	33,0	14,0	19	22	315
DA-CM45M12LM18DIN	12L	M18X150	M18X150	24,0	38,5	17,0	19	24	315
DA-CM45M12LM22DIN	12L	M18X150	M22X150	24,0	42,0	17,0	27	27	315
DA-CM45M15LM18DIN	15L	M22X150	M18X150	24,0	41,0	17,0	22	24	315
DA-CM45M15LM22DIN	15L	M22X150	M22X150	24,0	42,0	17,0	27	27	250
DA-CM45M18LM22DIN	18L	M26X150	M22X150	24,0	42,0	16,5	27	27	250
DA-CM45M22LM22DIN	22L	M30X200	M22X150	26,0	42,0	18,5	30	27	160
DA-CM45M20SM27DIN	20S	M30X200	M27X200	27,0	51,0	16,0	30	32	250

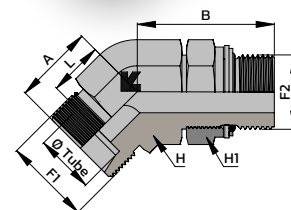
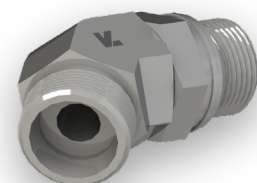

TE ORIENTABLE MALE METRIQUE DIN



Référence	Ø Tube (mm)	F1	F2	A	B	L	H	H1	PN (bar)
DA-TMM08LM12DIN	8L	M14X150	M12X150	23,0	32,0	16,0	14	17	315
DA-TMM08LM14DIN	8L	M14X150	M14X150	21,0	30,5	14,0	14	19	315
DA-TMM10LM14DIN	10L	M16X150	M14X150	22,0	33,5	15,0	19	19	315
DA-TMM12LM18DIN	12L	M18X150	M18X150	26,0	41,0	19,0	19	24	315

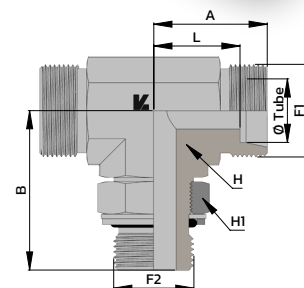
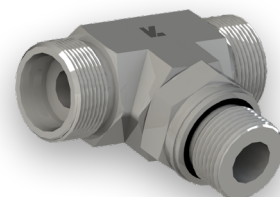

TE ORIENTABLE RENVERSE MALE METRIQUE DIN



Référence	Ø Tube (mm)	F1	F2	A	B	L	L1	H	H1	PN (bar)
DA-TMRM06LM10DIN	6L	M12X150	M10X100	48,0	21,0	14,0	27,0	14	14	315

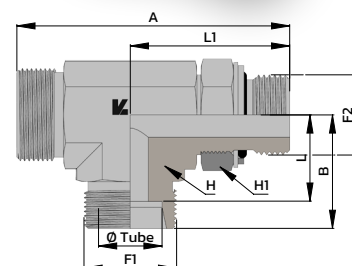
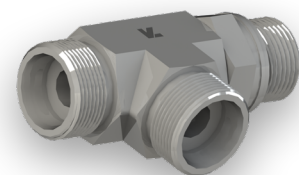

UNION MALE METRIQUE ISO

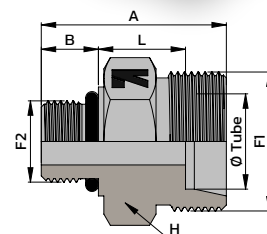
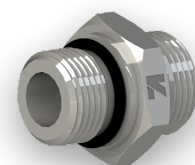

Référence	Ø Tube (mm)	F1	F2	A	B	L	H	PN (bar)
DA-UM06LM10ISO	6L	M12X150	M10X100	24,0	8,5	8,5	14	500
DA-UM06LM14ISO	6L	M12X150	M14X150	28,0	11,0	10,0	19	500
DA-UM08LM10ISO	8L	M14X150	M10X100	26,0	9,0	10,0	17	500
DA-UM08LM12ISO	8L	M14X150	M12X150	28,0	11,0	10,0	17	500
DA-UM08LM14ISO	8L	M14X150	M14X150	29,0	11,0	11,0	19	500
DA-UM08LM16ISO	8L	M14X150	M16X150	33,5	11,5	15,0	22	500
DA-UM08LM18ISO	8L	M14X150	M18X150	31,0	12,5	11,5	24	500
DA-UM08LM22ISO	8L	M14X150	M22X150	32,0	13,0	12,0	27	500
DA-UM10LM12ISO	10L	M16X150	M12X150	29,0	11,0	11,0	17	500
DA-UM10LM14ISO	10L	M16X150	M14X150	29,0	11,0	11,0	19	500
DA-UM10LM16ISO	10L	M16X150	M16X150	31,0	11,5	12,5	22	500
DA-UM10LM18ISO	10L	M16X150	M18X150	32,0	12,5	12,5	24	500
DA-UM10LM22ISO	10L	M16X150	M22X150	33,5	13,0	13,5	27	500
DA-UM10LM33ISO	10L	M16X150	M33X150	39,0	16,0	15,0	41	400
DA-UM12LM12ISO	12L	M18X150	M12X150	31,5	11,0	13,5	19	400
DA-UM12LM14ISO	12L	M18X150	M14X150	30,5	11,0	12,5	19	400
DA-UM12LM16ISO	12L	M18X150	M16X150	31,0	11,5	12,5	22	400
DA-UM12LM18ISO	12L	M18X150	M18X150	32,5	12,5	13,0	24	400
DA-UM12LM22ISO	12L	M18X150	M22X150	33,0	13,0	13,0	27	400
DA-UM15LM14ISO	15L	M22X150	M14X150	32,0	11,0	14,0	22	400
DA-UM15LM16ISO	15L	M22X150	M16X150	32,0	11,5	13,5	24	400
DA-UM15LM18ISO	15L	M22X150	M18X150	33,0	12,5	13,5	24	400
DA-UM15LM20ISO	15L	M22X150	M20X150	-	-	-	-	400
DA-UM15LM22ISO	15L	M22X150	M22X150	35,0	13,0	15,0	27	400
DA-UM15LM27ISO	15L	M22X150	M27X200	38,0	16,0	15,0	32	400
DA-UM18LM18ISO	18L	M26X150	M18X150	35,0	12,5	14,0	27	400
DA-UM18LM22ISO	18L	M26X150	M22X150	35,0	13,0	14,5	27	400
DA-UM18LM27ISO	18L	M26X150	M27X200	38,0	18,5	12,0	32	250
DA-UM18LM33ISO	18L	M26X150	M33X200	-	-	-	-	250
DA-UM22LM18ISO	18L	M26X150	M18X150	36,0	12,5	16,5	32	250
DA-UM22LM22ISO	22L	M30X200	M22X150	37,0	13,0	16,5	32	250
DA-UM22LM26ISO	22L	M30X200	M26X150	40,0	16,0	16,5	32	250
DA-UM22LM27ISO	22L	M30X200	M27X200	40,0	16,0	16,5	32	250
DA-UM22LM30ISO	22L	M30X200	M30X200	42,0	16,0	18,5	36	250
DA-UM22LM33ISO	22L	M30X200	M33X200	40,0	16,0	16,5	41	250
DA-UM28LM27ISO	28L	M36X200	M27X200	41,0	16,0	17,5	41	250
DA-UM28LM33ISO	28L	M36X200	M33X200	41,0	16,0	17,5	41	250
DA-UM35LM42ISO	35L	M45X200	M42X200	44,0	16,0	17,5	50	250
DA-UM06SM12ISO	6S	M14X150	M12X150	31,0	11,0	13,0	17	800
DA-UM08SM14ISO	8S	M16X150	M14X150	33,0	11,0	15,0	19	800
DA-UM10SM16ISO	10S	M18X150	M16X150	35,0	12,5	15,0	22	800
DA-UM12SM18ISO	12S	M20X150	M18X150	38,5	14,0	17,0	24	630
DA-UM16SM18ISO	16S	M24X150	M18X150	40,0	14,0	17,5	27	630
DA-UM16SM22ISO	16S	M24X150	M22X150	42,0	15,0	18,5	27	630
DA-UM20SM27ISO	20S	M30X200	M27X200	49,5	18,5	20,5	32	420
DA-UM25SM33ISO	25S	M36X200	M33X200	53,5	18,5	23,0	41	420
DA-UM30SM33ISO	30S	M42X200	M33X200	56,0	18,5	24,0	50	420
DA-UM30SM42ISO	30S	M42X200	M42X200	56,0	19,0	23,5	50	420
DA-UM38SM48ISO	38S	M52X200	M48X200	63,5	21,5	26,0	55	420



COUDE ORIENTABLE MALE METRIQUE ISO

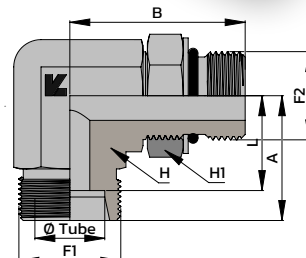
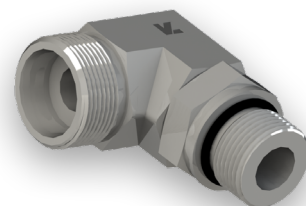

Référence	Ø Tube (mm)	F1	F2	A	B	L	H	H1	PN (bar)
DA-CMM06LM10ISO	6L	M12X150	M10X100	21,0	27,0	14,0	14	14	315
DA-CMM08LM10ISO	8L	M14X150	M10X100	21,0	27,5	14,0	14	14	315
DA-CMM08LM12ISO	8L	M14X150	M12X150	23,0	32,0	16,0	14	17	315
DA-CMM08LM14ISO	8L	M14X150	M14X150	24,0	33,5	17,0	14	19	315
DA-CMM10LM12ISO	10L	M16X150	M12X150	22,0	30,5	15,0	19	17	315
DA-CMM10LM14ISO	10L	M16X150	M14X150	24,0	35,0	17,0	19	19	315
DA-CMM10LM18ISO	10L	M16X150	M18X150	24,0	41,0	17,0	19	24	315
DA-CMM12LM12ISO	12L	M18X150	M12X150	24,0	31,5	17,0	17	17	315
DA-CMM12LM16ISO	12L	M18X150	M16X150	26,0	37,0	19,0	19	22	315
DA-CMM12LM18ISO	12L	M18X150	M18X150	26,0	41,0	19,0	19	24	315
DA-CMM12LM22ISO	12L	M18X150	M12X150	26,0	42,5	19,0	22	27	315
DA-CMM15LM14ISO	15L	M22X150	M14X150	28,0	34,5	21,0	22	19	315
DA-CMM15LM16ISO	15L	M22X150	M16X150	28,0	38,0	21,0	22	22	315
DA-CMM15LM18ISO	15L	M22X150	M18X150	28,0	37,0	21,0	22	24	315
DA-CMM15LM22ISO	15L	M22X150	M22X150	30,0	45,0	23,0	27	27	315
DA-CMM18LM18ISO	18L	M26X150	M18X150	31,0	41,0	23,5	27	24	315
DA-CMM18LM22ISO	18L	M26X150	M22X150	31,5	45,0	24,0	27	27	315
DA-CMM18LM27ISO	18L	M26X150	M27X200	31,0	49,0	23,5	30	32	160
DA-CMM18LM33ISO	18L	M26X150	M33X200	40,0	51,0	30,5	32	41	160
DA-CMM22LM22ISO	22L	M30X200	M22X150	35,0	47,0	27,5	30	27	315
DA-CMM22LM27ISO	22L	M30X200	M27X200	35,0	50,0	28,0	30	32	160
DA-CMM28LM33ISO	28L	M36X200	M33X200	38,0	51,0	30,5	36	41	160
DA-CMM35LM42ISO	35L	M45X200	M42X200	45,0	62,0	38,0	50	50	160
DA-CMM06SM12ISO	6S	M14X150	M12X150	23,0	32,0	16,0	14	17	400
DA-CMM08SM14ISO	8S	M16X150	M14X150	24,0	36,0	17,0	19	19	400
DA-CMM10SM16ISO	10S	M18X150	M16X150	25,0	38,0	18,0	19	22	400
DA-CMM12SM18ISO	12S	M20X150	M18X150	29,0	43,0	22,0	22	24	400
DA-CMM16SM18ISO	16S	M24X150	M18X150	33,0	45,0	24,5	27	24	400
DA-CMM16SM22ISO	16S	M24X150	M22X150	33,0	50,0	24,5	27	27	400
DA-CMM20SM22ISO	20S	M30X200	M22X150	36,0	50,0	25,0	32	27	400
DA-CMM20SM27ISO	20S	M30X200	M27X200	38,0	55,0	27,5	30	32	400
DA-CMM25SM27ISO	25S	M36X200	M27X200	42,0	59,5	30,0	36	32	400
DA-CMM25SM33ISO	25S	M36X200	M33X200	42,0	60,0	30,0	36	41	315



COUDE 45° ORIENTABLE MALE METRIQUE ISO



Référence	Ø Tube (mm)	F1	F2	A	B	L	H	H1	PN (bar)
DA-CM45M08LM12ISO	8L	M14X150	M12X150	19,5	28,0	12,5	14	17	315
DA-CM45M08LM14ISO	8L	M14X150	M14X150	23,0	33,5	16,0	14	19	315
DA-CM45M10LM14ISO	10L	M16X150	M14X150	19,0	33,0	12,0	19	19	315
DA-CM45M12LM14ISO	12L	M18X150	M14X150	25,0	35,0	18,0	19	19	315
DA-CM45M12LM16ISO	12L	M18X150	M16X150	21,0	33,0	14,0	19	22	315
DA-CM45M12LM18ISO	12L	M18X150	M18X150	24,0	38,5	17,0	19	24	315
DA-CM45M12LM22ISO	12L	M18X150	M22X150	24,0	42,0	17,0	27	27	315
DA-CM45M15LM18ISO	15L	M22X150	M18X150	24,0	41,0	17,0	22	24	315
DA-CM45M15LM22ISO	15L	M22X150	M22X150	24,0	42,0	17,0	27	27	315
DA-CM45M18LM22ISO	18L	M26X150	M22X150	24,0	42,0	16,5	27	27	315
DA-CM45M22LM27ISO	22L	M30X200	M27X200	26,0	45,0	18,5	30	32	160
DA-CM45M28LM33ISO	28L	M36X200	M33X200	31,0	49,0	23,0	36	41	160
DA-CM45M20SM22ISO	20S	M30X200	M22X150	37,0	40,0	25,5	27	27	400
DA-CM45M20SM27ISO	20S	M30X200	M27X200	27,0	51,0	16,0	30	32	400
DA-CM45M25SM22ISO	25S	M36X200	M22X150	31,0	46,0	19,0	36	27	400
DA-CM45M25SM33ISO	25S	M36X200	M33X200	31,0	53,0	19,0	36	41	315

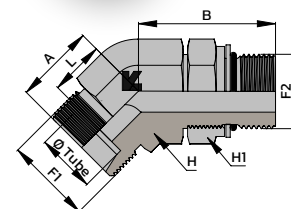
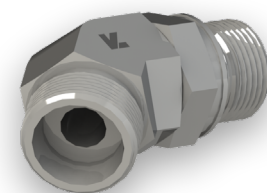

TE ORIENTABLE MALE METRIQUE ISO



Référence	Ø Tube (mm)	F1	F2	A	B	L	H	H1	PN (bar)
DA-TMM08LM14ISO	8L	M14X150	M14X150	21,0	30,5	14,0	14	19	315
DA-TMM10LM12ISO	10L	M16X150	M12X150	22,0	30,5	15,0	19	17	315
DA-TMM10LM14ISO	10L	M16X150	M14X150	22,0	33,5	15,0	19	19	315
DA-TMM12LM16ISO	12L	M18X150	M16X150	24,0	38,0	17,0	19	22	315
DA-TMM12LM18ISO	12L	M18X150	M18X150	26,0	41,0	19,0	19	24	315
DA-TMM15LM22ISO	15L	M22X150	M22X150	28,0	42,5	21,0	22	27	315
DA-TMM18LM22ISO	18L	M26X150	M22X150	31,0	45,0	23,5	27	27	315

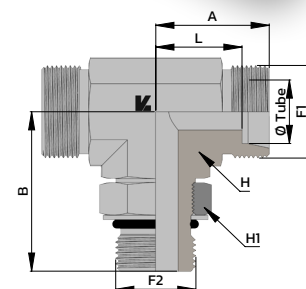
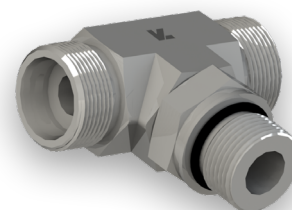

TE ORIENTABLE RENVERSE MALE METRIQUE ISO



Référence	Ø Tube (mm)	F1	F2	A	B	L	L1	H	H1	PN (bar)
DA-TMRM08LM12ISO	8L	M14X150	M12X150	55,0	23,0	16,0	32,0	14	17	315
DA-TMRM10LM12ISO	10L	M16X150	M12X150	53,0	22,0	15,0	30,5	19	17	315
DA-TMRM10LM14ISO	10L	M16X150	M14X150	59,0	24,0	17,0	35,0	19	19	315
DA-TMRM10LM16ISO	10L	M16X150	M16X150	-	-	-	-	-	-	315
DA-TMRM12LM16ISO	12L	M18X150	M16X150	62,0	24,0	17,0	38,0	19	22	315
DA-TMRM12LM22ISO	12L	M18X150	M22X150	71,0	26,0	19,0	45,0	27	27	315
DA-TMRM15LM18ISO	15L	M22X150	M18X150	69,0	28,0	21,0	41,0	22	24	315
DA-TMRM15LM22ISO	15L	M22X150	M22X150	73,0	28,0	21,0	45,0	22	27	315
DA-TMRM18LM22ISO	18L	M26X150	M22X150	77,0	31,5	24,0	45,0	27	27	315

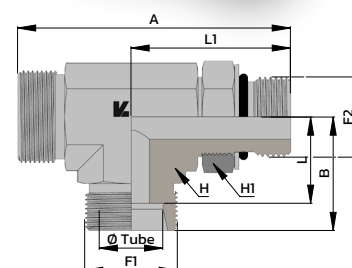
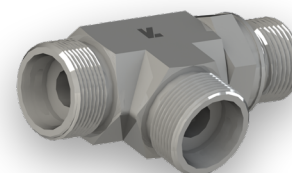

UNION MALE METRIQUE CONIQUE



Référence	Ø Tube (mm)	F1	F2	A	B	L	H	PN (bar)
DA-UMC06LM10	6L	M12X150	M10X100 CO	24,0	10,0	7,0	12	315
DA-UMC08LM8X100	8L	M14X150	M8X100 CO	23,5	8,0	8,5	17	315
DA-UMC10LM14	10L	M16X150	M14X150 CO	28,0	12,0	9,0	17	315
DA-UMC12LM16	12L	M18X150	M16X150 CO	29,0	12,0	10,0	19	315

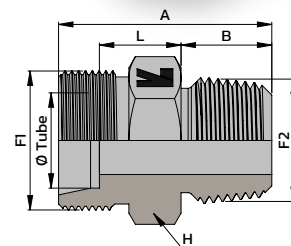
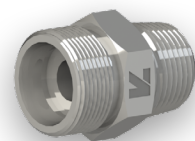

UNION MALE METRIQUE CONIQUE COMPLETE / SERIE LL

Référence	Ø Tube (mm)	F1	F2	A	B	L	H	PN (bar)
DA-UMC06LLM06C-ZN	6LL	M10X100	M06X100 CO	21,0	8,0	6,5	12	100
DA-UMC06LLM08C-ZN	6LL	M10X100	M08X100 CO	20,0	8,0	6,5	11	100
DA-UMC06LLMC-ZN	6LL	M10X100	M08X125 CO	22,0	9,0	7,5	11	100
DA-UMC06LLM10C-ZN	6LL	M10X100	M10X100 CO	21,0	9,0	6,5	11	100
DA-UMC08LLM10C-ZN	8LL	M12X100	M10X100 CO	24,0	8,0	8,5	11	100

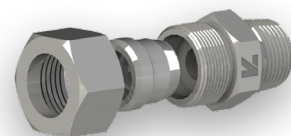

COUDE MALE METRIQUE CONIQUE



Référence	Ø Tube (mm)	F1	F2	A	B	L	H	PN (bar)
DA-CMC06LM10	6L	M12X150	M10X100 CO	20,0	20,0	12,0	12	315
DA-CMC08LM12	8L	M14X150	M12X150 CO	26,0	26,0	14,0	14	315
DA-CMC10LM14	10L	M16X150	M14X150 CO	27,0	27,0	15,0	17	315
DA-CMC12LM16	12L	M18X150	M16X150 CO	28,0	28,0	17,0	19	315
DA-CMC15LM18	15L	M22X150	M18X150 CO	32,0	34,0	21,0	19	315
DA-CMC18LM22	18L	M26X150	M22X150 CO	-	-	-	-	315

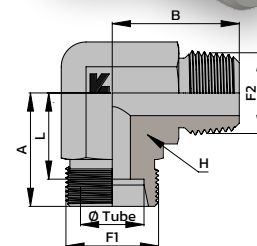
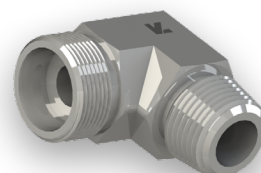

COUDE MALE METRIQUE CONIQUE COMPLET / SERIE LL

Référence	Ø Tube (mm)	F1	F2	A	B	L	H	PN (bar)
DA-CMC06LLM06C-ZN	6LL	M10X100	M6X100 CO	15,0	15,0	9,5	11	100
DA-CMC06LLM08C-ZN	6LL	M10X100	M8X100 CO	16,5	15,0	9,5	11	100
DA-CMC06LLMC-ZN	6LL	M10X100	M8X125 CO	17,5	15,0	9,5	11	100
DA-CMC06LLM10C-ZN	6LL	M10X100	M10X100 CO	16,5	15,0	9,5	11	100
DA-CMC08LLM10C-ZN	8LL	M12X100	M10X100 CO	17,0	17,0	11,5	12	100

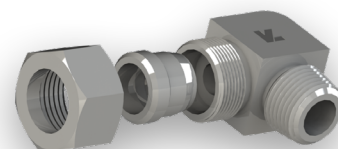

UNION MALE SAE



Référence	Ø Tube (mm)	F1	F2	A	B	L	H	PN (bar)
DA-UM06L7/16U	6L	M12X150	7/16" UNF	26,0	9,0	10,0	14	315
DA-UM08L7/16U	8L	M14X150	7/16" UNF	26,0	9,0	10,0	17	315
DA-UM08L1/2U	8L	M14X150	1/2" UNF	26,0	9,0	10,0	16	315
DA-UM08L9/16U	8L	M14X150	9/16" UNF	29,0	10,0	12,0	19	315
DA-UM10L7/16U	10L	M16X150	7/16" UNF	27,0	9,0	11,0	17	315
DA-UM10L1/2U	10L	M16X150	1/2" UNF	27,0	11,0	11,0	17	315
DA-UM10L9/16U	10L	M16X150	9/16" UNF	30,0	13,0	10,0	17	315
DA-UM10L3/4U	10L	M16X150	3/4" UNF	31,0	11,0	13,0	24	315
DA-UM12L9/16U	12L	M18X150	9/16" UNF	28,0	10,0	11,0	19	315
DA-UM12L3/4U	12L	M18X150	3/4" UNF	31,0	11,0	13,0	24	315
DA-UM12L7/8U	12L	M18X150	7/8" UNF	34,0	12,7	14,0	27	315
DA-UM12L1.1/16U	12L	M18X150	1"1/16 UN	36,0	15,0	14,0	32	315
DA-UM15L9/16U	15L	M22X150	9/16" UNF	31,0	10,0	14,0	24	315
DA-UM15L3/4U	15L	M22X150	3/4" UNF	32,0	11,0	14,0	24	315
DA-UM15L7/8U	15L	M22X150	7/8" UNF	35,0	12,7	15,3	27	315
DA-UM18L3/4U	18L	M26X150	3/4" UNF	33,0	11,0	15,0	27	315
DA-UM18L7/8U	18L	M26X150	7/8" UNF	35,0	12,7	14,8	27	315
DA-UM18L1.1/16U	18L	M26X150	1"1/16 UN	38,0	15,0	15,5	32	315
DA-UM22L7/8U	22L	M30X200	7/8" UNF	37,0	12,7	16,8	32	160
DA-UM22L1.1/16U	22L	M30X200	1"1/16 UN	39,0	15,0	16,5	32	160
DA-UM22L1.5/16U	22L	M30X200	1"5/16 UN	39,0	15,0	16,5	41	160
DA-UM28L1.1/16U	28L	M36X200	1"1/16 UN	40,0	15,0	17,5	41	160
DA-UM28L1.5/16U	28L	M36X200	1"5/16 UN	40,0	15,0	17,5	41	160
DA-UM35L1.5/16U	35L	M45X200	1"5/16 UN	43,0	15,0	17,5	46	160
DA-UM35L1.5/8U	35L	M45X200	1"5/8 UN	43,0	15,0	17,5	50	160
DA-UM35L1.7/8U	35L	M45X200	1"7/8 UN	45,0	15,0	19,4	55	160
DA-UM42L1.5/8U	42L	M52X200	1"5/8 UN	45,0	15,0	19,0	55	160
DA-UM42L1.7/8U	42L	M52X200	1"7/8 UN	-	-	-	-	160
DA-UM06S7/16U	6S	M14X150	7/16" UNF	31,0	11,0	13,0	14	630
DA-UM08S7/16U	8S	M16X150	7/16" UNF	31,0	9,0	16,0	19	630
DA-UM08S9/16U	8S	M16X150	9/16" UNF	32,0	12,0	13,0	17	630
DA-UM10S9/16U	10S	M18X150	9/16" UNF	32,0	10,0	16,5	22	630
DA-UM12S9/16U	12S	M20X150	9/16" UNF	32,0	10,0	17,5	24	630
DA-UM12S3/4U	12S	M20X150	3/4" UNF	36,0	11,0	17,5	24	630
DA-UM16S3/4U	16S	M24X150	3/4" UNF	35,0	11,0	16,5	27	400
DA-UM16S7/8U	16S	M24X150	7/8" UNF	40,0	12,7	18,5	32	400
DA-UM16S1.1/16U	16S	M24X150	1"1/16 UN	45,0	14,0	18,0	32	400
DA-UM20S3/4U	20S	M30X200	3/4" UNF	42,0	11,0	20,5	32	400
DA-UM20S7/8U	20S	M30X200	7/8" UNF	44,0	12,7	20,5	32	400
DA-UM20S1.1/16U	20S	M30X200	1"1/16 UN	46,0	15,0	20,5	32	400
DA-UM25S1.1/16U	25S	M36X200	1"1/16 UN	50,0	15,0	23,0	36	400
DA-UM25S1.5/16U	25S	M36X200	1"5/16 UN	50,0	18,5	19,5	41	400
DA-UM30S1.5/16U	30S	M42X200	1"5/16 UN	52,0	15,0	23,5	46	400
DA-UM30S1.5/8U	30S	M42X200	1"5/8 UN	52,0	15,0	23,5	50	400
DA-UM38S1.5/8U	38S	M52X200	1"5/8 UN	57,0	15,0	24,0	55	315

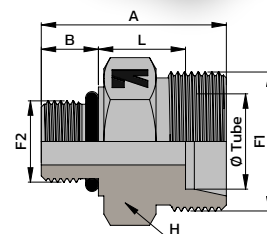
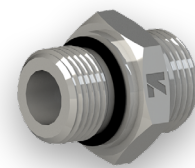

COUDE MALE ORIENTABLE SAE



Référence	Ø Tube (mm)	F1	F2	A	B	L	H	H1	PN (bar)
DA-CMU08L7/16	8L	M14X150	7/16" UNF	21,0	29,0	14,0	14	14	315
DA-CMU10L7/16	10L	M16X150	7/16" UNF	24,0	35,0	15,5	19	14	315
DA-CMU10L3/4	10L	M16X150	3/4" UNF	24,0	38,0	16,5	19	22	315
DA-CMU12L7/16	12L	M18X150	7/16" UNF	23,5	28,0	16,0	17	14	315
DA-CMU12L9/16	12L	M18X150	9/16" UNF	26,0	36,0	19,0	19	17	315
DA-CMU12L3/4	12L	M18X150	3/4" UNF	24,0	38,0	19,0	19	22	315
DA-CMU15L3/4	15L	M22X150	3/4" UNF	28,0	41,0	21,0	22	22	315
DA-CMU15L7/8	15L	M22X150	7/8" UNF	28,0	43,0	21,0	22	27	315
DA-CMU15L1.1/16	15L	M22X150	1"1/16 UN	-	-	-	22,0	32	315
DA-CMU15L1.5/16	15L	M22X150	1"5/16 UN	-	-	-	22,0	41	160
DA-CMU18L7/8	18L	M26X150	7/8" UNF	31,0	47,0	24,0	27	27	315
DA-CMU22L1.1/16	22L	M30X200	1"1/16 UN	35,0	52,0	28,0	32	32	160
DA-CMU28L1.5/16	28L	M36X200	1"5/16 UN	38,0	59,0	23,5	36	41	160
DA-CMU35L1.5/16	35L	M45X200	1"5/16 UN	-	-	-	-	41	160
DA-CMU08S9/16	8S	M16X150	9/16" UNF	24,0	37,0	17,0	17	19	400
DA-CMU20S1.1/16	20S	M30X200	1"1/16 UN	37,0	56,0	26,5	27	32	400
DA-CMU25S1.1/16	25S	M36X200	1"1/16 UN	-	-	-	36	32	400
DA-CMU25S1.5/16	25S	M36X200	1"5/16 UN	42,0	64,0	30,0	36	41	400

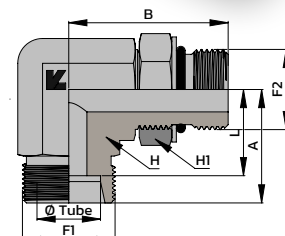
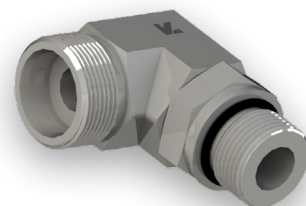

TE MALE ORIENTABLE SAE



Référence	Ø Tube (mm)	F1	F2	A	B	L	H	H1	PN (bar)
DA-TMU22L1.1/16U	22L	M30X200	1"1/16 UN	37,5	52,1	30,0	33	38	160

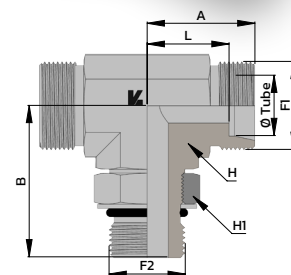
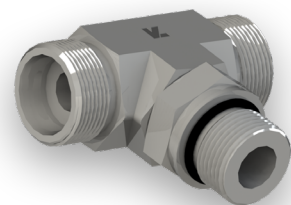

TE MALE ORIENTABLE RENVERSE SAE



Référence	Ø Tube (mm)	F1	F2	A	B	L	L1	H	H1	PN (bar)
DA-TMRU10L7/16U	10L	M16X150	7/16" UNF							
DA-TMRU15L3/4U	15L	M22X150	3/4" UNF	69,0	28,0	21,0	41,0	22	22	315
DA-TMRU28L1.5/16U	28L	M36X200	1"5/16 UN	97,0	38,0	31,0	59,0	36	41	160

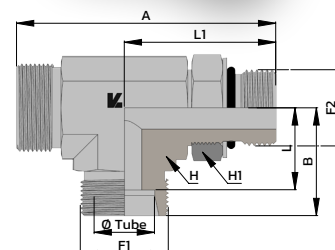
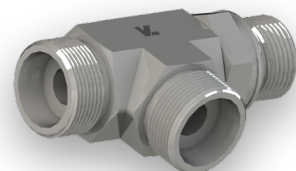

UNION MALE NPT



Référence	Ø Tube (mm)	F1	F2	A	B	L	H	PN (bar)
DA-UM06L1/8NPT	6L	M12X150	1/8"	24,0	10,0	7,0	12	315
DA-UM06L1/4NPT	6L	M12X150	1/4"	30,0	15,0	8,0	14	315
DA-UM08L1/4NPT	8L	M14X150	1/4"	30,0	15,0	8,0	17	315
DA-UM10L1/4NPT	10L	M16X150	1/4"	31,0	15,0	9,0	17	315
DA-UM10L3/8NPT	10L	M16X150	3/8"	32,0	15,0	10,0	19	315
DA-UM10L1/2NPT	10L	M16X150	1/2"	-	-	-	-	-
DA-UM12L1/4NPT	12L	M18X150	1/4"	32,0	15,0	10,0	19	315
DA-UM12L3/8NPT	12L	M18X150	3/8"	32,0	15,0	10,0	19	315
DA-UM12L1/2NPT	12L	M18X150	1/2"	37,0	19,5	10,5	22	315
DA-UM12L3/4NPT	12L	M18X150	3/4"	-	-	-	-	-
DA-UM15L3/8NPT	15L	M22X150	3/8"	-	-	-	-	-
DA-UM15L1/2NPT	15L	M22X150	1/2"	38,0	19,5	11,5	24	315
DA-UM18L1/2NPT	18L	M26X150	1/2"	39,0	19,5	12,0	27	315
DA-UM18L3/4NPT	18L	M26X150	3/4"	-	-	-	-	-
DA-UM22L3/4NPT	22L	M30X200	3/4"	41,0	20,0	13,5	32	160
DA-UM28L1NPT	28L	M36X200	1"	47,0	25,0	14,5	41	160
DA-UM35L1.1/4NPT	35L	M45X200	1"1/4	51,0	25,5	15,0	46	160
DA-UM42L1.1/2NPT	42L	M52X200	1"1/2	53,0	26,0	16,0	55	160
DA-UM06S1/4NPT	6S	M14X150	1/4"	33,0	15,0	11,0	17	630
DA-UM08S1/4NPT	8S	M16X150	1/4"	35,0	15,0	13,0	17	630
DA-UM10S1/4NPT	10S	M18X150	1/4"	35,0	15,0	13,0	19	630
DA-UM10S3/8NPT	10S	M18X150	3/8"	35,0	15,0	12,5	19	630
DA-UM12S1/4NPT	12S	M20X150	1/4"	37,0	15,0	14,5	22	630
DA-UM12S3/8NPT	12S	M20X150	3/8"	37,0	15,0	14,5	22	630
DA-UM12S1/2NPT	12S	M20X150	1/2"	42,0	19,5	15,0	22	630
DA-UM14S1/2NPT	14S	M22X150	1/2"	44,0	19,5	16,5	24	630
DA-UM16S1/2NPT	16S	M24X150	1/2"	44,0	19,5	16,0	27	400
DA-UM20S3/4NPT	20S	M30X200	3/4"	48,0	20,0	17,5	32	400
DA-UM25S1NPT	25S	M36X200	1"	57,0	25,0	20,0	41	400
DA-UM30S1.1/4NPT	30S	M42X200	1"1/4	60,0	25,5	21,0	46	400

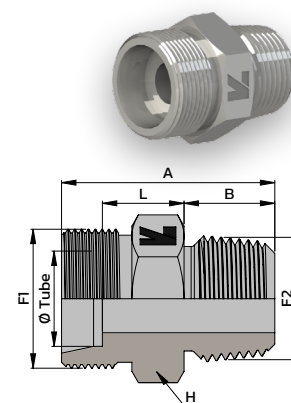

UNION MALE NPT COMPLETE / SERIE LL

Référence	Ø Tube (mm)	F1	F2	A	B	L	H	PN (bar)
DA-UM06LLNPTC-ZN	6LL	M10X100	1/8"	22,0	9,0	6,5	11	100

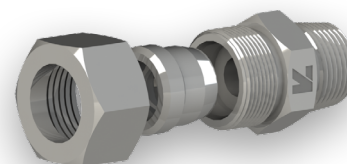



COUDE MALE NPT

Référence	Ø Tube (mm)	F1	F2	A	B	L	H	PN (bar)
DA-CM06L1/8NPT	6L	M12X150	1/8"	19,0	20,0	12,0	12	315
DA-CM08L1/8NPT	8L	M14X150	1/8"	21,0	24,0	14,0	12	315
DA-CM08L1/4NPT	8L	M14X150	1/4"	21,0	26,0	14,0	14	315
DA-CM08L3/8NPT	8L	M14X150	3/8"	23,0	28,0	16,0	17	315
DA-CM10L1/4NPT	10L	M16X150	1/4"	22,0	27,0	15,0	17	315
DA-CM10L3/8NPT	10L	M16X150	3/8"	24,0	28,0	17,0	17	315
DA-CM12L1/4NPT	12L	M18X150	1/4"	24,0	28,0	17,0	19	315
DA-CM12L3/8NPT	12L	M18X150	3/8"	24,0	28,0	17,0	19	315
DA-CM12L1/2NPT	12L	M18X150	1/2"	27,0	34,0	20,0	19	315
DA-CM15L1/2NPT	15L	M22X150	1/2"	28,0	34,0	21,0	19	315
DA-CM18L1/2NPT	18L	M26X150	1/2"	31,0	36,0	23,5	24	315
DA-CM22L3/4NPT	22L	M30X200	3/4"	35,0	42,0	27,5	27	160
DA-CM28L1NPT	28L	M36X200	1"	38,0	48,0	30,5	36	160
DA-CM35L1.1/4NPT	35L	M45X200	1"1/4	45,0	57,0	34,5	41	160
DA-CM42L1.1/2NPT	42L	M52X200	1"1/2	51,0	61,0	40,0	50	160
DA-CM06S1/4NPT	6S	M14X150	1/4"	23,0	26,0	16,0	14	630
DA-CM08S1/4NPT	8S	M16X150	1/4"	24,0	27,0	17,0	17	630
DA-CM10S3/8NPT	10S	M18X150	3/8"	25,0	28,0	17,5	19	630
DA-CM12S3/8NPT	12S	M20X150	3/8"	29,0	28,0	21,5	22	630
DA-CM14S1/2NPT	14S	M22X150	1/2"	30,0	34,0	22,0	19	630
DA-CM16S1/2NPT	16S	M24X150	1/2"	33,0	36,0	24,5	24	400
DA-CM20S3/4NPT	20S	M30X200	3/4"	37,0	42,0	26,5	27	400
DA-CM25S1NPT	25S	M36X200	1"	42,0	48,0	30,0	36	400
DA-CM30S1.1/4NPT	30S	M42X200	1"1/4	49,0	57,0	35,5	41	400
DA-CM38S1.1/2NPT	38S	M52X200	1"1/2	57,0	61,0	41,0	50	315

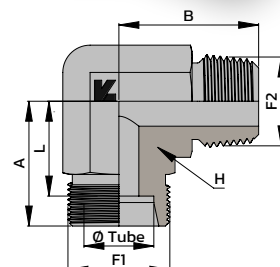
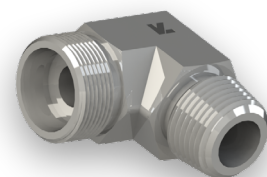

COUDE MALE NPT COMPLET / SERIE LL

Référence	Ø Tube (mm)	F1	F2	A	B	L	H	PN (bar)
DA-CM04LL1/8NPTCZN	4LL	M8X100	1/8"	15,0	17,0	11,0	11	100
DA-CM06LL1/8NPTCZN	6LL	M10X100	1/8"	15,0	17,0	9,5	11	100
DA-CM08LL1/8NPTCZN	8LL	M12X100	1/8"	17,0	20,0	11,5	12	100

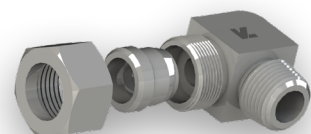

ADAPTATEUR TOURNANT DKO / NPT

Référence	Ø Tube (mm)	F1	F2	A	B	H1	H2	PN (bar)
DA-AD15LDKO1/2NPT	15L	M22X150	1/2"	49,0	19,0	22	27	315
DA-AD12SDKO3/8NPT	12S	M20X150	3/8"	-	-	-	-	630

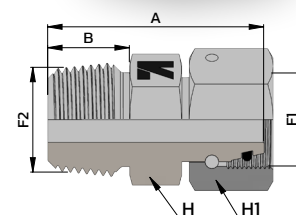
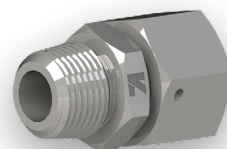

BOUCHON FEMELLE DIN 24°

Référence	Ø Tube (mm)	A	PN (bar)	Référence complète
DA-BF06L	6L	18,6	500	DA-BF06L-C
DA-BF08L	8L	18,5	500	DA-BF08L-C
DA-BF10L	10L	20,1	500	DA-BF10L-C
DA-BF12L	12L	20,6	400	DA-BF12L-C
DA-BF15L	15L	20,5	400	DA-BF15L-C
DA-BF18L	18L	22,6	400	DA-BF18L-C
DA-BF22L	22L	25,1	250	DA-BF22L-C
DA-BF28L	28L	25,5	250	DA-BF28L-C
DA-BF35L	35L	30	250	DA-BF35L-C
DA-BF42L	42L	30	250	DA-BF42L-C
-	6S	18,6	800	DA-BF06S-C
-	8S	18,5	800	DA-BF08S-C
-	10S	20,1	800	DA-BF10S-C
-	12S	20,6	630	DA-BF12S-C
DA-BF14S	14S	22,5	630	DA-BF14S-C
DA-BF16S	16S	23,5	630	DA-BF16S-C
DA-BF20S	20S	28,5	420	DA-BF20S-C
DA-BF25S	25S	29	420	DA-BF25S-C
DA-BF30S	30S	30,5	420	DA-BF30S-C
DA-BF38S	38S	33	420	DA-BF38S-C

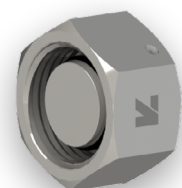
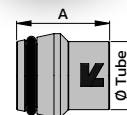
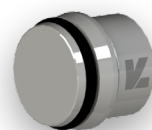

Bouchon femelle DIN 24° complet

BOUCHON MALE DIN 24°

Référence	Ø Tube (mm)	F	A	L	H	PN (bar)
DA-BM06L	6L	M12X150	14,0	7,0	12	315
DA-BM08L	8L	M14X150	15,0	8,0	14	315
DA-BM10L	10L	M16X150	16,0	9,0	17	315
DA-BM12L	12L	M18X150	17,0	10,0	19	315
DA-BM15L	15L	M22X150	18,0	11,0	24	315
DA-BM18L	18L	M26X150	19,0	11,5	27	315
DA-BM22L	22L	M30X200	21,0	13,5	32	160
DA-BM28L	28L	M36X200	22,0	14,5	41	160
DA-BM35L	35L	M45X200	25,0	14,5	46	160
DA-BM42L	42L	M52X200	30,0	19,0	55	160
DA-BM06S	6S	M14X150	18,0	11,0	14	630
DA-BM08S	8S	M16X150	20,0	13,0	17	630
DA-BM10S	10S	M18X150	20,0	12,5	19	630
DA-BM12S	12S	M20X150	22,0	14,5	22	630
DA-BM14S	14S	M22X150	24,0	16,0	24	630
DA-BM16S	16S	M24X150	24,0	15,5	27	400
DA-BM20S	20S	M30X200	28,0	17,5	32	400
DA-BM25S	25S	M36X200	32,0	20,0	41	400
DA-BM30S	30S	M42X200	34,0	20,5	46	400
DA-BM38S	38S	M52X200	39,0	23,0	55	315

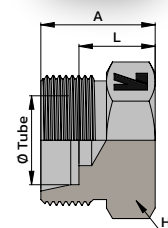
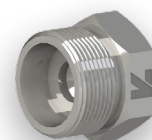

BOUCHON MALE BSPP JE

Référence	F	A	L	D	H	PN (bar)
DA-BM1/8JE	1/8"	12,3	8,0	14,0	5	400
DA-BM1/4JE	1/4"	17,3	12,0	19,0	6	400
DA-BM3/8JE	3/8"	17,3	12,0	22,0	8	400
DA-BM1/2JE	1/2"	19,3	14,0	27,0	10	400
DA-BM3/4JE	3/4"	21,3	16,0	32,0	12	400
DA-BM1JE	1"	22,8	16,0	39,9	17	400
DA-BM1.1/4JE	1"1/4	22,8	16,0	49,9	22	315
DA-BM1.1/2JE	1"1/2	22,8	16,0	55,0	24	315

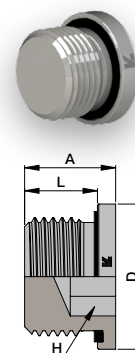

BOUCHON MALE METRIQUE JE

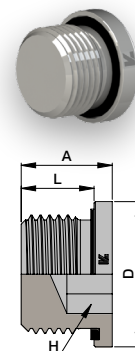
Référence	F	A	L	D	H	PN (bar)
DA-BM08JE	M8X100	12,3	8,0	12,0	4	400
DA-BM10JE	M10X100	12,3	8,0	14,0	5	400
DA-BM12JE	M12X150	17,3	12,0	17,0	6	400
DA-BM12X100JE	M12X100	15,0	10,0	17,0	6	400
DA-BM14JE	M14X150	17,3	12,0	19,0	6	400
DA-BM16JE	M16X150	17,3	12,0	22,0	8	400
DA-BM18JE	M18X150	17,3	12,0	24,0	8	400
DA-BM20JE	M20X150	19,3	14,0	26,0	10	400
DA-BM22JE	M22X150	19,3	14,0	27,0	10	400
DA-BM26JE	M26X150	21,3	16,0	32,0	12	400
DA-BM27JE	M27X200	21,3	16,0	32,0	12	400
DA-BM33JE	M33X200	22,8	16,0	40,0	17	400
DA-BM42JE	M42X200	22,8	16,0	50,0	22	315
DA-BM48JE	M48X200	22,8	16,0	55,0	24	315

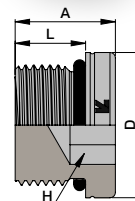
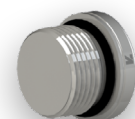

BOUCHON MALE METRIQUE ISO

Référence	F	A	D	L	H	PN (bar)
DA-BM08ISO	M8X100	13,0	12,0	9,5	4	630
DA-BM10ISO	M10X100	13,5	13,8	9,5	5	630
DA-BM12ISO	M12X150	16,0	16,8	11,0	6	630
DA-BM14ISO	M14X150	16,0	18,8	11,0	6	630
DA-BM16ISO	M16X150	17,5	21,0	12,5	8	630
DA-BM18ISO	M18X150	19,0	23,8	14,0	8	630
DA-BM20ISO	M20X150	19,0	26,8	14,0	10	630
DA-BM22ISO	M22X150	20,0	27,0	15,0	10	630
DA-BM26ISO	M26X150	21,0	30,8	16,0	12	400
DA-BM27ISO	M27X200	23,5	32,0	18,5	12	400
DA-BM33ISO	M33X200	24,5	40,8	18,5	14	400
DA-BM42ISO	M42X200	25,5	49,8	19,0	22	400
DA-BM48ISO	M48X200	28,0	54,8	21,5	24	400



Embout

Protections

DIN

JIC

ORFS

BOUCHON MALE SAE

Référence	F	A	D	L	H	PN (bar)
DA-BM7/16UNF	7/16" UNF	12,0	14,0	9,1	4,78	420
DA-BM1/2UNF	1/2" UNF	12,0	16,0	9,1	4,78	420
DA-BM9/16UNF	9/16" UNF	12,7	17,5	9,9	6,35	420
DA-BM3/4UNF	3/4" UNF	14,8	22,0	11,1	7,95	420
DA-BM7/8UNF	7/8" UNF	16,5	25,4	12,7	9,52	420
DA-BM1.1/16UNF	1"1/16 UN	19,7	31,8	15,1	14,3	380
DA-BM1.5/16UNF	1"5/16 UN	19,5	38,0	15,1	15,88	380
DA-BM1.5/8UNF	1"5/8 UN	19,5	48,0	15,1	19,05	280
DA-BM1.7/8UNF	1"7/8 UN	19,5	54,0	15,1	19,05	210

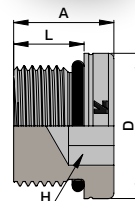
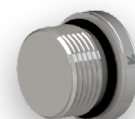

BSP

GAZ

Gratissage

Coupleurs

UNION MALE VALVE AGRICOLE

Référence	F1	F2	A	B	C	H	PN (bar)
GMVA18X150EM10	M18X150	10L - M16X150	33,5	15,8	11,0	19	210
GMVA18X150EM12	M18X150	12L - M18X150	34,0	15,8	11,0	19	210
GMVA18X150EM15	M18X150	15L - M22X150	35,0	15,8	11,0	22	210

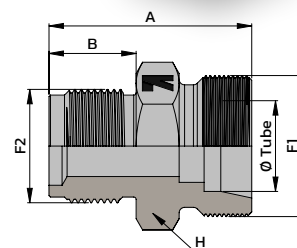
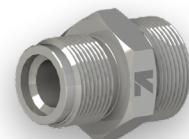

Vannes Composants

Brides

Prises-Pression Manomètres

Colliers

Joint

Existe également en version série GAZ FRANCAIS a retrouver sur notre catalogue RACCORD GAZ

EMBOUT A SOUDER
**BLACK
 OXYDE**

Référence	Ø Tube (mm)	A	D	PN (bar)
DA-ES06	6L / 6S	31,0	2,5	630
DA-ES08	8L / 8S	31,0	4,0	630
DA-ES10	10L / 10S	32,5	6,0	400
DA-ES12	12L / 12S	32,5	7,0	630
DA-ES14	14S	38,5	8,0	400
DA-ES15	15L	34,0	10,0	315
DA-ES16	16S	39,0	10,0	400
DA-ES18	18L	35,5	13,0	315
DA-ES20	20S	45,0	12,0	400
DA-ES22	22L	38,5	17,0	160
DA-ES25	25S	49,5	17,0	315
DA-ES28	28L	41,5	23,0	160
DA-ES30	30S	52,0	20,0	315
DA-ES35	35L	47,5	29,0	160
DA-ES38	38S	56,5	26,0	315
DA-ES42	42L	47,5	36,0	160

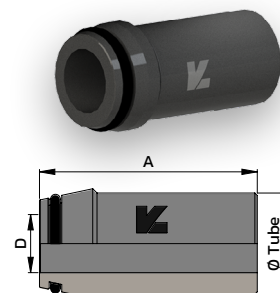
UNION SIMPLE A SOUDER
**BLACK
 OXYDE**

Référence	Ø Tube (mm)	F	A	D	L	H	PN (bar)
DA-USS06L	6L	M12X150	21,0	10,0	14,0	12	315
DA-USS08L	8L	M14X150	23,0	12,0	16,0	14	315
DA-USS10L	10L	M16X150	25,0	14,0	18,0	17	315
DA-USS12L	12L	M18X150	25,0	16,0	18,0	19	315
DA-USS15L	15L	M22X150	29,0	19,0	22,0	22	315
DA-USS18L	18L	M26X150	31,0	22,0	23,5	27	315
DA-USS22L	22L	M30X200	36,0	27,0	28,5	32	160
DA-USS28L	28L	M36X200	38,0	32,0	30,5	41	160
DA-USS35L	35L	M45X200	43,0	40,0	32,5	46	160
DA-USS42L	42L	M52X200	46,0	46,0	35,0	55	160
DA-USS06S	6S	M14X150	26,0	11,0	19,0	14	630
DA-USS08S	8S	M16X150	28,0	13,0	21,0	17	630
DA-USS10S	10S	M18X150	30,0	15,0	22,5	19	630
DA-USS12S	12S	M20X150	32,0	17,0	24,5	22	630
DA-USS14S	14S	M22X150	35,0	19,0	27,0	24	630
DA-USS16S	16S	M24X150	35,0	21,0	26,5	27	400
DA-USS20S	20S	M30X200	40,0	26,0	29,5	32	400
DA-USS25S	25S	M36X200	44,0	31,0	32,0	41	400
DA-USS30S	30S	M42X200	49,0	36,0	35,5	46	400
DA-USS38S	38S	M52X200	54,0	44,0	38,0	55	315

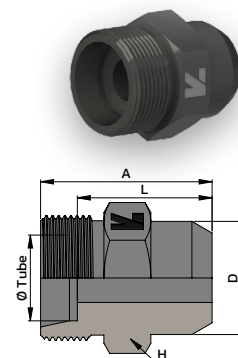

UNION DOUBLE A SOUDER

BLACK
OXYDE

Référence	Ø Tube (mm)	F	A	D	L	PN (bar)
DA-UDS06L	6L	M12X150	70	18	56	315
DA-UDS08L	8L	M14X150	70	20	56	315
DA-UDS10L	10L	M16X150	72	22	58	315
DA-UDS12L	12L	M18X150	72	25	58	315
DA-UDS15L	15L	M22X150	84	28	70	315
DA-UDS18L	18L	M26X150	84	32	69	315
DA-UDS22L	22L	M30X200	88	36	73	160
DA-UDS28L	28L	M36X200	88	40	73	160
DA-UDS35L	35L	M45X200	92	50	71	160
DA-UDS42L	42L	M52X200	92	60	70	160

DA-UDS06S	6S	M14X150	74	20	60	630
DA-UDS08S	8S	M16X150	74	22	60	630
DA-UDS10S	10S	M18X150	74	25	59	630
DA-UDS12S	12S	M20X150	74	28	59	630
DA-UDS14S	14S	M22X150	88	30	72	630
DA-UDS16S	16S	M24X150	88	35	71	400
DA-UDS20S	20S	M30X200	92	38	71	400
DA-UDS25S	25S	M36X200	96	45	72	400
DA-UDS30S	30S	M42X200	100	50	73	400
DA-UDS38S	38S	M52X200	104	60	72	315

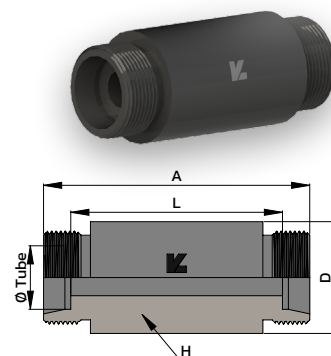

COUDE MALE A SOUDER

BLACK
OXYDE

Référence	Ø Tube (mm)	F	A	B	D	L	H	PN (bar)
DA-CMS06L	6L	M12X150	19,0	19,0	10,0	12,0	12	315
DA-CMS08L	8L	M14X150	21,0	21,0	12,0	14,0	12	315
DA-CMS10L	10L	M16X150	22,0	24,0	14,0	15,0	14	315
DA-CMS12L	12L	M18X150	24,0	25,0	16,0	17,0	17	315
DA-CMS15L	15L	M22X150	28,0	28,0	19,0	21,0	19	315
DA-CMS18L	18L	M26X150	31,0	31,0	22,0	23,5	24	315
DA-CMS22L	22L	M30X200	35,0	35,0	27,0	27,5	27	160
DA-CMS28L	28L	M36X200	38,0	38,0	32,0	30,5	36	160
DA-CMS35L	35L	M45X200	45,0	45,0	40,0	34,5	41	160
DA-CMS42L	42L	M52X200	51,0	51,0	46,0	40,0	50	160

DA-CMS06S	6S	M14X150	23,0	23,0	11,0	16,0	12	630
DA-CMS08S	8S	M16X150	24,0	24,0	13,0	17,0	14	630
DA-CMS10S	10S	M18X150	25,0	25,0	15,0	17,5	17	630
DA-CMS12S	12S	M20X150	29,0	29,0	17,0	21,5	17	630
DA-CMS14S	14S	M22X150	30,0	30,0	19,0	22,0	19	630
DA-CMS16S	16S	M24X150	33,0	33,0	21,0	24,5	24	400
DA-CMS20S	20S	M30X200	37,0	37,0	26,0	26,5	27	400
DA-CMS25S	25S	M36X200	42,0	42,0	31,0	30,0	36	400
DA-CMS30S	30S	M42X200	49,0	49,0	36,0	35,5	41	400
DA-CMS38S	38S	M52X200	57,0	57,0	44,0	41,0	50	315

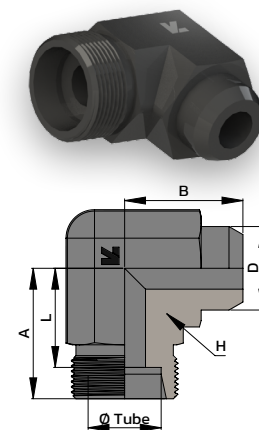

REDUCTION MALE / FEMELLE JE

Référence	Modèle	F1	F2	A	B	H	PN (bar)
DA-RMF1/8X1/4JE	LONG	1/8"	1/4"	31,0	8,0	19	400
DA-RMF1/8X3/8JE	LONG	1/8"	3/8"	32,0	8,0	24	400
DA-RMF1/4X1/8JE	LONG	1/4"	1/8"	29,0	12,0	19	400
DA-RMF1/4X3/8JE	LONG	1/4"	3/8"	36,0	12,0	24	400
DA-RMF1/4X1/2JE	LONG	1/4"	1/2"	40,0	12,0	30	400
DA-RMF1/4X3/4JE	LONG	1/4"	3/4"	43,0	12,0	36	400
DA-RMF3/8X1/8JE	COURT	3/8"	1/8"	23,0	12,0	22	400
DA-RMF3/8X1/4JE	LONG	3/8"	1/4"	36,0	12,0	22	400
DA-RMF3/8X1/2JE	LONG	3/8"	1/2"	41,0	12,0	30	400
DA-RMF3/8X3/4JE	LONG	3/8"	3/4"	44,0	12,0	36	315
DA-RMF1/2X1/8JE	COURT	1/2"	1/8"	24,0	14,0	27	400
DA-RMF1/2X1/4JE	COURT	1/2"	1/4"	24,0	14,0	27	400
DA-RMF1/2X3/8JE	LONG	1/2"	3/8"	37,0	14,0	27	400
DA-RMF1/2X3/4JE	LONG	1/2"	3/4"	46,0	14,0	36	315
DA-RMF1/2X1JE	LONG	1/2"	1"	49,0	14,0	41	315
DA-RMF1/2X1.1/4JE	LONG	1/2"	1"1/4	53,0	14,0	55	315
DA-RMF3/4X1/4JE	COURT	3/4"	1/4"	26,0	16,0	32	315
DA-RMF3/4X3/8JE	COURT	3/4"	3/8"	26,0	16,0	32	315
DA-RMF3/4X1/2JE	LONG	3/4"	1/2"	41,0	16,0	32	315
DA-RMF3/4X1JE	LONG	3/4"	1"	51,0	16,0	41	315
DA-RMF3/4X1.1/4JE	LONG	3/4"	1"1/4	55,0	16,0	55	315
DA-RMF3/4X1.1/2JE	LONG	3/4"	1"1/2	57,0	16,0	60	250
DA-RMF1X1/4JE	COURT	1"	1/4"	29,0	18,0	41	315
DA-RMF1X3/8JE	COURT	1"	3/8"	29,0	18,0	41	315
DA-RMF1X1/2JE	COURT	1"	1/2"	29,0	18,0	41	315
DA-RMF1X3/4JE	LONG	1"	3/4"	47,0	18,0	41	315
DA-RMF1X1.1/4JE	LONG	1"	1"1/4	57,0	18,0	55	315
DA-RMF1X1.1/2JE	LONG	1"	1"1/2	59,0	18,0	60	250
DA-RMF1.1/4X1/2JE	COURT	1"1/4	1/2"	32,0	20,0	50	315
DA-RMF1.1/4X3/4JE	COURT	1"1/4	3/4"	32,0	20,0	50	315
DA-RMF1.1/4X1JE	LONG	1"1/4	1"	52,0	20,0	50	315
DA-RMF1.1/4X1.1/2J	LONG	1"1/4	1"1/2	60,0	20,0	60	250
DA-RMF1.1/2X1/2JE	COURT	1"1/2	1/2"	36,0	22,0	55	250
DA-RMF1.1/2X3/4JE	COURT	1"1/2	3/4"	36,0	22,0	55	250
DA-RMF1.1/2X1JE	COURT	1"1/2	1"	36,0	22,0	55	250
DA-RMF1.1/2X1.1/4J	LONG	1"1/2	1"1/4	58,0	22,0	55	250
DA-RMF22X14JE	COURT	M22X150	M14X150	19,0	9,0	27	400
DA-RMF22X16JE	COURT	M22X150	M16X150	21,0	14,0	27	400
DA-RMFU1/2X3/4JE	LONG	1/2" UNF	3/4" UNF	46,0	14,0	36	315
DA-RMFU1/2X7/8JE	LONG	1/2" UNF	7/8" UNF	46,0	14,0	36	315
DA-RMFU1/2X1.1/16JE	LONG	1/2" UNF	1"1/16 UN	46,0	14,0	36	315

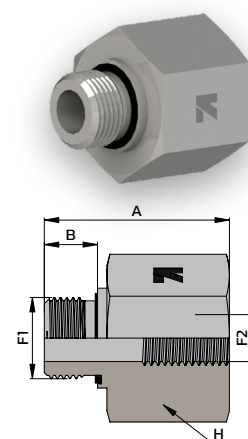

UNION FEMELLE BSP

Référence	Ø Tube (mm)	F1	F2	A	H	PN (bar)
DA-UFG06L1/8	6L	M12X150	1/8"	26,0	14	315
DA-UFG06L1/4	6L	M12X150	1/4"	31,0	19	315
DA-UFG08L1/4	8L	M14X150	1/4"	31,0	19	315
DA-UFG08L3/8	8L	M14X150	3/8"	32,0	24	315
DA-UFG08L1/2	8L	M14X150	1/2"	36,0	27	315
DA-UFG10L1/4	10L	M16X150	1/4"	32,0	19	315
DA-UFG10L3/8	10L	M16X150	3/8"	33,0	24	315
DA-UFG10L1/2	10L	M16X150	1/2"	37,0	27	315
DA-UFG12L3/8	12L	M18X150	3/8"	33,0	24	315
DA-UFG12L1/2	12L	M18X150	1/2"	37,0	27	315
DA-UFG15L1/2	15L	M22X150	1/2"	38,0	27	315
DA-UFG18L1/2	18L	M26X150	1/2"	38,0	27	315
DA-UFG18L3/8	18L	M26X150	3/8"	34,0	27	315
DA-UFG22L3/4	22L	M30X200	3/4"	43,0	36	160
DA-UFG28L1	28L	M36X200	1"	46,0	41	160
DA-UFG35L1.1/4	35L	M45X200	1"1/4	51,5	55	160
DA-UFG42L1.1/2	42L	M52X200	1"1/2	54,0	60	160
DA-UFG06S1/4	6S	M14X150	1/4"	33,0	19	400
DA-UFG08S1/4	8S	M16X150	1/4"	33,0	19	400
DA-UFG10S3/8	10S	M18X150	3/8"	34,0	24	400
DA-UFG12S3/8	12S	M20X150	3/8"	34,0	24	400
DA-UFG12S1/2	12S	M20X150	1/2"	38,0	30	400
DA-UFG14S1/2	14S	M22X150	1/2"	40,0	30	400
DA-UFG16S1/2	16S	M24X150	1/2"	40,0	30	400
DA-UFG20S3/4	20S	M30X200	3/4"	45,0	36	315
DA-UFG25S1	25S	M36X200	1"	50,0	41	315
DA-UFG30S1.1/4	30S	M42X200	1"1/4	56,0	55	315
DA-UFG38S1.1/2	38S	M52X200	1"1/2	60,0	60	250
DA-UFM08LM12	8L	M14X150	M12X150	33,0	19	315
DA-UFM10LM12	10L	M16X150	M12X150	27,0	19	315
DA-UFM10LM14	10L	M16X150	M14X150	-	-	315
DA-UFM10LM22	10L	M16X150	M22X150	-	-	315
DA-UFM12LM14	10L	M18X150	M14X150	37,0	27	315
DA-UFM15LM14	15L	M22X150	M14X150	26,0	21	315
DA-UFM15LM18	15L	M22X150	M18X150	35,0	24	315
DA-UFM15LM22	15L	M22X150	M22X150	-	-	315

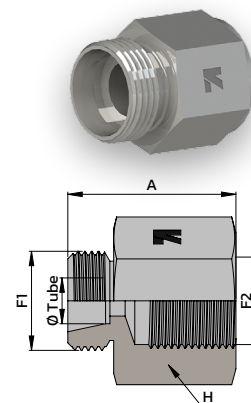

UNION FEMELLE BSPP MANO

Référence	Ø Tube (mm)	F1	F2	A	L	H	PN (bar)
DA-UF06L1/4MANO	6L	M12X150	1/4"	22,0	7,5	19	500
DA-UF08L1/4MANO	8L	M14X150	1/4"	29,0	14,5	19	500
DA-UF10L1/4MANO	10L	M16X150	1/4"	23,0	8,5	19	500
DA-UF12L1/4MANO	12L	M18X150	1/4"	23,0	8,5	19	400
DA-UF06S1/2MANO	6S	M14X150	1/2"	31,0	11,0	27	630
DA-UF08S1/2MANO	8S	M16X150	1/2"	31,0	11,0	27	630
DA-UF10S1/2MANO	10S	M18X150	1/2"	30,5	10,5	27	630
DA-UF12S1/2MANO	12S	M20X150	1/2"	30,5	10,5	27	630

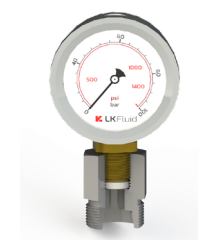
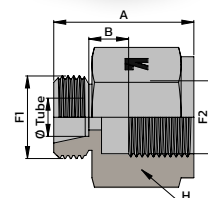
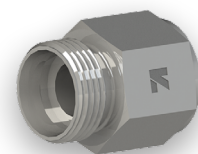

ADAPTATEUR TOURNANT DKO / BSPP MANO

Référence	Ø Tube (mm)	F1	F2	A	L	H	H1	PN (bar)
DA-ADO6L1/4MANO	6L	M12X150	1/4"	36,0	21,5	19	14	500
DA-ADO8L1/4MANO	8L	M14X150	1/4"	36,0	21,5	19	17	500
DA-AD10L1/4MANO	10L	M16X150	1/4"	36,0	21,5	19	19	500
DA-AD12L1/4MANO	12L	M18X150	1/4"	36,5	22,0	19	22	400
DA-ADO6S1/2MANO	6S	M14X150	1/2"	43,0	23,0	27	17	630
DA-ADO8S1/4MANO	8S	M16X150	1/4"	35,5	21,0	19	19	630
DA-ADO8S1/2MANO	8S	M16X150	1/2"	43,5	23,5	27	19	630
DA-AD10S1/2MANO	10S	M18X150	1/2"	44,0	24,0	27	22	630
DA-AD12S1/2MANO	12S	M20X150	1/2"	44,0	24,0	27	24	630

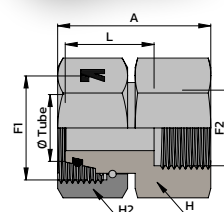
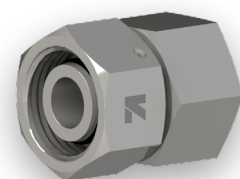

BAGUE D'ETANCHEITE POUR MANOMETRE

Référence	Série	Diamètre	D1	D2	E
DA-B1/4MANO	L	1/4	11,3	6,0	4,5
DA-B1/2MANO	S	1/2	18,5	12,2	5,0

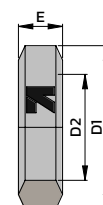

BLOC DE PRE-SERTISSAGE

Référence	Ø Tube (mm)	F
DA-BL06L	6L	M12X150
DA-BL08L	8L	M14X150
DA-BL10L	10L	M16X150
DA-BL12L	12L	M18X150
DA-BL15L	15L	M22X150
DA-BL18L	18L	M26X150
DA-BL22L	22L	M30X200
DA-BL28L	28L	M36X200
DA-BL35L	35L	M45X200
DA-BL42L	42L	M52X200
DA-BL06S	6S	M14X150
DA-BL08S	8S	M16X150
DA-BL10S	10S	M18X150
DA-BL12S	12S	M20X150
DA-BL14S	14S	M22X150
DA-BL16S	16S	M24X150
DA-BL20S	20S	M30X200
DA-BL25S	25S	M36X200
DA-BL30S	30S	M42X200
DA-BL38S	38S	M52X200
DA-BL04LL	4LL	M8X100
DA-BL06LL	6LL	M10X100
DA-BL08LL	8LL	M12X100
DA-BL10LL	10LL	M14X100
DA-BL12LL	12LL	M16X100

Voir **PROCÉDURE D'UTILISATION** à la page - **DIN 7** -

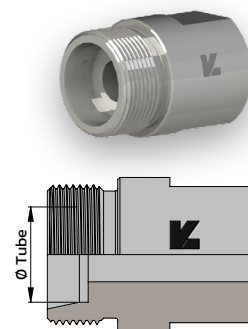



DMH, FOURNISSEUR DE CONNECTIQUE HYDRAULIQUE

Chez DMH France, nous nous engageons à fournir à nos clients les solutions les plus adaptées à leur besoin, grâce à un service efficace et dans les meilleurs délais.

Pour cela, nous avons développé la marque LK Fluid, une gamme complète de connecteurs hydraulique de haute qualité.

Les produits LK Fluid bénéficient d'une capacité de stockage de plus de 5000 m², permettant une forte disponibilité et de faibles délais de livraison.

Ciblant principalement le marché européen, DMH fournit les grands constructeurs ainsi que les spécialistes de la distribution (machines agricoles, poids lourds, industries, etc.).

Nos 20 années d'expérience nous ont permis de construire de forts partenariats avec nos clients, les accompagnant dans leur poursuite d'excellence.

UNE GAMME COMPLETE DE PRODUITS HYDRAULIQUES



DMH ■ Agence de Nantes

6 rue Jupiter 44470 Carquefou FRANCE
T +33 (0)2 40 25 77 27
distribution@dmhfrance.com
oem@dmhfrance.com

DMH ■ Agence de Lyon

5 av. Lionel Terray 69330 Meyzieu FRANCE
T +33 (0)4 37 25 84 50
infolyon@dmhfrance.com

www.dmhfrance.com



DMH France certifiée ISO 9001:2015

